

Case study 2

Analysis of Pile Groups of *Dashwood House* in London by the Program *ELPLA*



*R. Herrmann*¹/*M. El Gendy*²/*F. Hattab*³



GEOTEC Software Inc.
PO Box 14001 Richmond Road PO, Calgary AB, Canada T3E 7Y7
Tele.:+1(587) 332-3323
geotec@geotecsoftware.com
www.geotecsoftware.com

2022

¹Prof. Geotechnical Institute, Siegen university, Germany. Email: richard.herrmann@uni-siegen.de

² Prof. Faculty of Engineering, Suez Canal University, Egypt. Email: melgendy@elpla.com

³ Dip. - Ing.

Content

Page

2	Case study 2: Pile Groups of <i>Dashwood House</i> in London	4
2.1	General	4
2.2	FE-Net	5
2.3	Pile and raft material	5
2.4	Soil properties	6
2.4.1	Undrained cohesion.....	6
2.4.2	Poisson's ratio.....	6
2.4.3	Modulus of elasticity of London clay	6
2.4.4	Limit pile load Q_l	7
2.4.5	Groundwater.....	7
2.4.6	Boring log	7
2.5	Loads	9
2.6	Analysis of the pile groups.....	9
2.7	Results.....	10
2.7.1	Settlements	10
2.7.2	Contact pressures	15
2.7.3	Pile loads	21
2.7.4	Tabulation of the results.....	29
2.8	Evaluation	30
2.8.1	Maximum settlements	30
2.8.2	Bearing factors α_{kPP}	30
2.8.3	Pile reaction and raft reaction	31
2.8.4	Available measurements and analyses	32
2.8.5	Discussion of Results	32
2.8.6	Conclusions.....	36
2.8.7	Recommendations	36
2.9	References.....	38

Preface

As a practical example of piled raft and pile groups by *ELPLA*, a case is dealt with in order to assess the accuracy of the different calculation methods of piled raft and pile groups. The case under study is a high-rise building in London (*Dashwood House*), which is examined as special case of piled raft, when no interaction between pile-raft and raft-soil is taken into account. The tower stands on pile groups. Using the existing field test data of the subsoil and the field results of the raft settlements and pile loads, this case study provides a good opportunity to evaluate the various calculation methods available in *ELPLA*.

The case was examined by *Hattab* (2007) in a thesis under the supervision of:

Prof. *R Herrman*

Professor of Geotechnical and Foundation Engineering at the Siegen University

and

Prof. *M El Gendy*

Professor of Geotechnical and Foundation Engineering at Port Said University

The original work of this case study was in German. Editing and translation of the case study are carried out with the help of

Eng. *Y. El Gendy*

GEOTEC Software Inc.

.

2 Case study 2: Pile Groups of *Dashwood House* in London

2.1 General

Hong et al. (1999) applied a method for analyzing large vertically loaded pile groups using load-transfer curves (*NPRLT*) on the piled raft of *Dashwood House*. They compared the computed settlement with that of the field measurement reported by *Hooper* (1979). In this case study, the computed and measured settlement of this piled raft is used to verify the methods for analyzing piled raft and pile groups available in *ELPLA*.

Dashwood House (Figure 2-1) is a high building of 15-storey floors with a single storey basement located in North London, England. The building is 61 [m] high. The foundation of *Dashwood House* is a rectangular piled raft of area 33 [m] by 31.5 [m]. The building load including the raft weight is 274 [MN]. A total of 462 bored piles are located under the raft. All piles have a length of $l = 15$ [m] and a diameter of $D = 0.485$ [m]. Piles are arranged on a square grid of 1.5 [m] interval. The subsoil at the building location consists of 8 [m] of fill, sand and gravel, followed by London clay. The raft is founded on gravel about 1 [m] above the upper clay surface. In their analysis for simplicity, *Hong et al.* (1999) considered the raft resets on the London clay directly.

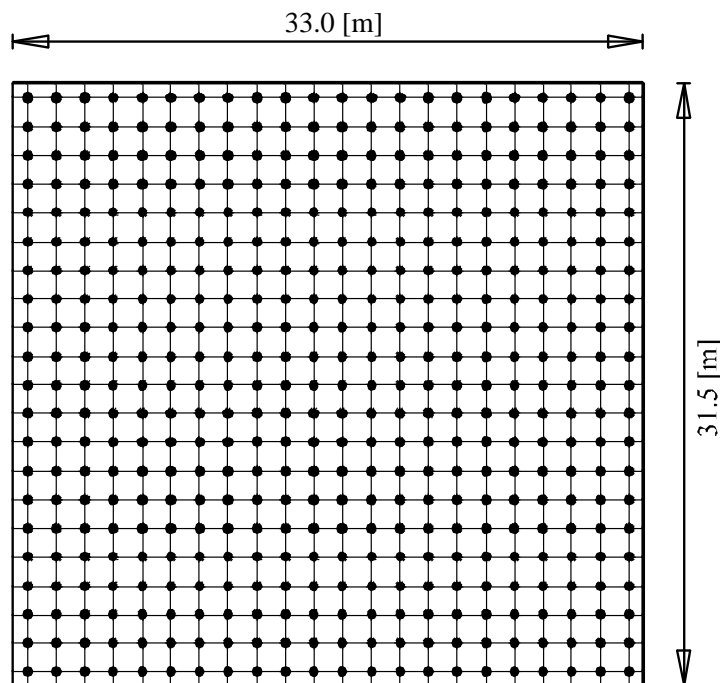

Figure 2-1 *Dashwood House* raft with piles

2.2 FE-Net

The raft with the dimensions 33 [m] × 31.5 [m] is to be calculated. It is divided into elements with a maximum length of 1.5 [m] in x- and y-directions, as shown in Figure 2-2. The piles are divided into line elements with a length of 3.75 [m].

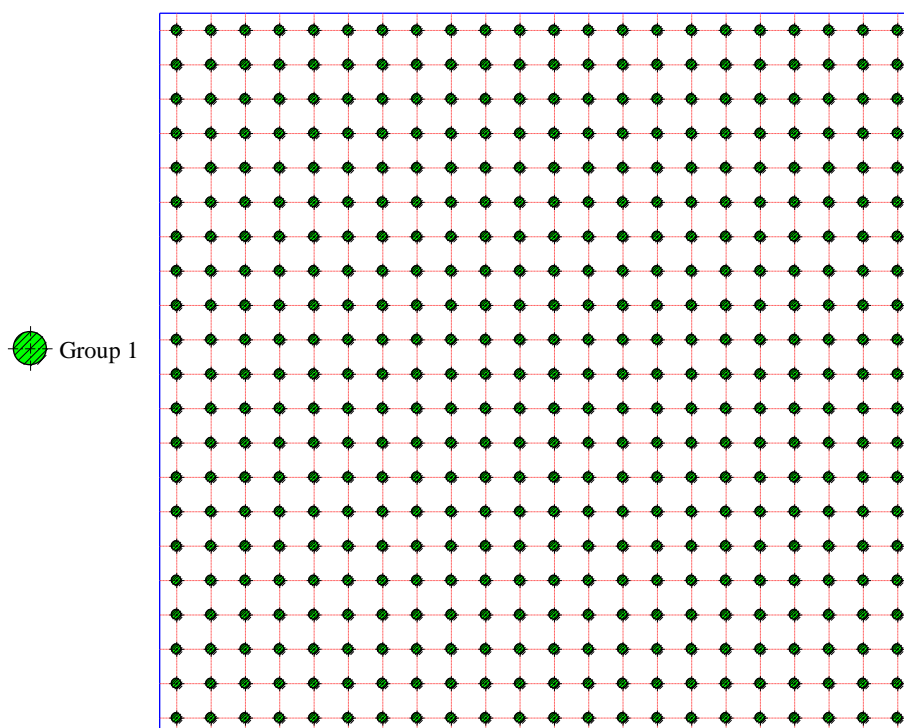

Figure 2-2 FE-Net of the raft with piles

2.3 Pile and raft material

The raft thickness is 0.9 [m]. All piles are equal in diameter and length, where pile diameter is 0.485 [m], while pile length is 15 [m]. The following values are used for pile and raft material:

For the raft:

Modulus of elasticity	E_p	=	20 000	[MN/m ²]
Poisson's ratio	ν_p	=	0.25	[-]
Unit weight	γ_b	=	25	[kN/m ³]

For the piles:

Modulus of elasticity	E_p	=	30 000	[MN/m ²]
Unit weight	γ_b	=	25	[kN/m ³]

2.4 Soil properties

The following section describes all soil parameters and constants, those used to carry out the analysis by *ELPLA* and other selected methods for comparison for London clay, which is classified as overconsolidated clay.

2.4.1 Undrained cohesion

The undrained cohesion of London clay increases with depth and can be approximated according to *Hong et al. (1999)* by the following linear relation:

$$c_u = 150 + 6.67z \quad (2.1)$$

where:

- c_u Undrained cohesion of London clay [kN/m²]
- z Depth measured from the clay surface [m]

2.4.2 Poisson's ratio

Poisson's ratio of London clay is taken to be $v_s = 0.25$ [-].

2.4.3 Modulus of elasticity of London clay

Hong et al. (1999) used a ratio of 200 between the shear modulus G and the undrained cohesion C_u to get a variable shear modulus of the soil.

$$G = 200c_u = 200(150 + 6.67z) \quad (2.2)$$

The relationship between the shear modulus G and modulus of elasticity E is given by:

$$G = \frac{E}{2(1 + v_s)} \quad (2.3)$$

Substituting Eq. (2.2) into Eq. (2.3) and taking *Poisson's* ratio of the clay $v_s = 0.25$ [-] leads to:

$$E = E_o(1 + 0.0445z) \quad (2.4)$$

where:

- G Shear modulus [kN/m²]
- E Modulus of elasticity of London clay [kN/m²]
- v_s *Poisson's* ratio of the soil [-]
- E_o Initial Modulus of Compressibility, $E_{so} = 75000$ [kN/m²]

2.4.4 Limit pile load Q_l

The mean undrained cohesion c_u of the London clay is taken as $c_u = 200$ [kN/m²]. *Russo* (1998) suggested a shaft friction of 180 [kN/m²] for undrained shear strength of 200 [kN/m²]. To carry out the analysis using a hyperbolic function, a shaft friction of $\tau = 180$ [kN/m²] is assumed. The limit pile load Q_l for a pile of length = 15 [m] can be calculated as follows:

$$Q_l = \tau \times \pi \times D \times l = 180 \times \pi \times 0.485 \times 15 = 4114 \text{ [kN]} = 4.1 \text{ [MN]} \quad (2.5)$$

where:

- Q_l Limit pile load, [MN]
- τ Limit shaft friction, $\tau = 180$ [kN/m²]
- D Pile diameter, [m]
- l Pile length, [m]

The limit pile load Q_l is a geometric parameter of the hyperbolic relationship. In some cases, the value of Q_l is different from the actual ultimate pile load. $Q_l = 1.5$ to $2 Q_u$, where Q_u is the ultimate pile load.

2.4.5 Groundwater

Groundwater in typical London clay lies within 1.0 [m] of the soil surface (*Rickard et al.* (1985)). Groundwater is assumed to be directly under the raft at a depth of 1.0 [m].

2.4.6 Boring log

A soil layer of $H = 100$ [m] thickness is considered. For the calculation, the entire layer of the subsoil, as shown in the borehole profile in Figure 2-3, was assumed to have 10 layers.

Pile Groups of *Dashwood House*

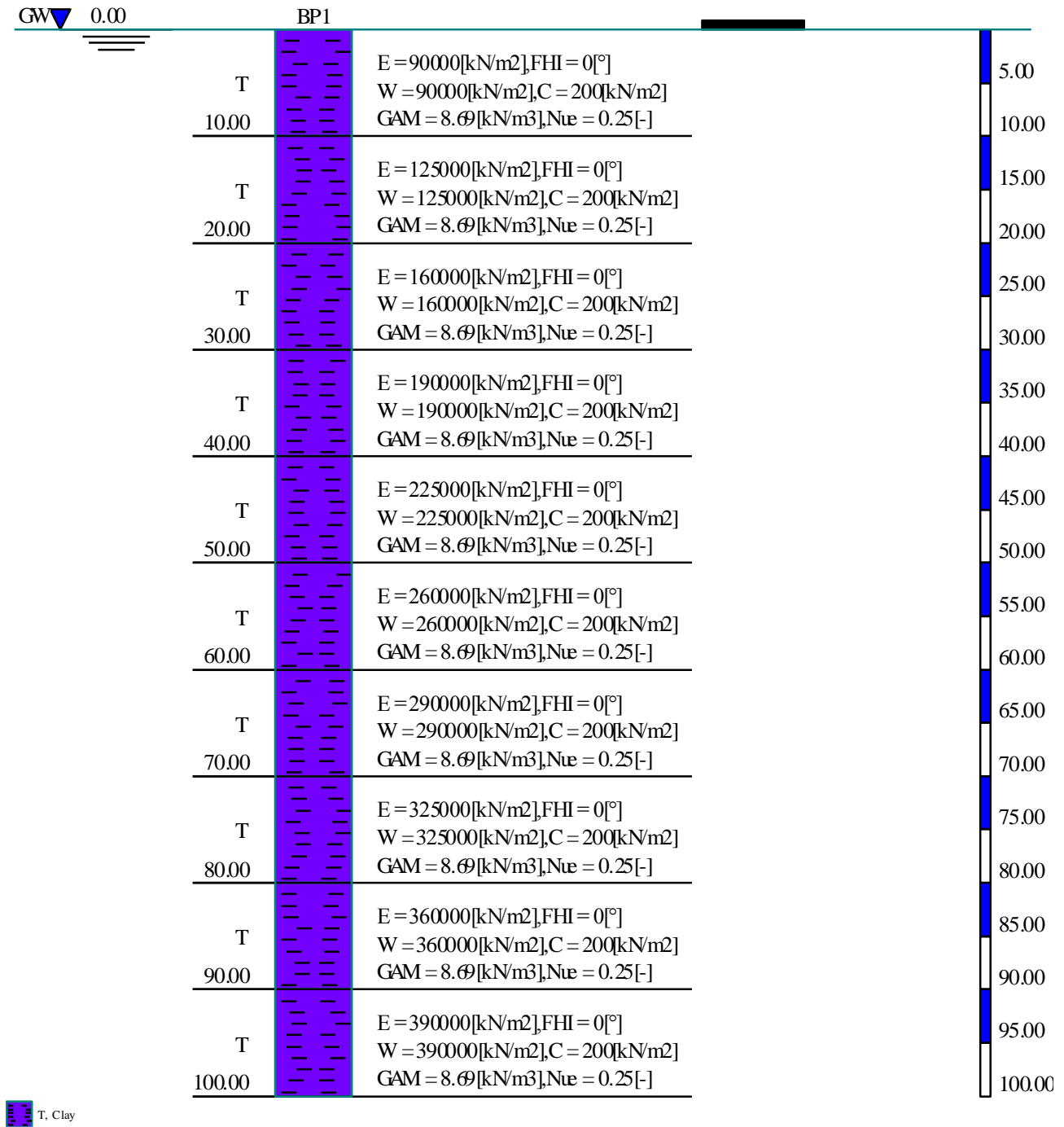

Figure 2-3 Boring log

2.5 Loads

The total load including the own weight of the raft and piles is 274 [MN]. The load is applied as a uniform load of 264 [kN/m²].

2.6 Analysis of the pile groups

To show the difference between the results of the *Dashwood House* pile group in different analyses, a total of 13 analyses are carried out using *ELPLA* as follows:

Table 2-1 Analysis methods of the raft with piles

No.	Method	Linearity of the analysis	Short symbol
1	Linear Contact Pressure	-	-
2	Modulus of Subgrade Reaction	Linear analysis	<i>LPR</i>
3		Nonlinear analysis using Hyperbolic function	<i>NPRH</i>
4		Nonlinear analysis using DIN 4014/ Now DIN 1054	<i>NPRD</i>
5	Modulus of Compressibility for elastic raft	Linear analysis	<i>LPR</i>
6		Nonlinear analysis using Hyperbolic function	<i>NPRH</i>
7		Nonlinear analysis using DIN 4014/ Now DIN 1054	<i>NPRD</i>
8	Modulus of Compressibility for rigid raft	Linear analysis	<i>LPR</i>
9		Nonlinear analysis using Hyperbolic function	<i>NPRH</i>
10		Nonlinear analysis using DIN 4014/ Now DIN 1054	<i>NPRD</i>
11	Rigid free-standing raft	Linear analysis	<i>LPR</i>
12		Nonlinear analysis using Hyperbolic function	<i>NPRH</i>
13		Nonlinear analysis using DIN 4014/ Now DIN 1054	<i>NPRD</i>

Meaning of short symbols *LPR*, *NPRH* and *NPRD* in Table 2-1:

- Nonlinear analysis using DIN 4014 (*NPRD*)
- Nonlinear analysis using Hyperbolic function (*NPRH*)
- Linear analysis (*LPR*)

NPRD was developed by *El Gendy et al.* (2006), while *NPRH* and *LPR* were developed by *El Gendy* (2007a).

2.7 Results

Results of the settlements for the various analyses are presented in contour lines and isometric views from Figure 2-4 to Figure 2-15. Contact pressures are presented as circle diagrams in Figure 2-16 to Figure 2-24. Pile loads are presented as circular diagrams in Figure 2-25 to Figure 2-37.

2.7.1 Settlements

2.7.1.1 Settlements obtained by Modulus of Subgrade Reaction

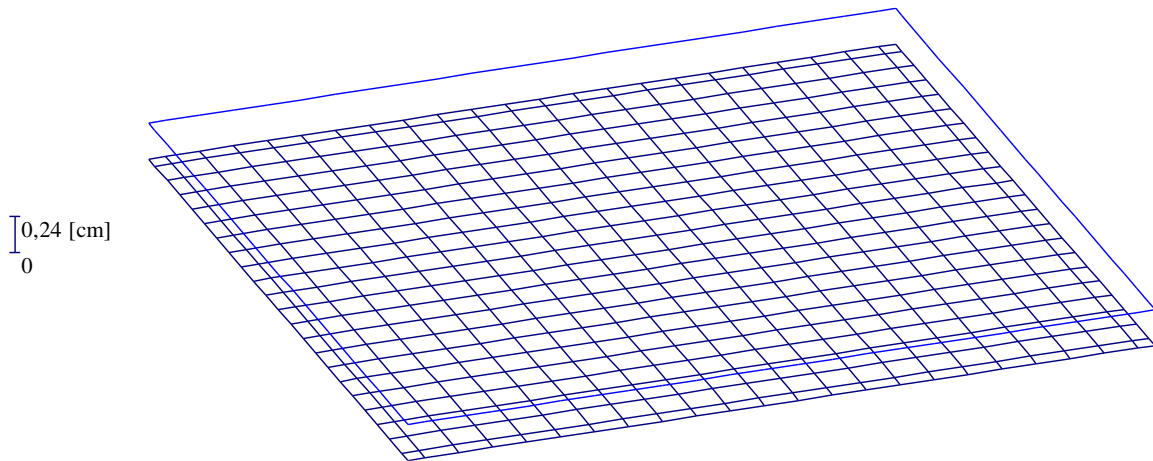

Figure 2-4 Settlements [cm] - *LPR* - Max. $s = 0.24$ [cm], Min. $s = 0.23$ [cm]

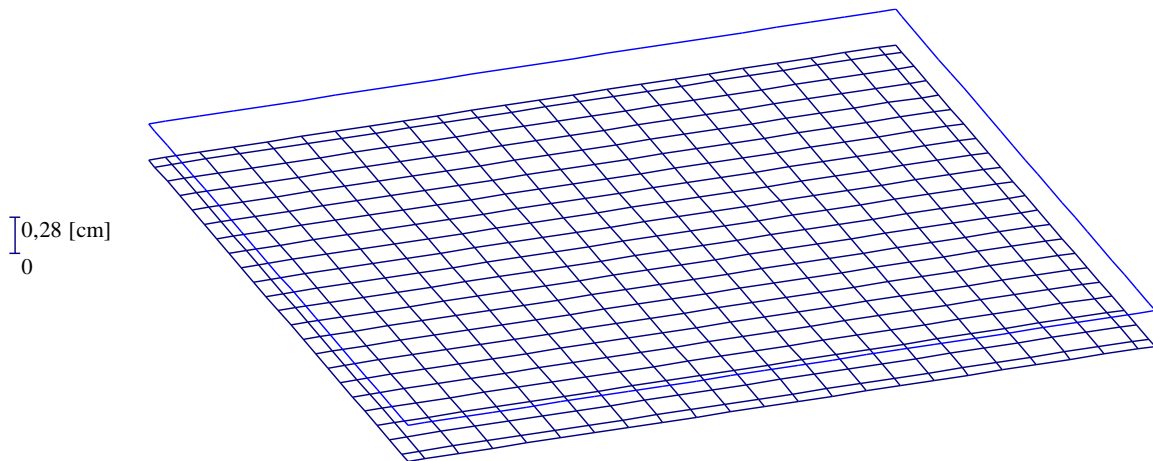

Figure 2-5 Settlements [cm] - *NPRH* - Max. $s = 0.28$ [cm], Min. $s = 0.27$ [cm]

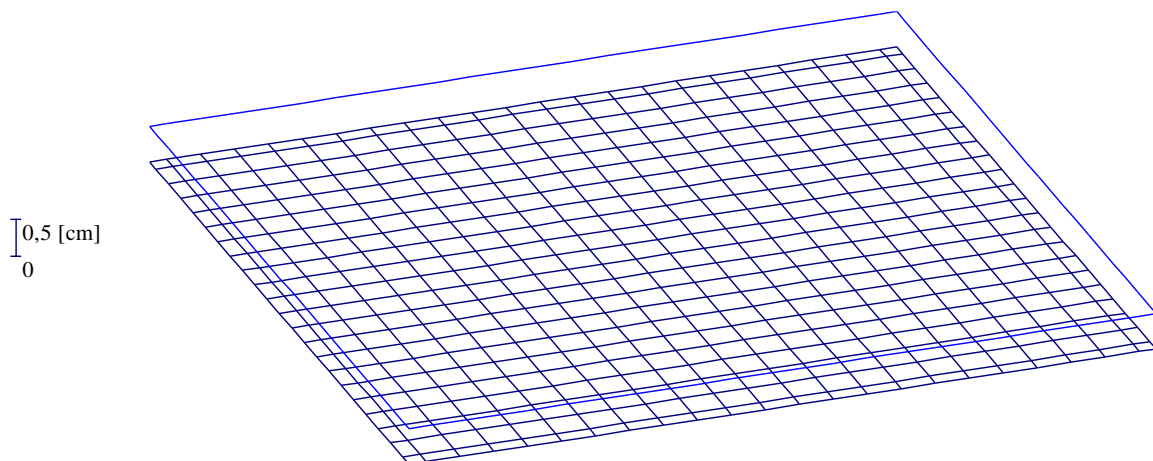

Figure 2-6 Settlements [cm] - *NPRD* - Max. $s = 0.50$ [cm], Min. $s = 0.49$ [cm]

2.7.1.2 Settlements obtained by Modulus of Compressibility for elastic raft

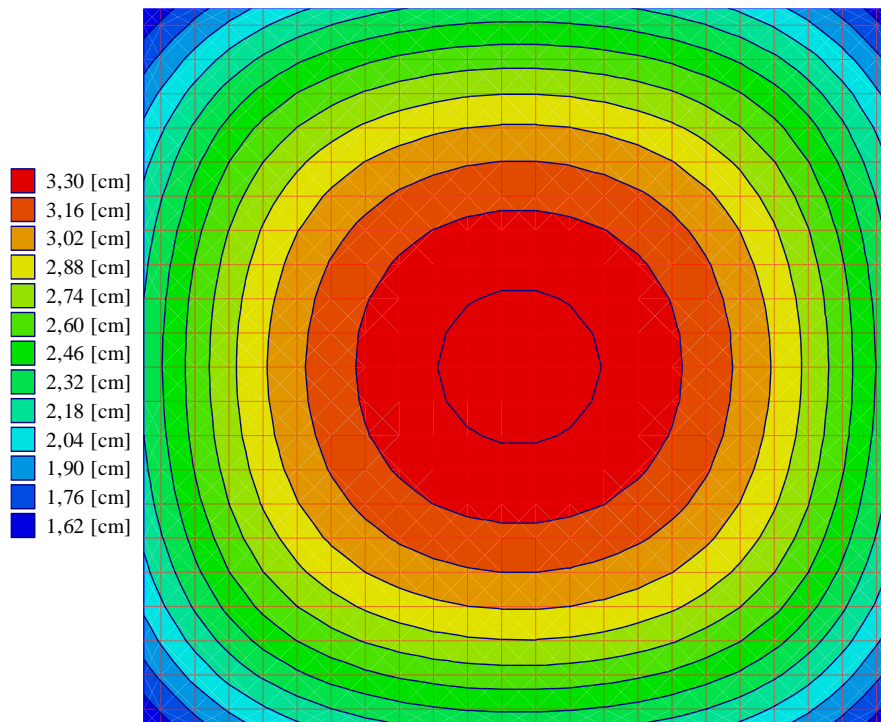

Figure 2-7 Settlements [cm] - *LPR* - Max. $s = 3.41$ [cm], Min. $s = 1.55$ [cm]

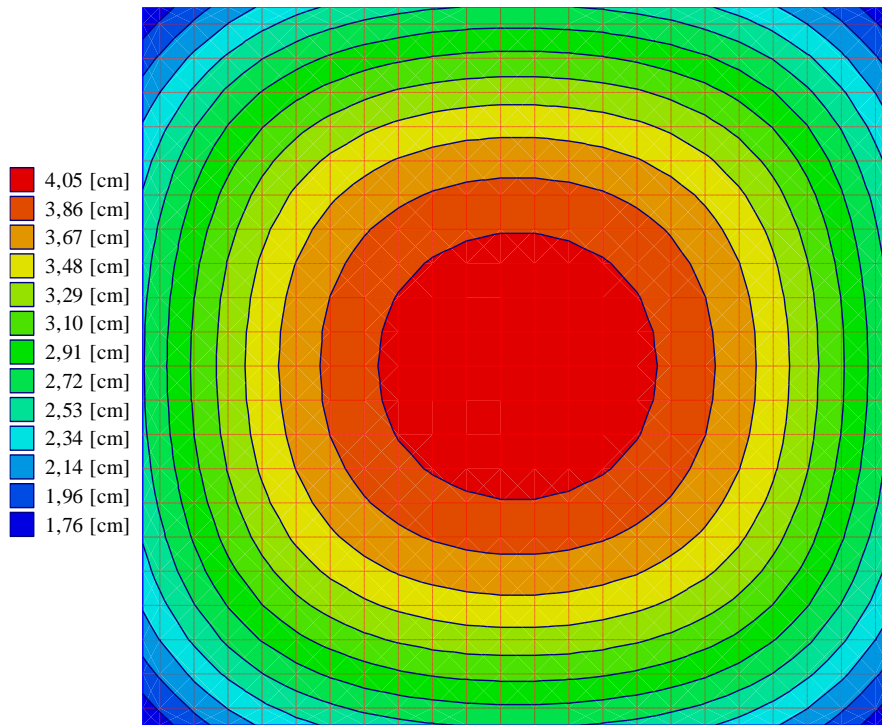

Figure 2-8 Settlements [cm] - *NPRH* - Max. $s = 4.12$ [cm], Min. $s = 1.67$ [cm]

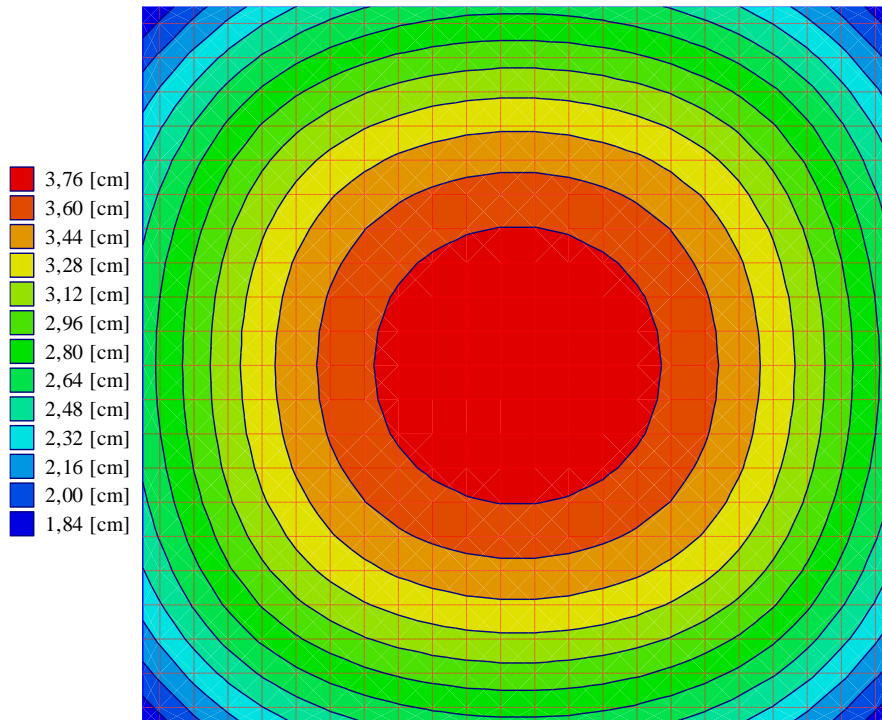

Figure 2-9 Settlements [cm] - *NPRD* - Max. $s = 3.84$ [cm], Min. $s = 1.76$ [cm]

2.7.1.3 Settlements obtained by Modulus of Compressibility for rigid raft

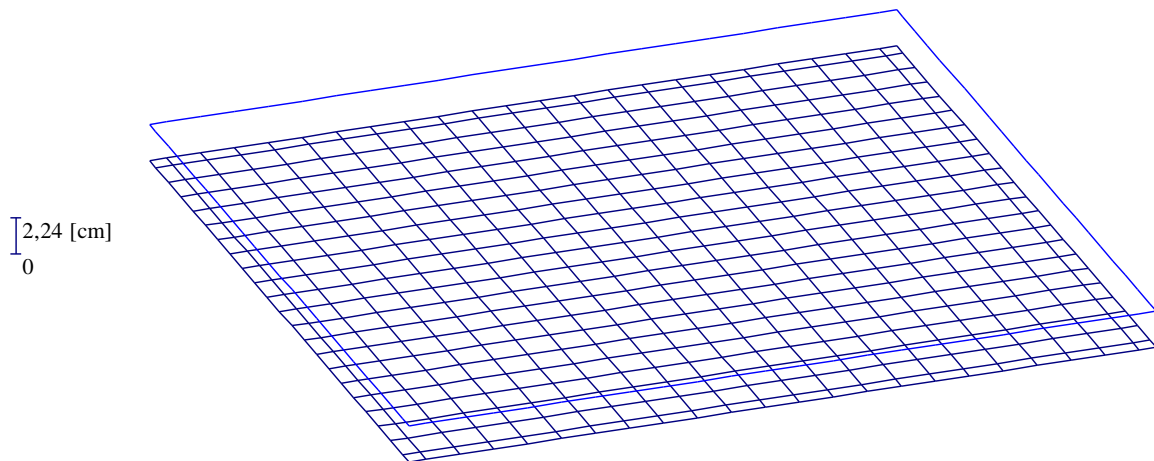

Figure 2-10 Settlements [cm] - *LPR* - $s = 2.24$ [cm]

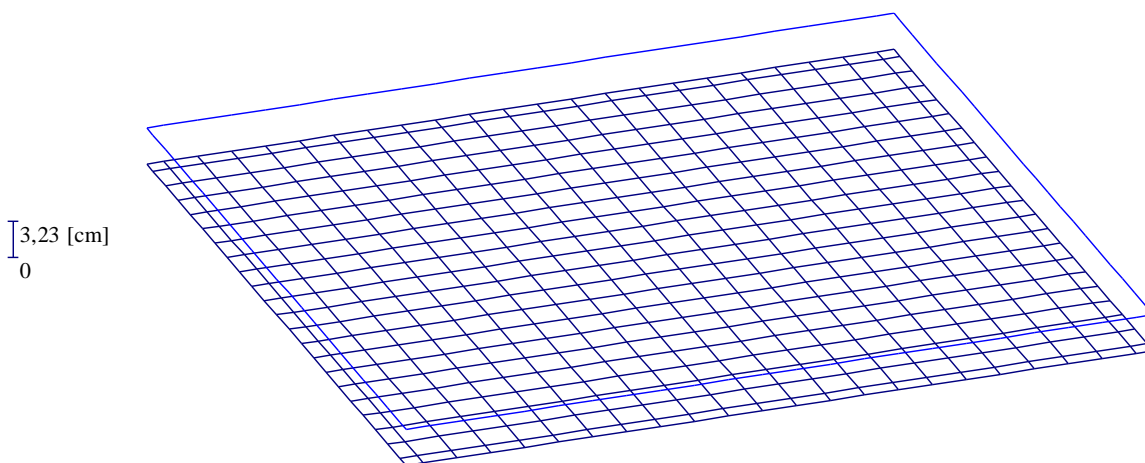

Figure 2-11 Settlements [cm] - *NPRH* - $s = 3.23$ [cm]

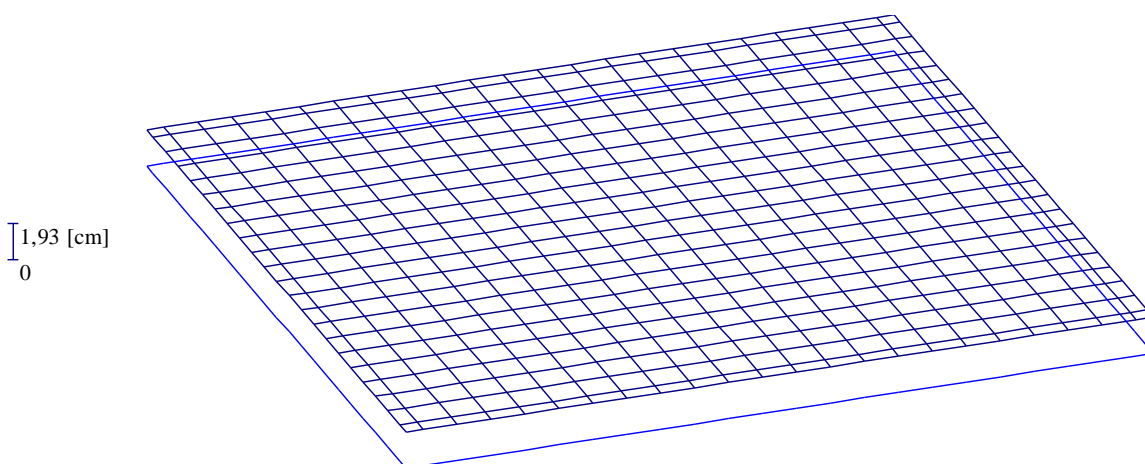

Figure 2-12 Settlements [cm] - *NPRD* - $s = -1.93$ [cm]

2.7.1.4 Settlements obtained by Modulus of Compressibility for free-standing rigid raft

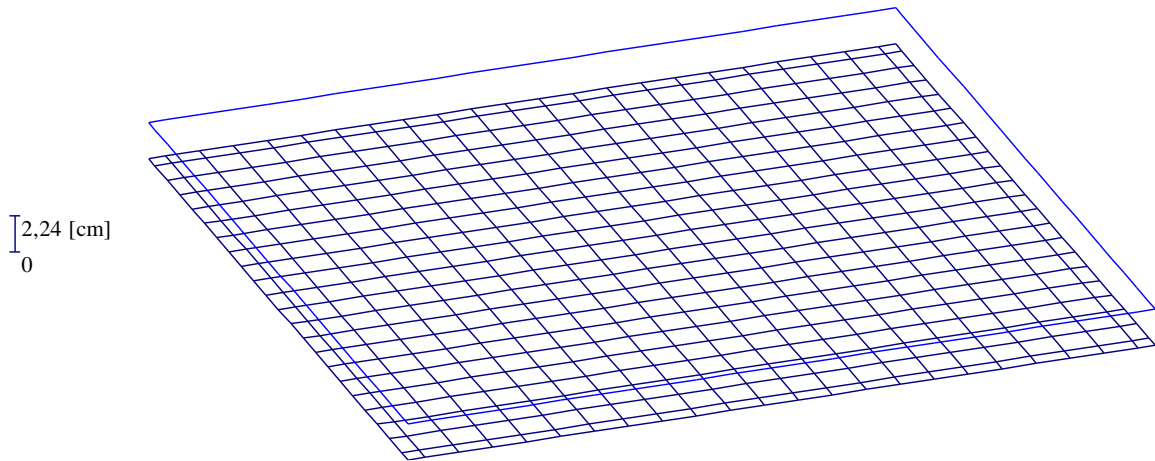

Figure 2-13 Settlements [cm] - *LPR* - $s = 2.24$ [cm]

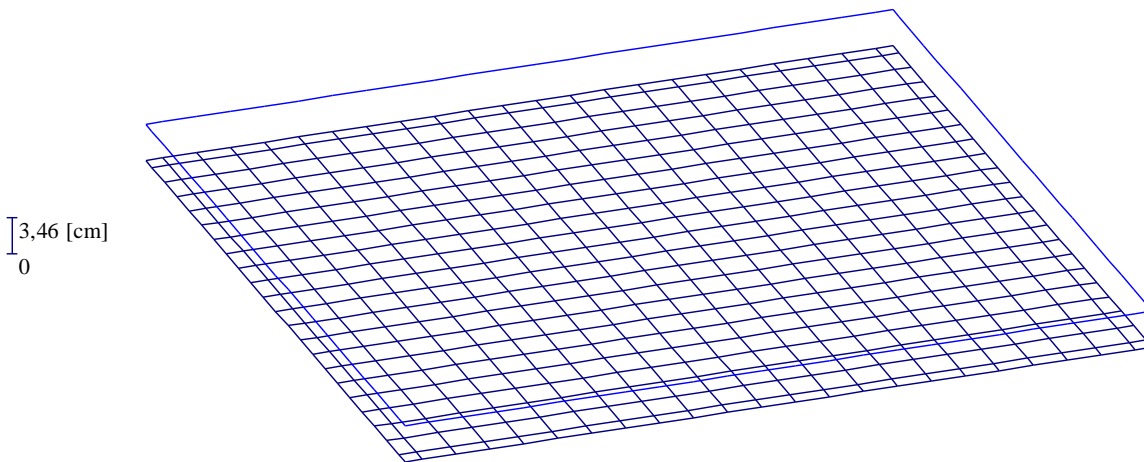

Figure 2-14 Settlements [cm] - *NPRH* - $s = 3.46$ [cm]

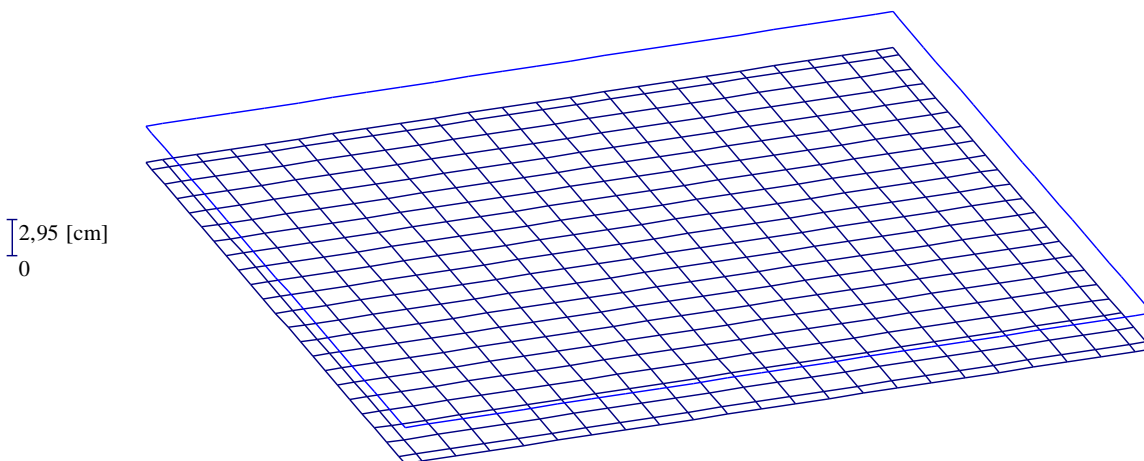

Figure 2-15 Settlements [cm] - *NPRD* - $s = 2.95$ [cm]

2.7.2.2 Contact pressures obtained by Modulus of Compressibility for elastic raft

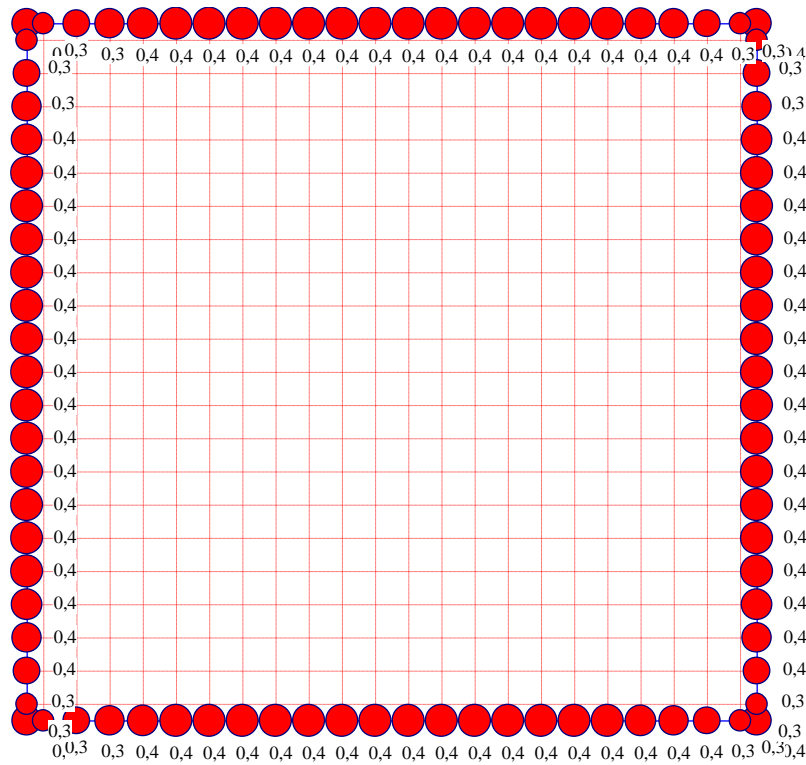

Figure 2-19 Contact pressures [MN/m²] - LPR - Max. $q = 0.4$ [MN/m²] at the edges

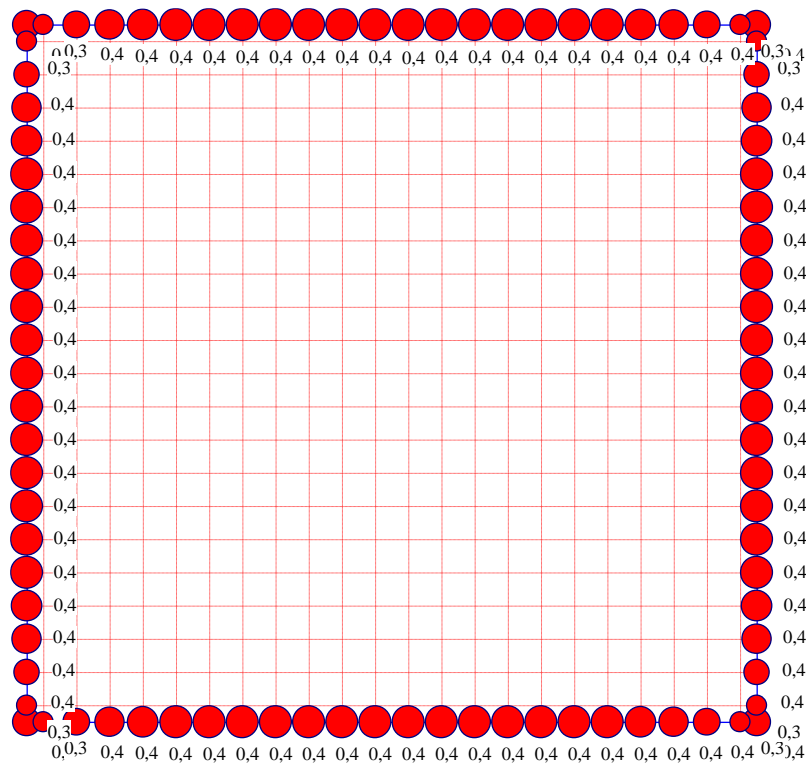

Figure 2-20 Contact pressures [MN/m²] - NPRH - Max. $q = 0.4$ [MN/m²] at the edges

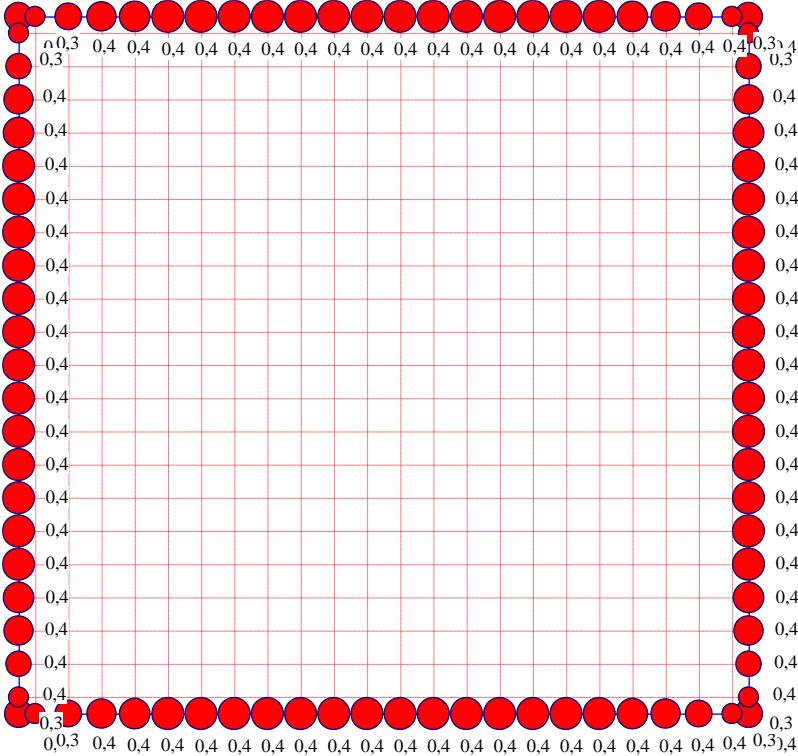

Figure 2-21 Contact pressures [MN/m²] – *NPRD* - Max. $q = 0.4$ [MN/m²] at the edges

2.7.2.3 Contact pressures obtained by Modulus of Compressibility for rigid raft

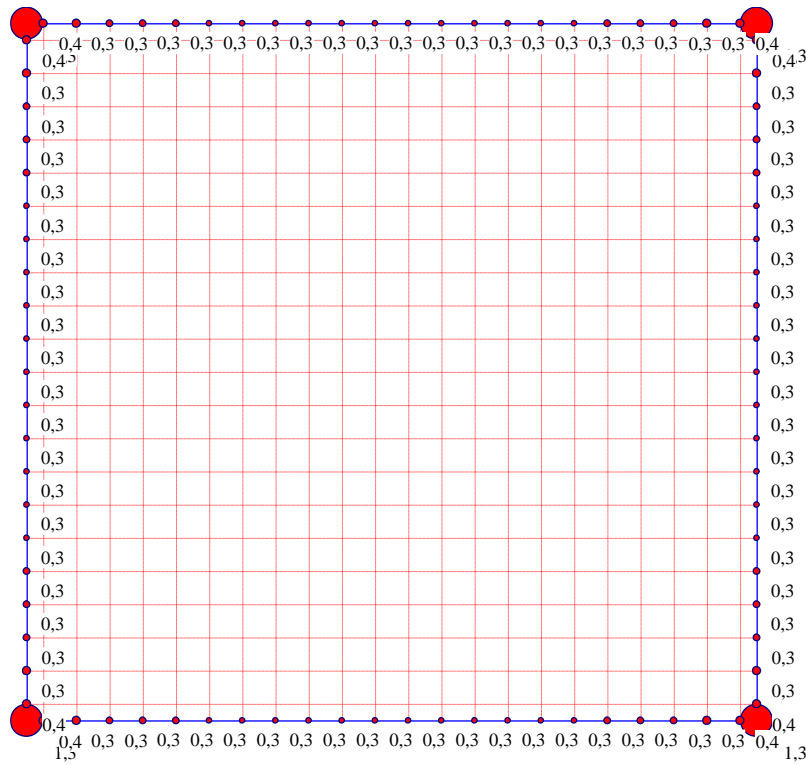

Figure 2-22 Contact pressures [MN/m^2] - LPR - Max. $q = 10.3$ [MN/m^2]

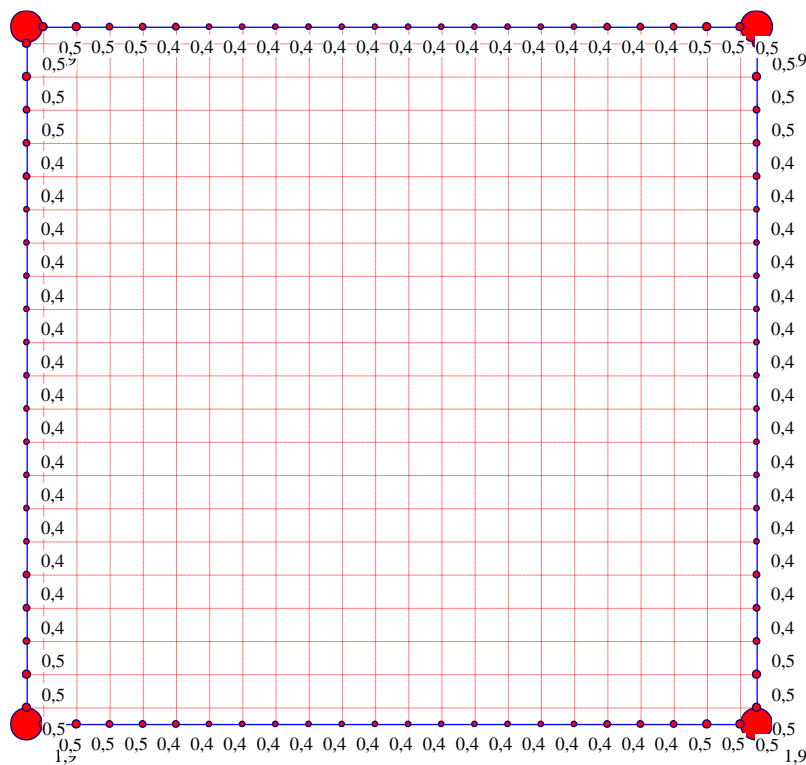

Figure 2-23 Contact pressures [MN/m^2] - NPRH - Max. $q = 1.9$ [MN/m^2] at the edge

2.7.3 Pile loads

2.7.3.1 Pile loads obtained by Linear Contact Pressure

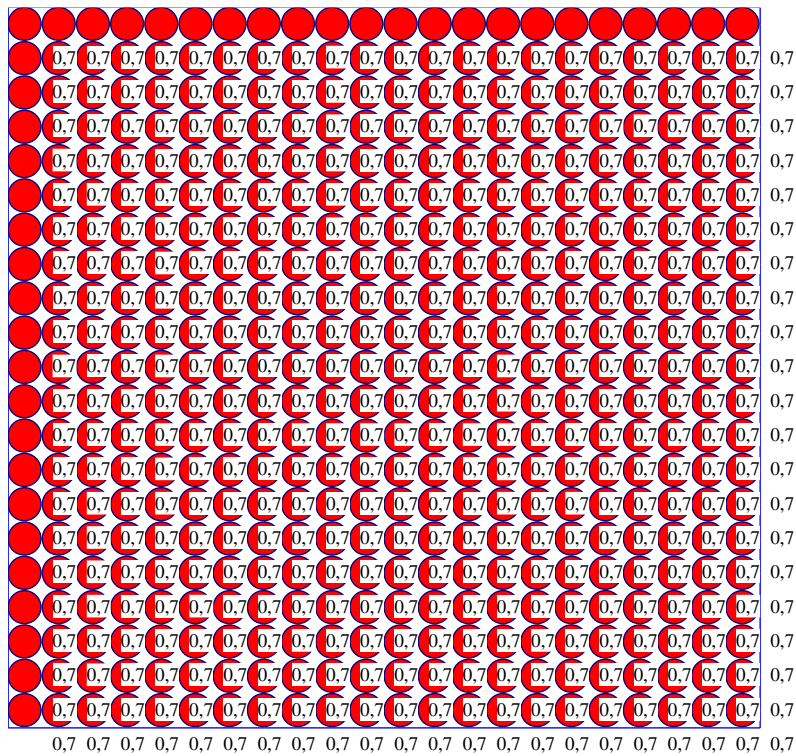

Figure 2-25 Pile loads Ph [MN]

2.7.3.2 *Pile loads obtained by Modulus of Subgrade Reaction*

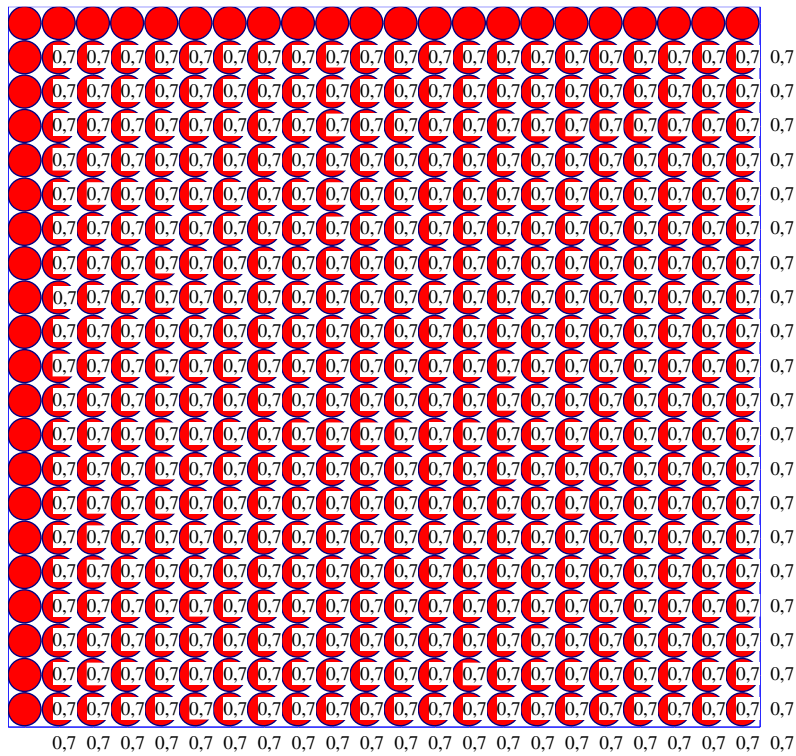

Figure 2-26 Pile loads Ph [MN] - LPR

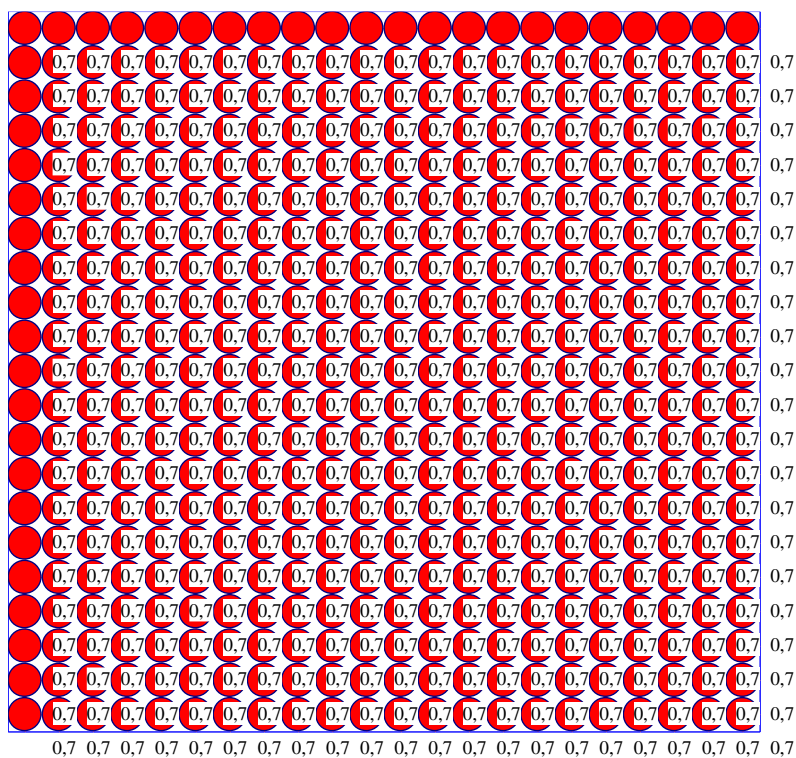

Figure 2-27 Pile loads Ph [MN] - NPRH

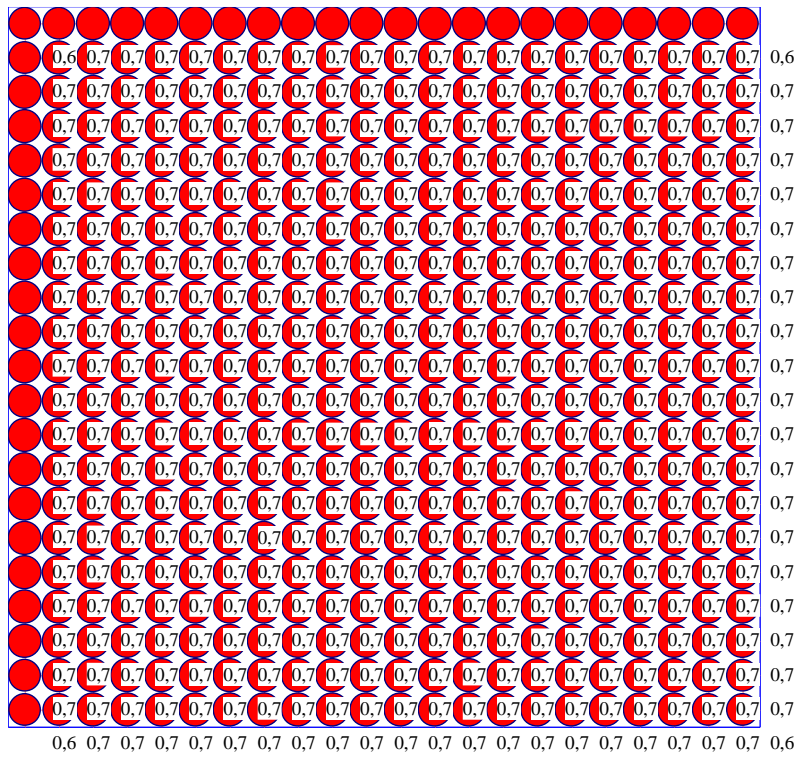

Figure 2-28 Pile loads Ph [MN] - *NPRD*

2.7.3.3 *Pile loads obtained by Modulus of Compressibility for elastic raft*

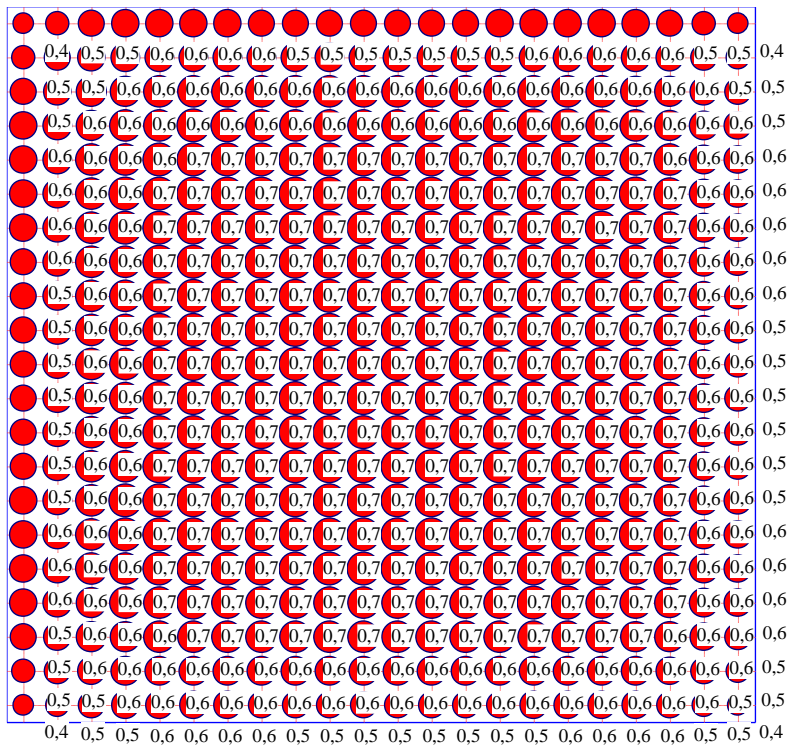

Figure 2-29 Pile loads Ph [MN] - LPR

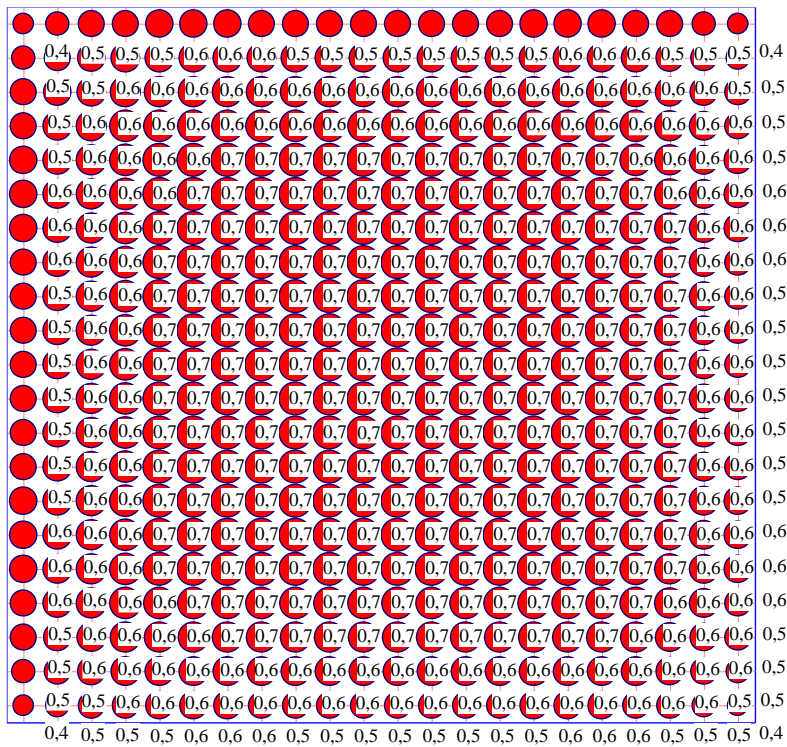

Figure 2-30 Pile loads Ph [MN] - NPRH

Pile Groups of *Dashwood House*

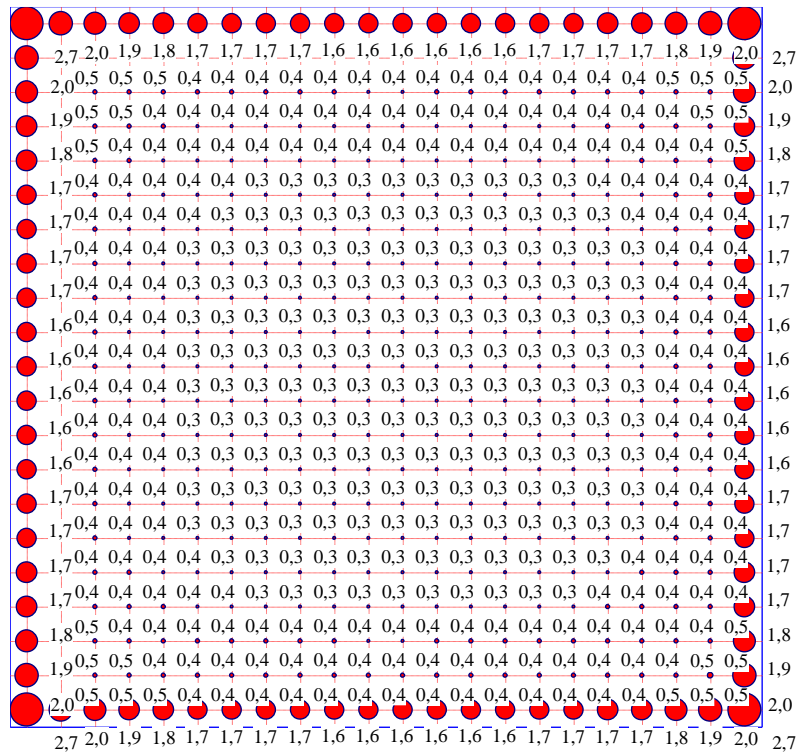

Figure 2-33 Pile loads Ph [MN] – NPRH

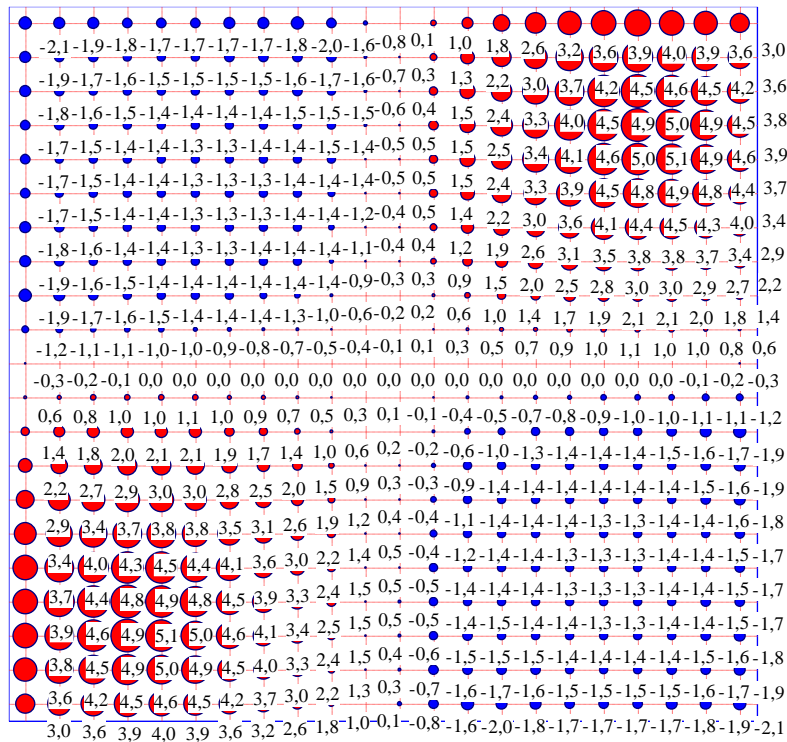

Figure 2-34 Pile loads Ph [MN] - NPRD

2.7.3.5 Pile loads obtained by Modulus of Compressibility for free-sanding raft

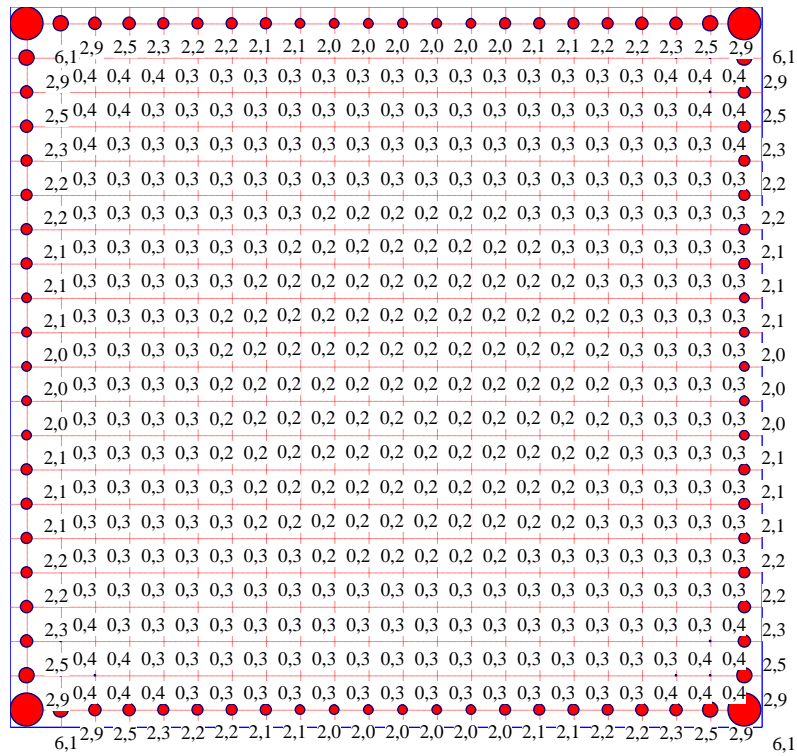

Figure 2-35 Pile loads Ph [MN] - LPR

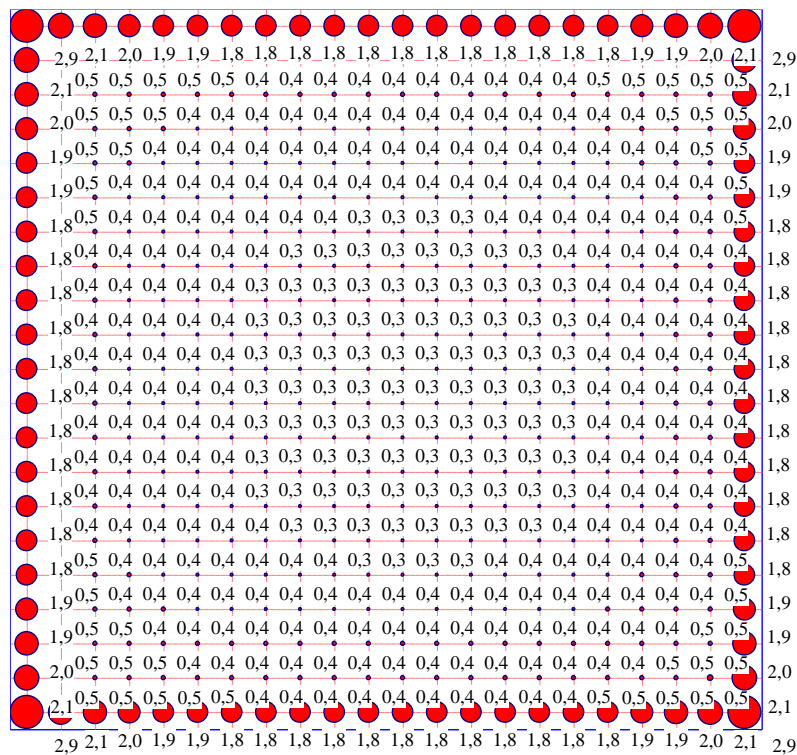

Figure 2-36 Pile loads Ph [MN] - NPRH

Pile Groups of *Dashwood House*

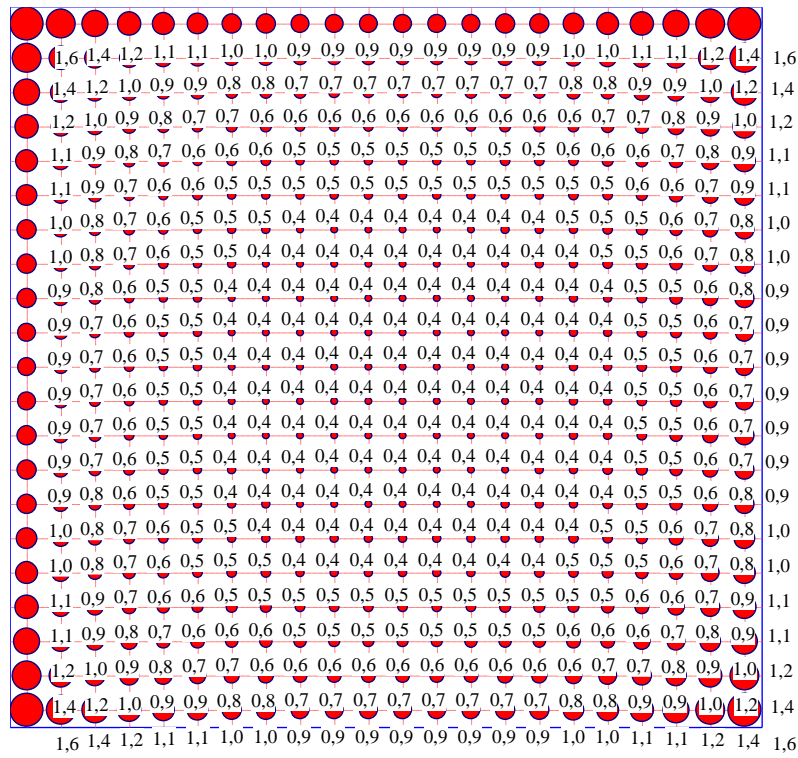

Figure 2-37 Pile loads Ph [MN] – *NPRD*

2.7.4 Tabulation of the results

Table 2-2 compares between the settlements and bearing factors of pile groups of *Dashwood House* for the various analyses. The table also compares the calculated settlements with the measured settlements.

Table 2-2 Comparison between the results of the different analyses

Method	Analysis	Computed settlements [cm]		Measured settlement [cm]	Bearing factor α_{kpp} [%]
		Max.	Min.		
Linear Contact Pressure	-	-	-	3.3	100
Modulus of Subgrade Reaction	<i>LPR</i>	0.24	0.23		99.7
	<i>NPRH</i>	0.28	0.27		99.7
	<i>NPRD</i>	0.50	0.49		99.5
Modulus of Compressibility for elastic raft	<i>LPR</i>	3.41	1.55		94.0
	<i>NPRH</i>	4.12	1.67		93.6
	<i>NPRD</i>	3.84	1.76		96.3
Modulus of Compressibility for rigid raft	<i>LPR</i>	2.24			95.2
	<i>NPRH</i>	3.23			93.1
	<i>NPRD</i>	No convergence			
Modulus of Compressibility for free-standing raft	<i>LPR</i>	2.24		3.3	100
	<i>NPRH</i>	3.46			100
	<i>NPRD</i>	2.95			100

LPR = Linear analysis

NPRH = Nonlinear analysis using Hyperbolic function

NPRD = Nonlinear analysis using DIN 4014

2.8 Evaluation

Figure 2-38 to Figure 2-41 show diagrams of the maximum settlements, bearing factors, pile reaction and raft reaction for pile groups of the *Dashwood House* using different analyses.

2.8.1 Maximum settlements

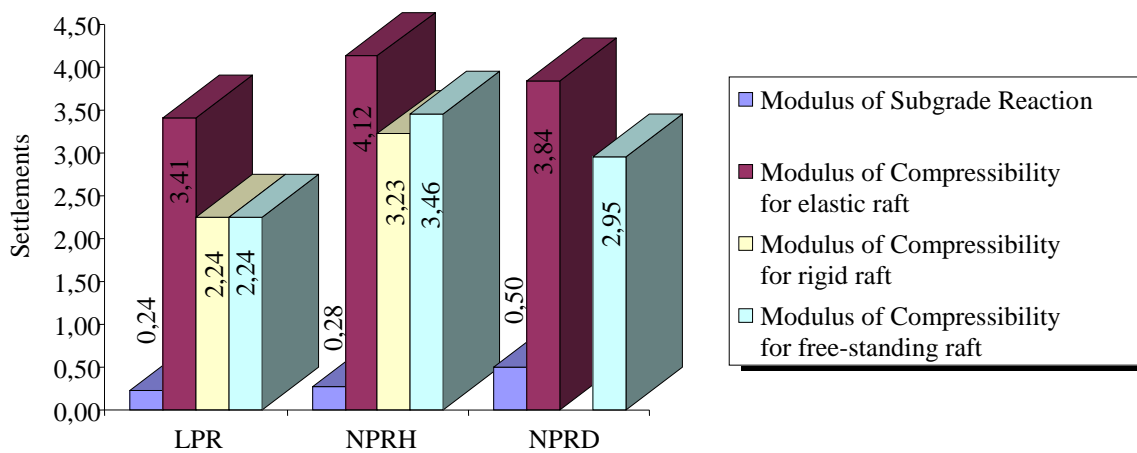

Figure 2-38 Maximum settlements [cm]

2.8.2 Bearing factors α_{kPP}

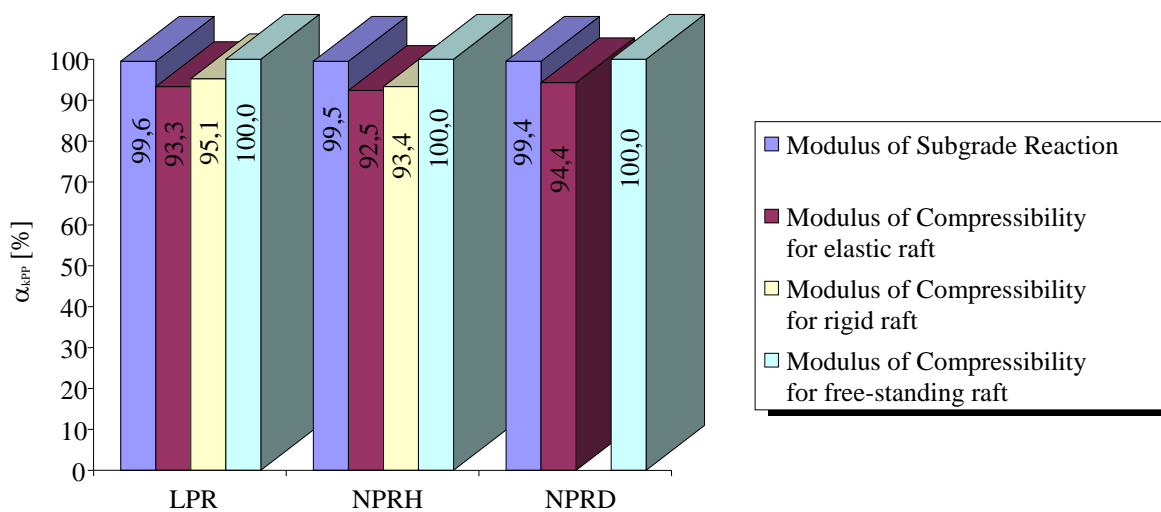

Figure 2-39 Bearing factors α_{kPP} [%]

2.8.3 Pile reaction and raft reaction

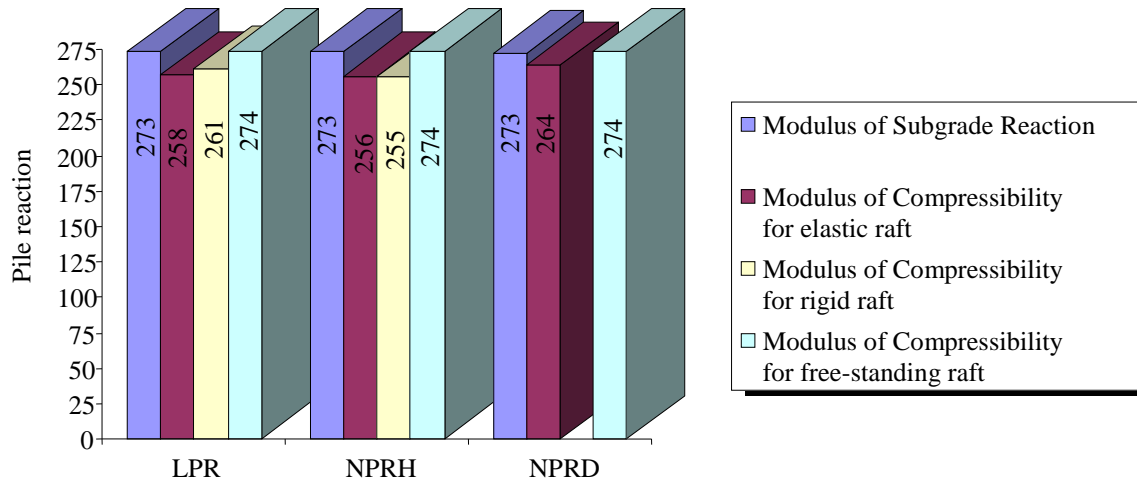

Figure 2-40 Pile reaction [MN]

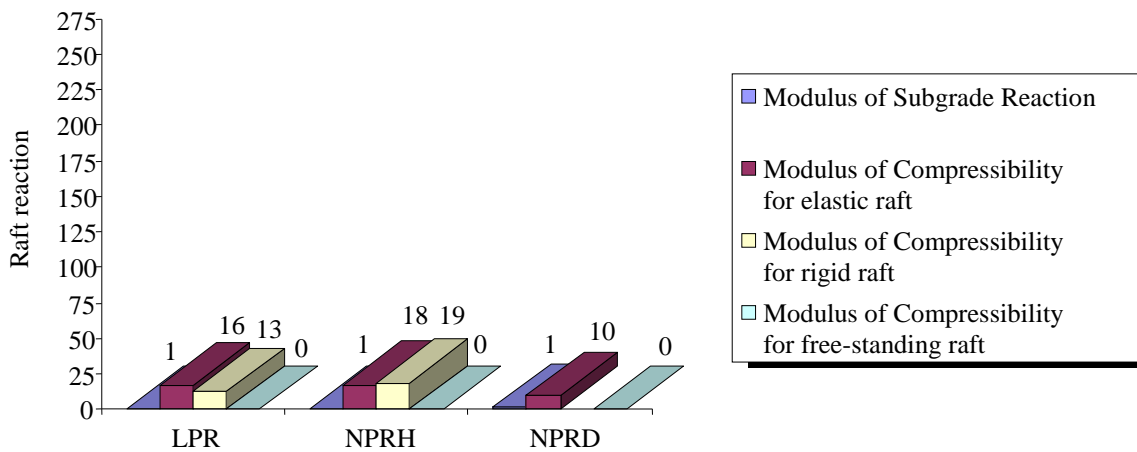

Figure 2-41 Raft reaction [MN]

2.8.4 Available measurements and analyses

Hong et al. (1999) applied a method for the analysis of large vertically loaded pile groups using load-transfer curves (*NPRLT*) on the piled raft of *Dashwood House*. They compared the computed settlement with that of the field measurement reported by *Hooper* (1979). The computed settlement of *Dashwood House* according to *Hong et al.* (1999) with *NPRLT* was 4.0 [cm], while the measured settlement according to *Hooper* (1979) was 3.3 [cm]. The authors obtained good agreement between the measured and calculated results.

El Gendy (2007b) considered the foundation of *Dashwood House* as a rigid pile groups founded on a very deep layer of clay. According to his method for analyzing pile groups using Compression Index C_c and the Initial Void Ratio e_o , the calculated settlement was 2.9 [cm].

2.8.5 Discussion of Results

In most calculations, the behavior of the pile groups of *Dashwood House* is similar to that of the *Stonebridge Tower*. Both have almost the same pile arrangement, loads and soil conditions. The following conclusions can be drawn from the results of the various calculation methods:

2.8.5.1 Linear Contact Pressure

- Due to the symmetry of the system, Linear Contact Pressure gives the same pile load on every pile.
- The bearing factor obtained by Linear Contact Pressure is 100%, while for all calculation methods, it is between 93% and 100%.
- The pile loads obtained by Linear Contact Pressure of such a system are similar to those obtained by Modulus of Subgrade Reaction (Figure 2-25 to Figure 2-28). Therefore, the moments in Linear Contact Pressure and Modulus of Subgrade Reaction are similar.
- In Linear Contact Pressure, there is no interaction between the soil and the raft or the piles. Therefore, the settlements cannot be estimated by this method.

2.8.5.2 Modulus of Subgrade Reaction

- Modulus of Subgrade Reaction gives the smallest settlements (Figure 2-4 to Figure 2-6 and Table 2-2). If one compares the computed settlement with the measured settlement, the result is a difference of 85% to 93%. This means that the results of the settlements obtained by Modulus of Subgrade Reaction are incorrect.
- The nonlinear analysis (*NPRH*, *NPRD*) gives larger settlements under all nodes of the raft than the linear analysis (*LPR*), as shown in Figure 2-4 to Figure 2-6.
- Modulus of Subgrade Reaction has the smallest contact pressures compared to the Modulus of Compressibility. The contact pressure is at the edges of the raft and gives the maximum value (Figure 2-16 to Figure 2-18).
- Pile loads are constant for all piles and have the same value according to both the linear *LPR* and the nonlinear (*NPRH*, *NPRD*) (Figure 2-26 to Figure 2-28).
- Bearing factors from the nonlinear analysis (*NPRH*, *NPRD*) are smaller than those from the linear analysis (*LPR*), as shown in Table 2-2.
- The difference between the bearing factor by the linear analysis and the nonlinear analysis for *NPRH* and for *NPRD* is small. In the nonlinear analysis, it is 0% for *NPRH* and 0.2% for *NPRD* as shown in Table 2-2.

2.8.5.3 *Modulus of Compressibility*

- Modulus of Compressibility for the elastic raft gives the settlements as contours in an oval shape (ellipse). The settlements increase from the outside to the inside. The maximum settlement is in the middle (Figure 2-7 to Figure 2-9).
- Modulus of Compressibility for the rigid raft gives a uniform settlement across the raft (Figure 2-10 to Figure 2-12). Figure 2-12 shows a negative settlement in the non-linear analysis (*NPRD*). There is no convergence in the solution when using this method.
- The settlements of the nonlinear analyses (*NPRH*, *NPRD*) are larger than the settlements of the linear analysis (*LPR*).
- The contact pressures obtained by Modulus of Compressibility for the elastic raft are located at the edges of the raft and increase from the corners to the middle of the edges (Figure 2-19 to Figure 2-21). The *NPRH* method gives the maximum contact pressure.
- The contact pressures obtained by Modulus of Compressibility for the rigid raft are at the edges of the raft. The contact pressures by *LPR* and *NPRH* increase from the middle of the edges to the corners. The maximum contact pressure at the corners. *NPRD* gives the maximum contact pressures in the middle of the longest edge of the raft. A sign change takes place at the same edge. Therefore, negative base pressures result at the remaining edges including corners. (Figure 2-22 to Figure 2-24).
- The contact pressures obtained by Modulus of Compressibility for the rigid pile group are zero due to the lack of contact area between the raft and the subsoil.
- The largest pile loads obtained by Modulus of Compressibility for the elastic raft are in the central area of the raft (Figure 2-29 to Figure 2-31).
- The largest pile loads obtained by Modulus of Compressibility for the rigid raft are at the edges and corners for *LPR*, *NPRH*, where for *NPRD* there is a sign change in the pile loads along the longest edge. The largest and positive pile loads are distributed in the middle over the entire width (Figure 2-32 to Figure 2-34).
- The pile loads obtained by Modulus of Compressibility for the rigid pile group increase from the center of the raft to the edges and corners. The maximum pile loads are at the edges and corners of the raft (Figure 2-35 to Figure 2-37).
- Bearing factors from the nonlinear analysis (*NPRH*, *NPRD*) are generally smaller than those from the linear analysis (*LPR*).

In general, the following can be seen from the results of the various calculation methods:

- The settlements by nonlinear analyses (*NPRH*, *NPRD*) are greater under all nodes of the raft than those by the linear analyses (*LPR*), Table 2-2.
- Bearing factors are between 93% and 100% (Table 2-2).
- The pile reaction is almost 100%. In a piled raft, both elements (pile, raft) work together.
- The system for the rigid pile group is therefore governing.

2.8.6 Conclusions

Due to the small distance between the individual piles, the system is considered without a contact area and thus without the interaction between raft-soil and raft-piles. Consequently, results of the piled raft are similar to those of pile groups. Therefore, the calculation of the system as pile groups is suitable. Results of the settlements obtained by Modulus of Compressibility for the elastic raft, the rigid raft and the rigid pile groups are acceptable.

Modulus of Compressibility for the rigid pile groups is governing. A settlement of 3.3 [cm] was measured. According to Modulus of Compressibility for rigid pile groups using DIN 4014 (*NPRD*) one obtains 2.95 [cm] and using the hyperbolic function (*NPRH*) one obtains 2.18 [cm]. Modulus of Subgrade Reaction gives unrealistic values.

2.8.7 Recommendations

Table 2-3 shows the recommended calculation methods for pile groups of *Dashwood Houses* and similar foundation systems. As a result of the comparative calculations, it is recommended to be on the safe side to select the type of calculation method for the piled raft or pile groups according to the list in Table 2-3. One can use these methods for similar piled raft or pile groups lying on clay layers as in Frankfurt and London. In the tables, the calculation method is considered acceptable if the difference between the measured settlement and the computed settlement is less than 20%.

Table 2-3 Case study 1: Pile groups of *Dashwood Tower* in London

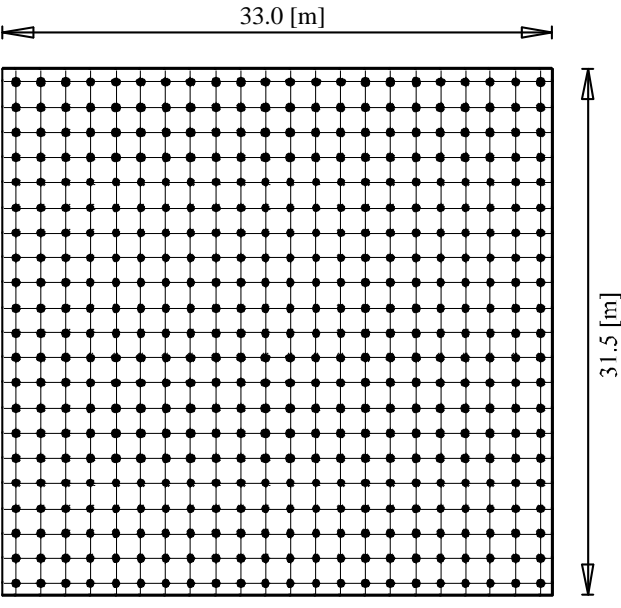
			
Description of the case:			
Height	= 61		
Number of floors	= 14		
Foundation area	= 33 [m] × 31.5 [m]		
Raft thickness	= 0.9 [m]		
Load	= 264 [kN/m ²]		
Number of piles	= 462		
Pile length	= 15 [m]		
Pile diameter	= 0.489 [m]		
Pile spacing	= 1.5 [m]		
Recommended calculation methods	Computed settlement [cm]	Measured settlement [cm]	Difference [%]
Modulus of Compressibility for rigid piled raft - <i>NPRD</i>	3.41		3
Modulus of Compressibility for rigid piled raft - <i>NPRH</i>	3.84		16
Modulus of Compressibility for pile groups - <i>LPR</i>	3.23	3.3	2
Modulus of Compressibility for pile groups - <i>NPRH</i>	3.46		5
Modulus of Compressibility for pile groups - <i>NPRD</i>	2.95		11

2.9 References

- [1] *Abate, S.* (2009): Analysis and Parametric Study of Piled Raft Foundation Using Finite Element Based Software.
Msc thesis, Addis Ababa University.
- [2] *Amann, P./ Breth, H./ Stroh, D.* (1975): Verformungsverhalten des Baugrundes beim Baugrubenaushub und anschließendem Hochhausbau am Beispiel des Frankfurter Ton
Mitteilungen der Versuchsanstalt für Bodenmechanik und Grundbau der Technischen Hochschule Darmstadt, Heft 15.
- [3] *Cecilia, B.* (2015): Serviceability and safety in the design of rigid inclusions and combined pile-raft foundations.
PhD thesis, Technical University Darmstadt.
- [4] *Clancy, P. & Randolph, M.* (1993): An approximate analysis procedure for piled raft foundations.
Int. J. Numer. Anal. Methods Geomech. 17, 849–869.
- [5] *Chaudhary, K.* (2010): Reconsiders for soil-structure interaction problems with significant material stiffness contrast.
PhD thesis, National University of Singapore.
- [6] DIN 4014: Bohrpfähle Herstellung, Bemessung und Tragverhalten
Ausgabe März 1990
- [7] *EA-Pfähle* (2007): Empfehlungen des Arbeitskreises "Pfähle" EA-Pfähle; Arbeitskreis Pfähle (AK 2,1) der Deutschen Gesellschaft für Geotechnik e.V., 1. Auflage, Ernst & Sohn, Berlin.
- [8] *Franke, E., Lutz, B. & El-Mossallamy, Y.* (1994): Measurements and numerical modelling of high rise building foundations on Frankfurt Clay. Proceedings of a conference on vertical and horizontal deformations of foundations and embankments.
ASCE Geotechnical Special Publication No. 40, Vol. 2, pp. 1325–1336.
- [9] *Franke, E., Lutz, B.* (1994): Pfahl-Platten-Gründungs-Messungen..
Report for the German Research Council (DFG) No. Fr60-1/11.
- [10] *El Gendy, M./ Hanisch, J./ Kany, M.* (2006): Empirische nichtlineare Berechnung von Kombinierten Pfahl-Plattengründungen
Bautechnik 9/06
- [11] *El Gendy, M.* (2007): Formulation of a composed coefficient technique for analyzing large piled raft.
Scientific Bulletin, Faculty of Engineering, Ain Shams University, Cairo, Egypt. Vol. 42, No. 1, March 2007, pp. 29-56
- [12] *El Gendy, M./ El Gendy, A.* (2018): Analysis of raft and piled raft by Program *ELPLA* GEOTEC Software Inc., Calgary AB, Canada.
- [13] *Lutz, B. / Wittmann, P. / El Mossallamy, Y./ Katzenbach, R.* (1996): Die Anwendung von Pfahl-Plattengründungen: Entwurfspraxis, Dimensionierung und Erfahrungen mit Gründungen in überkonsolidierten Tonen auf der Grundlage von Messungen.
Vorträge der Baugrundtagung 1996 in Berlin, pp. 153–164. Essen: DGGT.
- [14] *Poulos, H./ Davis, E.* (1980): Pile Foundation Analysis and Design
John Wiley & Sons, Inc.
- [15] *Poulos, H.* (1991): Analysis of piled strip foundations.
Proceedings of the conference on computer methods and advances in geomechanics. pp. 183–191, Rotterdam: Balkema.

-
- [16] *Poulos, H.* (1994): An approximate numerical analysis of pile–raft interaction. *Int. J. Numer. Anal. Methods Geomech.* 18, 73–92.
- [17] *Poulos, H. G., Small, J. C., Ta, L. D., Sinha, J. & Chen, L.* (1997): Comparison of some methods for analysis of piled rafts.. *Proc. 14th Int. Conf. Soil Mech. Found. Engng, Hamburg 2*, 1119-1124.
- [18] *Poulos, H.* (2001): Piled raft foundations: design and applications. *Géotechnique* 51, No. 2, 95-113
- [19] *Randolph, M.* (1983): Design of piled raft foundations. *Proceedings of the international symposium on recent developments in laboratory and field tests and analysis of geotechnical problems, Bangkok*, pp. 525–537.
- [20] *Reul, O./ Randolph, M.* (2003): Piled rafts in overconsolidated clay: comparison of in situ measurements and numerical analyses *Géotechnique* 53, No. 3, 301-315
- [21] *Russo, G.* (1998): Numerical analysis of piled raft *Int. J. Numer. Anal. Meth. Geomech.*, 22, 477-493
- [22] *Small, J.* (2002): Soil-Structure interaction. *Australian Geomechanics Journal*.
- [23] *Sommer, H./ Katzenbach, R.* (1990): Last-Verformungsverhalten des Messeturmes Frankfurt/ Main *Vorträge der Baugrundtagung 1990 in Karlsruhe*, Seite 371-380
- [24] *Sinha, J.* (1996): Piled raft foundations subjected to swelling and shrinking soils. *PhD thesis, University of Sydney, Australia*.
- [25] *Ta, L./ Small, J.* (1996): Analysis of piled raft systems in layered soils. *Int. J. Numer. Anal. Methods Geomech.* 20, 57–72.
- [26] *Hattab, F* (2007):Vergleichende Untersuchungen numerischer Modelle für die Berechnung von Pfahlplattengründungen. *Diplomarbeit, Institut für Geotechnik, UNIVERSITÄT SIEGEN*.