

# Sheet Pile Wall by the Program *GEO Tools*

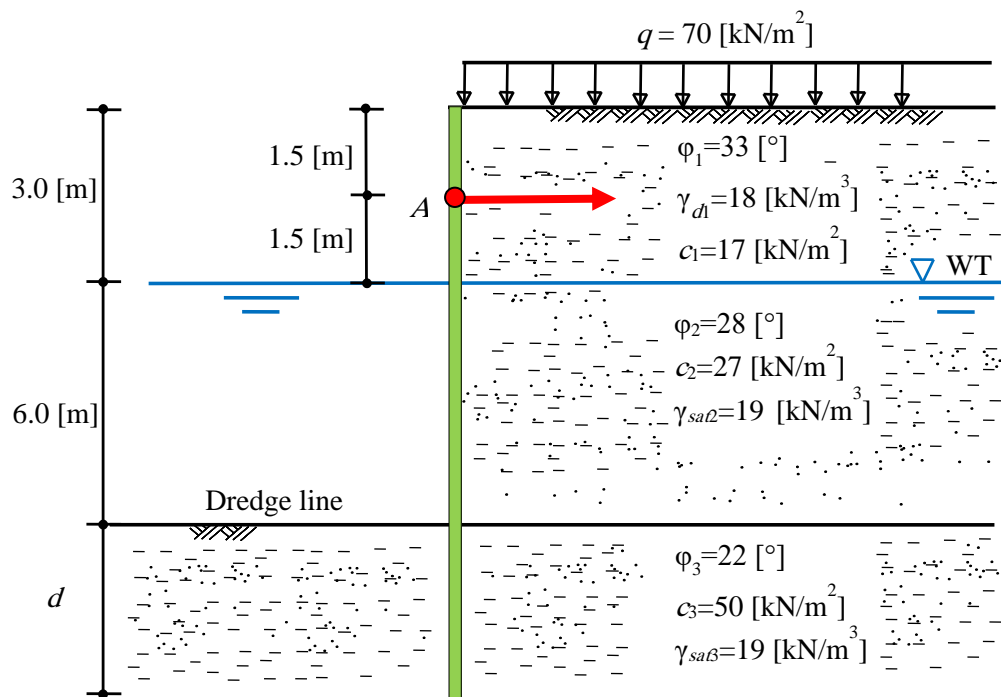

Mahmoud El Gendy  
Mohamed El Gendy

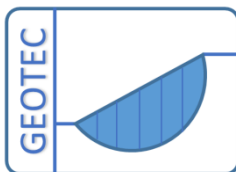

Copyright ©  
GEOTEC Software Inc.  
Canada  
Tele.: +1(587) 332-3323  
[geotec@geotecsoftware.com](mailto:geotec@geotecsoftware.com)  
[www.geotecsoftware.com](http://www.geotecsoftware.com)

Table of Contents	Page
<b>5 Sheet pile walls .....</b>	<b>5</b>
5.1 Introduction.....	5
5.2 Cantilever sheet pile wall.....	5
5.2.1 Penetration depth.....	5
5.2.2 Max. moment required to design the section .....	5
5.3 Anchored sheet pile wall.....	8
5.3.1 Anchored sheet pile wall with free earth support .....	8
5.3.2 Anchored sheet pile wall with fixed earth support .....	9
5.4 Defining the project data.....	12
5.4.1 Firm Header .....	12
5.4.2 Task of the program <i>GEO Tools</i> (Analysis Type) .....	12
5.4.3 Project Identification.....	14
5.4.4 Penetration depth for sheet pile wall.....	14
5.5 Examples to verify sheet pile wall .....	16
5.5.1 Introduction.....	16
5.5.2 Example 1: Cantilever sheet pile in sand with the absence of water table .....	16
5.5.3 Example 2: Cantilever sheet pile in sand with surcharge .....	25
5.5.4 Example 3: Cantilever sheet pile in sand with water table within the backfill ....	34
5.5.5 Example 4: Cantilever sheet pile penetrating in clay.....	44
5.5.6 Example 5: Cantilever sheet pile penetrating in $c$ - $\phi$ soil .....	55
5.5.7 Example 6: Design a cantilever sheet pile wall .....	65
5.5.8 Example 7: Anchored sheet pile penetrating in sand.....	76
5.5.9 Example 8: Sheet pile supported by a strut at the surface .....	88
5.5.10 Example 9: Anchored sheet pile penetrating in clay.....	98
5.5.11 Example 10: Anchored sheet pile penetrating $c$ - $\phi$ soil .....	110
5.5.12 Example 11: Anchored sheet pile penetrating in sand by EBM .....	122
5.5.13 Example 12: Anchored sheet pile in sand by <i>Blum's</i> method.....	135
5.6 References.....	142

## **Preface**

Various problems in Geotechnical Engineering can be investigated by the program *GEO Tools*. The original version of the program *GEO Tools* in the *ELPLA* package was developed by Prof. M. Kany, Prof. M. El Gendy, and Dr. A. El Gendy. After the death of Prof. Kany, Prof. M. El Gendy and Dr. A. El Gendy further developed the program to meet the needs of the practice.

This book describes the essential methods used in *GEO Tools* to analyze sheet pile walls with verification examples. *GEO Tools* is a simple user interface program and needs little information to define a problem.

There are four types of sheet piles available in *GEO Tools* depending on the depth of the excavation and the way the sheet pile is analyzed:

1. Cantilever sheet pile wall.
2. Anchored sheet pile wall with free earth support.
3. Anchored sheet pile wall with fixed earth support (Blum's method).
4. Anchored sheet pile wall with fixed earth support (Equivalent beam method).

Many test examples are presented to verify and illustrate the four types of sheet piles available in *GEO Tools*.

---

## 5 Sheet pile walls

### 5.1 Introduction

To build a structure with an underground floor, it is needed to construct a wall in the soil to retain a soil from other sides surrounding the structure. This wall is called a sheet pile. There are four types of sheet piles available in *GEO Tools* depending on the depth of the excavation and the way the sheet pile is analyzed:

1. Cantilever sheet pile wall.
2. Anchored sheet pile wall with free earth support.
3. Anchored sheet pile wall with fixed earth support (Blum's method).
4. Anchored sheet pile wall with fixed earth support (Equivalent beam method).

The next paragraphs describe the four types of sheet piles available in *GEO Tools* with some illustrated examples.

### 5.2 Cantilever sheet pile wall

A cantilever sheet pile wall is usually used when the retained height of the soil is relatively small, in which the depth of the free part is less than 5 [m] measured above the dredge line. In such a wall, the sheet pile acts as a wide cantilever beam above the dredge line. Typical forces acting on the sheet pile wall are shown in Figure 5.1. In addition, Figure 5.2 shows the movement and rotation of the sheet pile wall due to the acting forces. Due to these forces, the wall is rotated around the point  $o$  generating active and passive earth pressures, as shown in indicated zones.

#### 5.2.1 Penetration depth

As the depth  $d$  under the rotation point  $o$  is small, the system of loading acting on the wall can be simplified to those shown in Figure 5.3. It is assumed that the net passive resistance below point  $o$  is represented by a concentrated force  $R$  acting at a point slightly below point  $o$ . Neglecting this small distance, the penetration depth of the sheet pile wall can be calculated by equating moments about the rotation point  $o$  to zero. This depth is then increased by 20% to allow for the simplification involved in the method. In the analysis, a factor of safety  $F_s$  must be applied to the passive resistance.

#### 5.2.2 Max. moment required to design the section

To calculate the maximum moment required to design the section, the point of zero shears is determined first. Then, the maximum moment can be determined at this point.

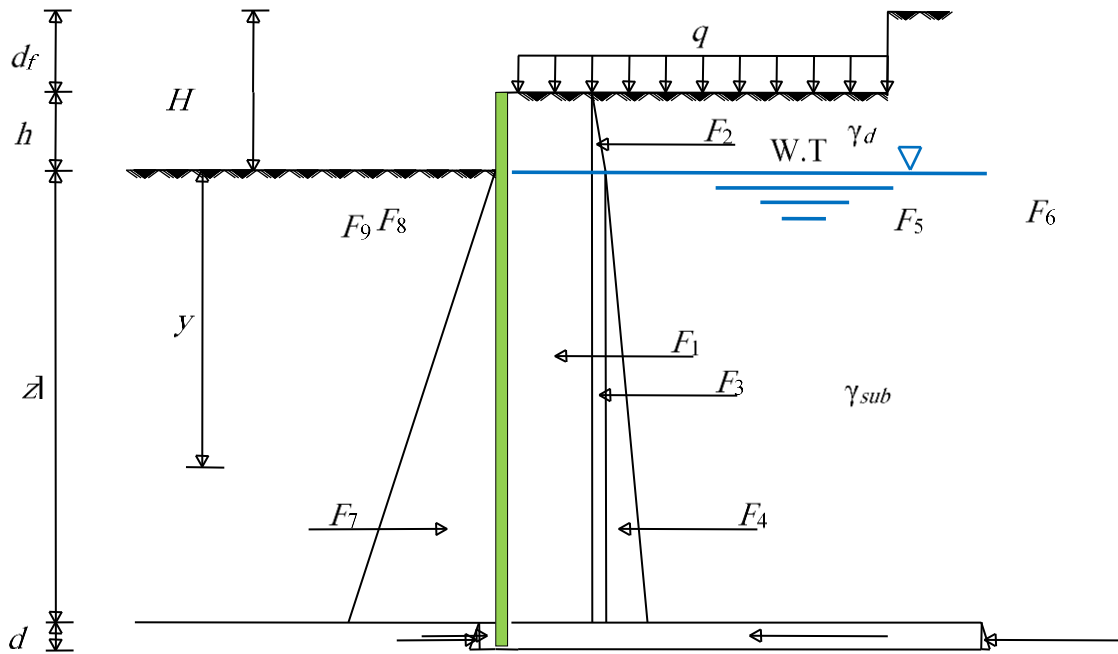

Figure 5.1 Distribution of earth pressure on pile wall

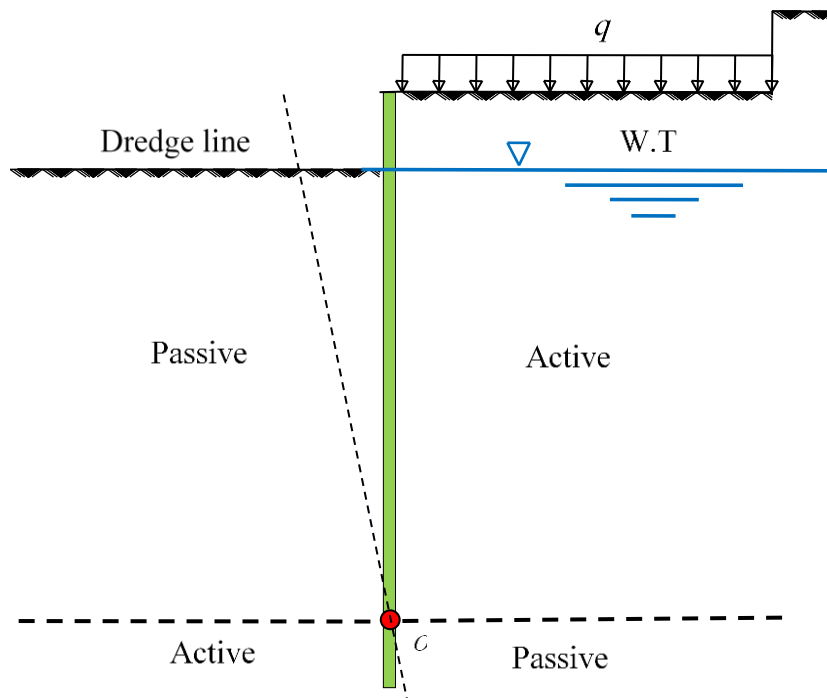

Figure 5.2 Movement and rotation of the sheet pile wall due to the acting forces

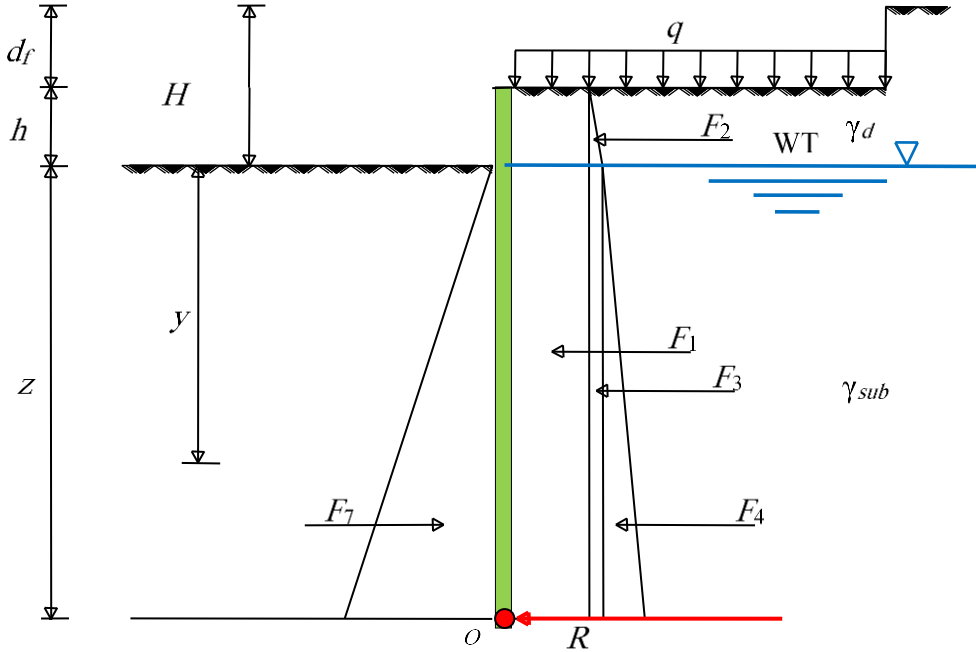

Figure 5.3 Simplification of forces acting on sheet pile wall

### 5.3 Anchored sheet pile wall

Anchored sheet pile wall is used when the retained height is deep and exceeds 5.0 [m]. In this case, the deflection on the sheet pile wall will be great, and thereby the depth of penetration and the section of sheet pile will be large to meet this large deflection. To reduce this deflection, the sheet pile should be supported from its upper edge (usually at a distance of 1.0 [m] to 2.0 [m] from the top). This support is called anchor, and the sheet pile with an anchor is called anchored sheet pile wall.

#### 5.3.1 Anchored sheet pile wall with free earth support

In an anchored sheet pile wall with free earth support, the soil is assumed as simple support at the end of the sheet pile, and the wall is simply supported from its upper edge by an anchor. Therefore, the deflection of the sheet pile will be similar to that of a simply supported beam, as shown in Figure 5.4. In this method, the bending moment of the sheet pile becomes zero at the end of the sheet pile.

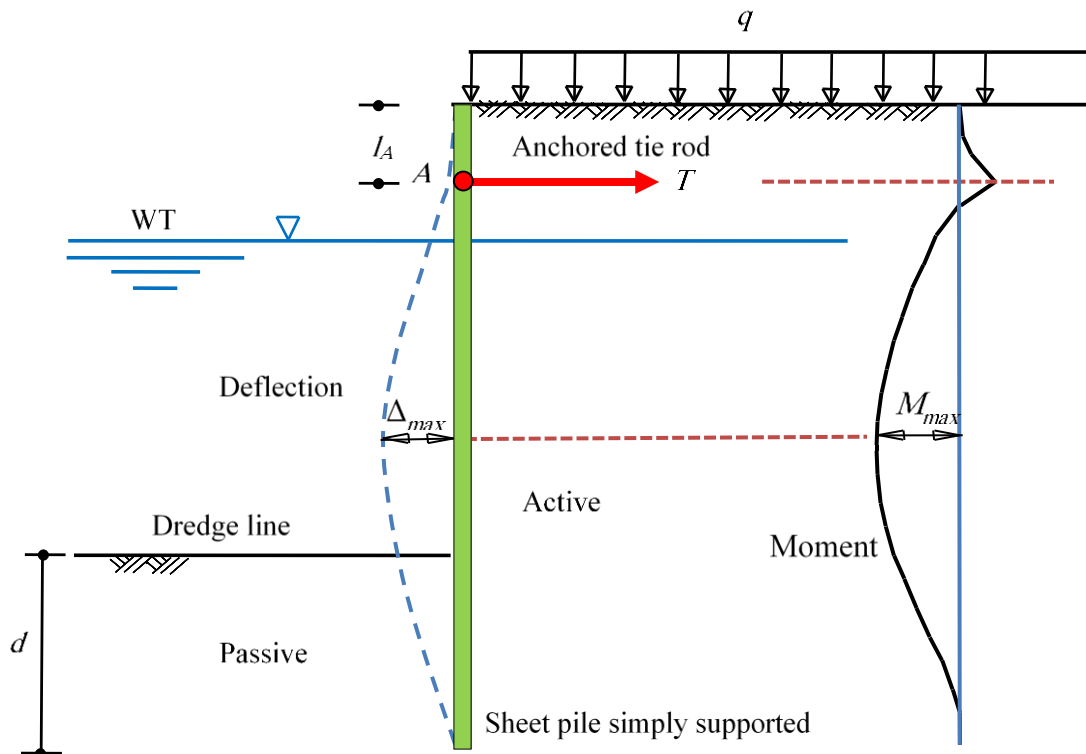

Figure 5.4 Anchored sheet pile wall with free earth support

### 5.3.2 Anchored sheet pile wall with fixed earth support

If the length of the sheet pile wall is slightly large, the moment and deflection of the sheet pile are expected to be of the form shown in Figure 5.5. Because of the extra length of the sheet pile wall, the toe will act as a fixed edge. The elastic line changes its curvature at the inflection point  $C$ .

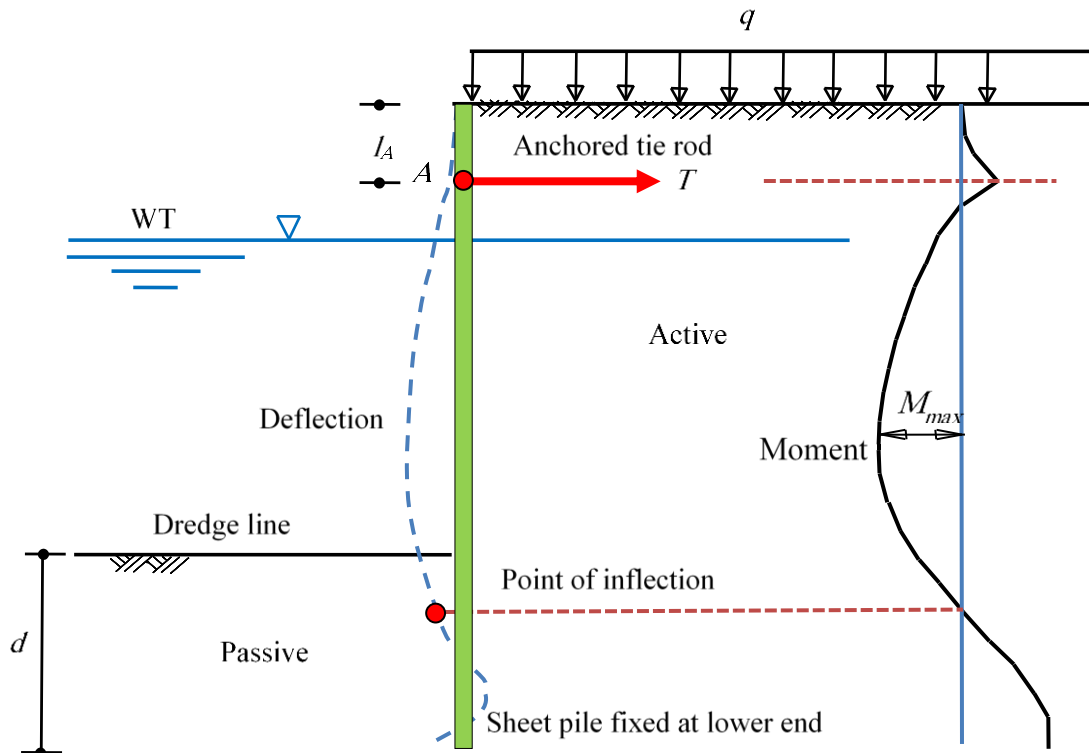

Figure 5.5 Anchored sheet pile wall with fixed earth support

#### 5.3.2.1 Anchored sheet pile wall with fixed earth support (Equivalent beam method)

As exact analysis of the anchored sheet pile with fixed earth support is complicated. An approximate method known as the equivalent beam method is generally used. The sheet pile is assumed to be a beam, which is simply supported at anchor point  $A$  and fixed at the lower end  $D$ .

The method assumes a hinge at the inflection point, where the bending moment is zero at the inflection point  $C$ . The part above the hinge can then be treated as a separate, freely supported beam with an overhanging end, as shown in Figure 5.6. Then the reactions  $R_C$ ,  $T$ , and bending moments can be determined from statics and simple beam theory. The lower portion below the inflection point can also be analyzed as a separate, freely supported beam on two supports,  $R_C$  and  $R_D$ .

In the method, the sheet pile in the sand may be analyzed by assuming the distance  $y$ , the position of inflection point from the dredge line, which is a function of the soil friction angle  $\phi$  below the dredge line, as given in Table 5.1.

Table 5.1 Relation between distance of the inflection point below dredged line and friction angle

$\phi$ [°]	20	25	30	35	40
$y$ [m]	$0.25h$	$0.15h$	$0.08h$	$0.03h$	$-0.006h$

Where  $h$  is the height of the sheet pile wall above the dredged level.



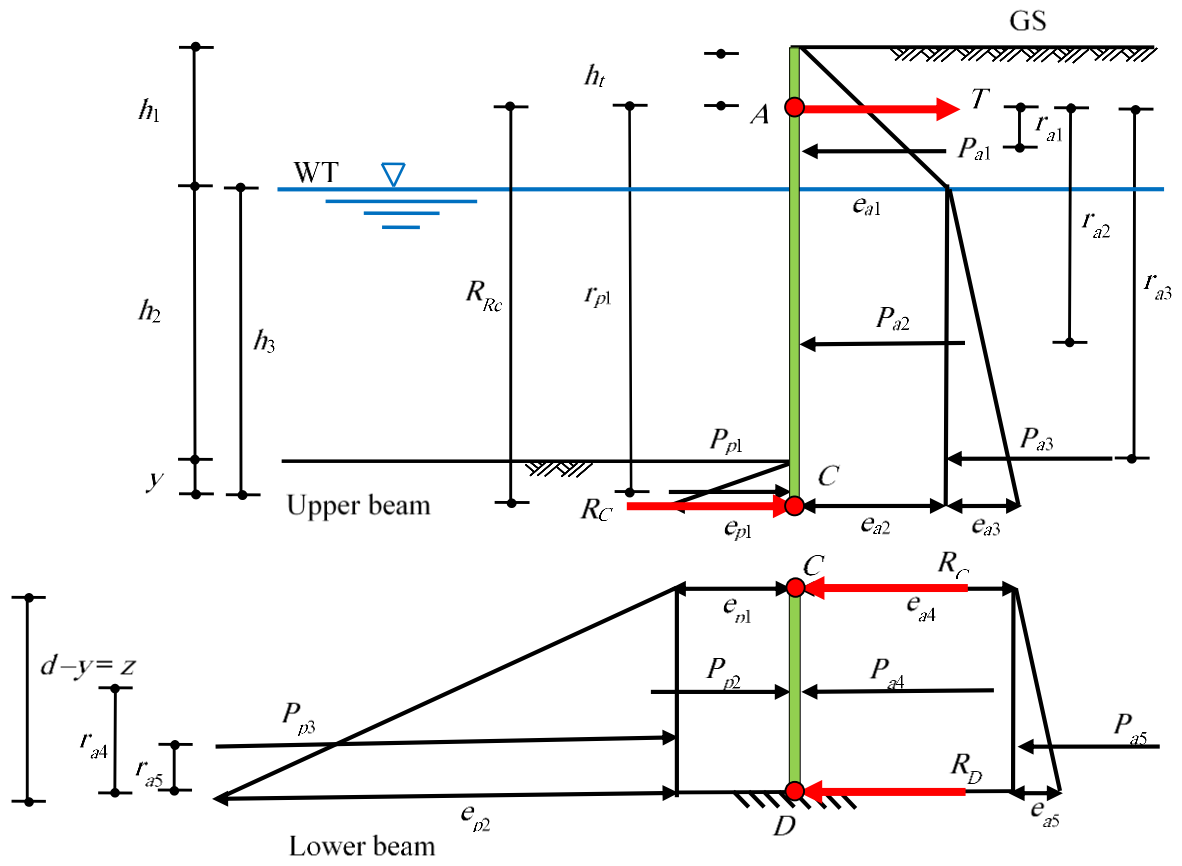

Figure 5.6 Equivalent beam method

### 5.3.2.2 Anchored sheet pile wall with fixed earth support (Blum's method)

Blum (1931) suggested that the loads and moment on the wall should be schematized, as shown in Figure 5.7.

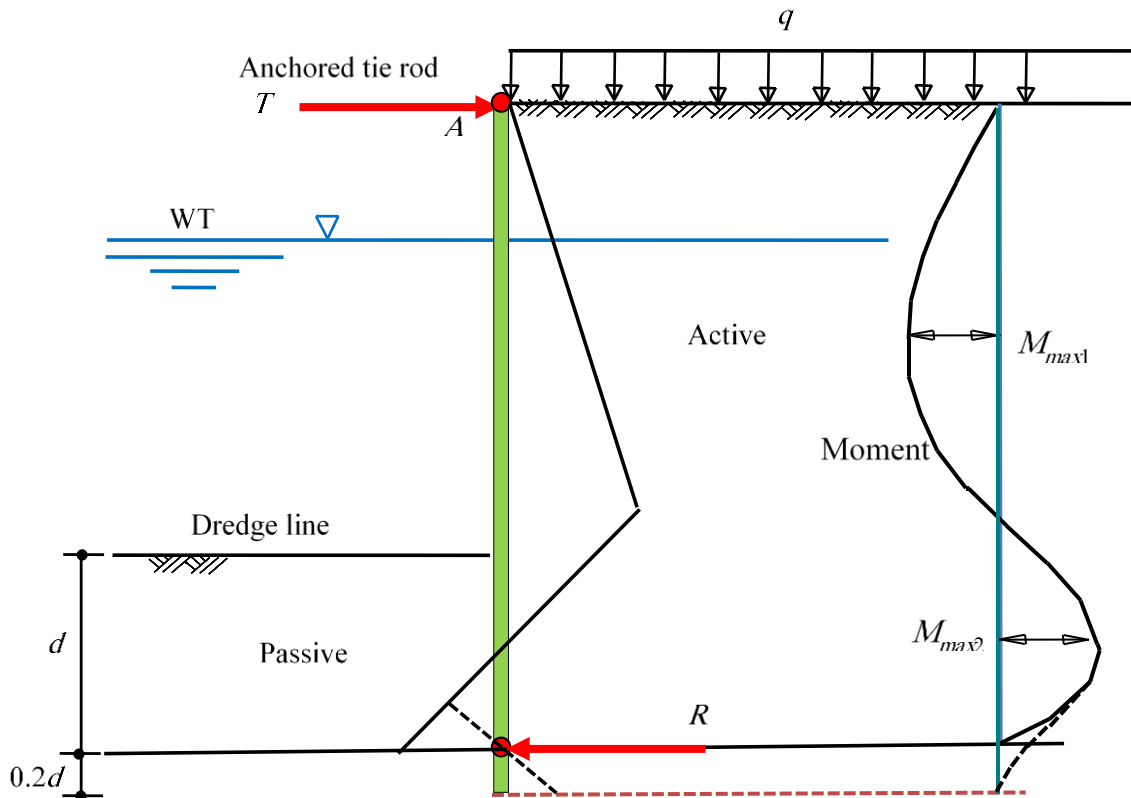

Figure 5.7 Anchored sheet pile according to Blum (1931)

The principle of Blum's method is that the sheet pile wall is considered fully clamped at its toe, with the additional condition that the bending moment at the toe is zero. Blum introduced the concept of an extra concentrated force  $R$  to account for the fixity of the sheet pile in the ground. This force is the result of the passive earth pressure increase generated by this fixity of the sheet pile. To generate this extra force  $R$ , the embedment depth  $d$  needs to be increased by 20%.

## 5.4 Defining the project data

### 5.4.1 Firm Header

When printing the results, the main data (firm name) are displayed on each page at the top in two lines. The firm name can be defined, modified and saved using the "Firm Header" option from the setting Tab (Figure 5.8).

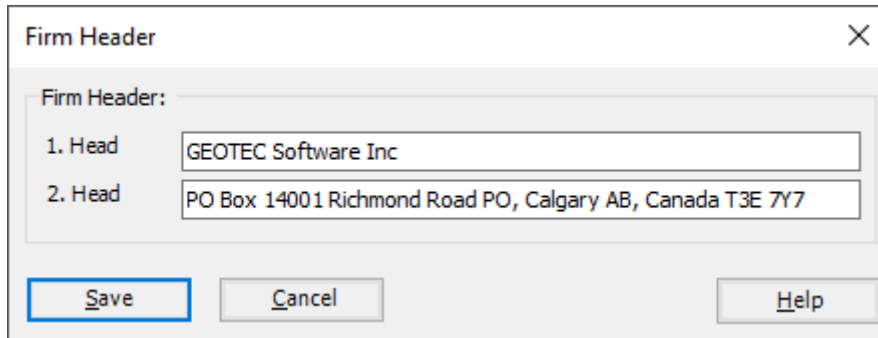

Figure 5.8 Firm Header

### 5.4.2 Task of the program *GEO Tools* (Analysis Type)

The program *GEO Tools* can be used to analyze various problems in Geotechnical Engineering for shallow foundations and deep foundations, Figure 5.9.

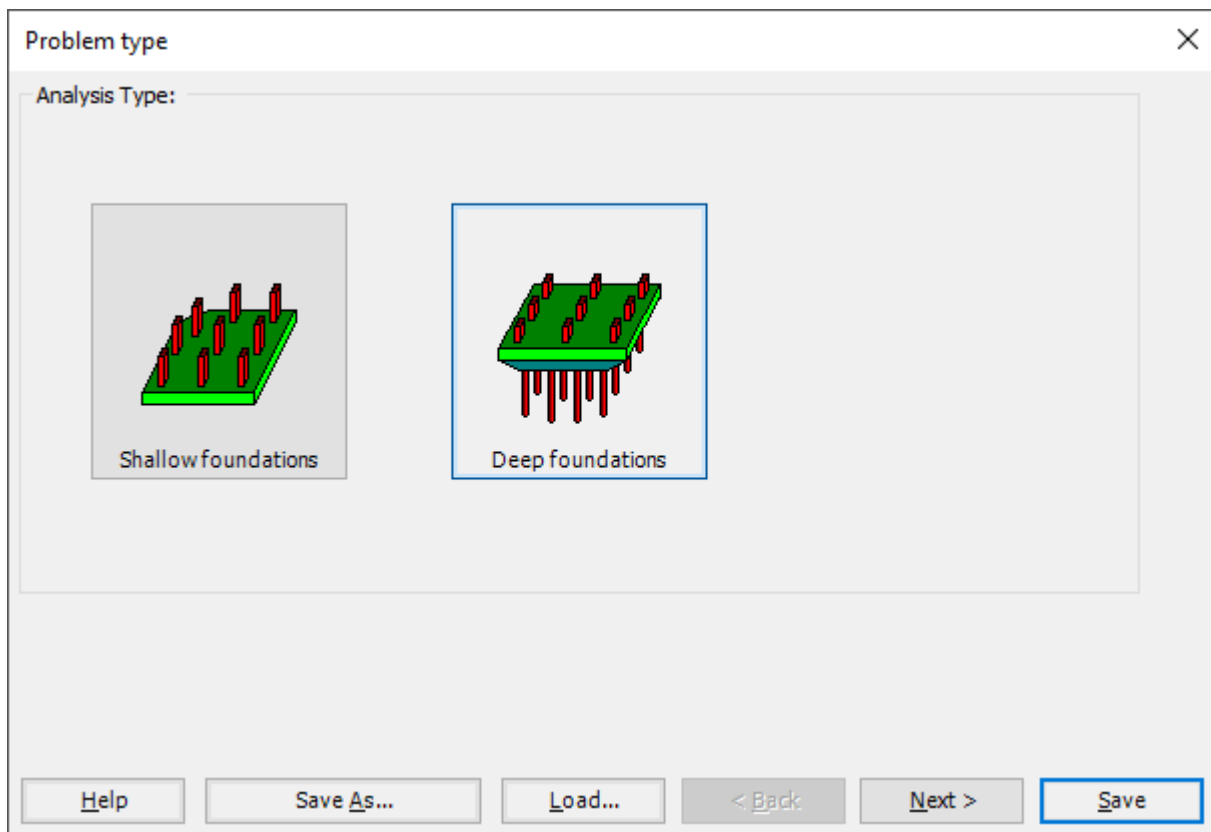

Figure 5.9 Problem type

According to the main menu (Figure 9.6), the following geotechnical problems can be calculated for deep foundations:

1. Analysis of single pile
2. Bearing capacity and settlement of single pile or pile wall
3. Analysis of piled raft
4. Stress coefficients according to GEDDES
5. Sheet pile wall
6. Analysis of single barrette
7. Analysis of a barrette raft
8. Lateral earth pressure
9. Effective vertical stress
10. Analysis of monopole

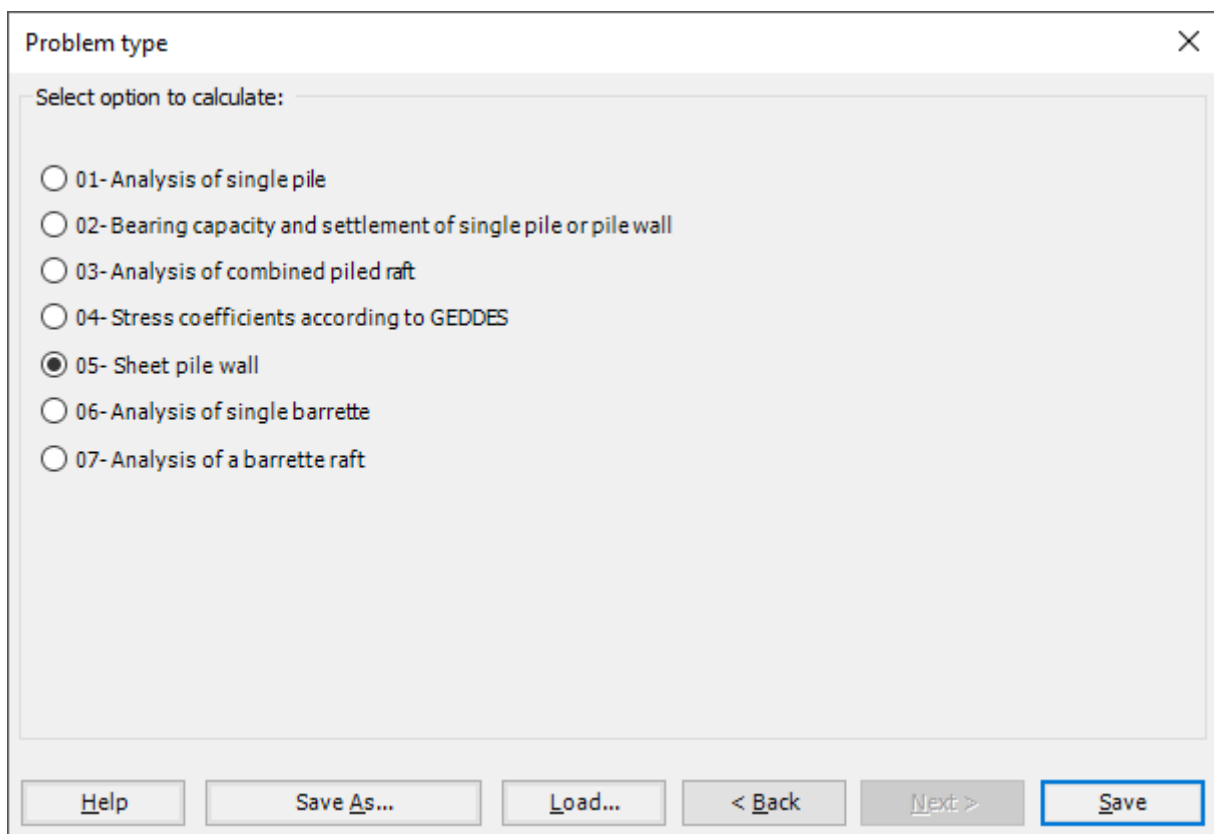

Figure 5.10 Problem type for deep foundation

In menu of Figure 5.10, select the option:

05- Sheet pile wall

The following paragraph describes how to determine the penetration depth for sheet pile walls by using the program *GEO Tools*. The input data are the uniform load intensity, water level under the ground surface, and properties of the soil layers.

### 5.4.3 Project Identification

In the program, it must be distinguished between the following two data groups:

- 1 System data (For identification of the project that is created and information to the output for the printer).
- 2 Soil data (Soil properties and so on).

The defining input data for these data groups is carried out as follows:

After clicking on the "Project Identification" option, the following general project data are defined (Figure 5.11):

Title: Title label  
 Date: Date  
 Project: Project label

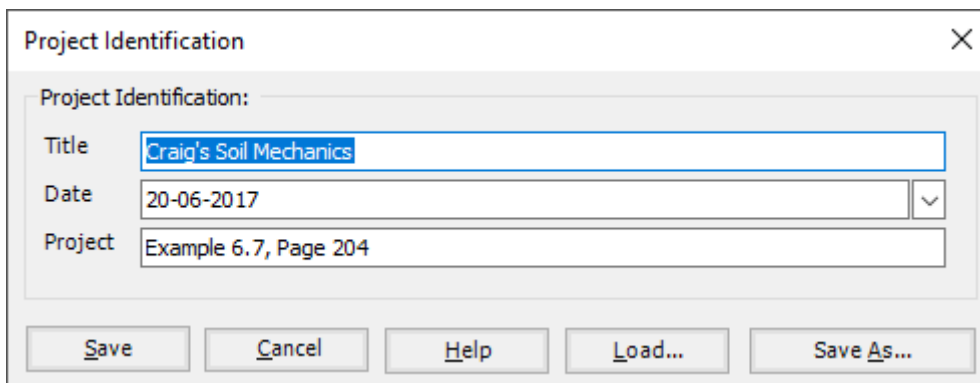

Figure 5.11 Project Identification

### 5.4.4 Penetration depth for sheet pile wall

After clicking on the "Sheet pile wall" option, the following data for determining penetration depth for sheet pile wall are defined (Figure 5.12):

Load intensity and water:

$q$  Distributed load [kN/m<sup>2</sup>]  
 $G_w$  Ground water depth left and right [m]  
 $F_s$  Safety factors for passive resistance and penetration depth [-]  
 $L_1$  Depth of the dredge line [m]  
 $d$  Anchor depth [m]

Soil data:

Layer:

$\gamma_d$  Dry unit weight of the soil left and right, [kN/m<sup>3</sup>]  
 $\gamma_{sat}$  Saturated unit weight of the soil left and right, [kN/m<sup>3</sup>]  
 $h$  Layer thickness [m]  
 $c$  Cohesion of the soil [kN/m<sup>2</sup>]  
 $\phi$  Angle of internal friction of the soil [°]

Sheet pile wall

Data | Soil Data

Select option to calculate:

- Cantilever sheet pile wall
- Anchored sheet pile wall with free earth support
- Anchored sheet pile wall with fixed earth support (Blum's method)
- Anchored sheet pile wall with fixed earth support (Equivalent beam method)

Data:

Distributed load	q	[kN/m <sup>2</sup> ]	10.0
Safety factor for passive resistance	Fs1	[-]	2.00
Safety factor for penetration depth	Fs2	[-]	1.20
Depth of dredge line	L1	[m]	2.50
Ground water depth-left	Gw_L	[m]	3.50
Ground water depth-right	Gw_R	[m]	3.50
Anchor depth	d	[m]	1.00

Results | Save | Load... | Ok | Save As... | Help | << Less

Figure 5.12 Sheet pile wall

## 5.5 Examples to verify sheet pile wall

### 5.5.1 Introduction

The application possibilities of the program *GEO Tools* to obtain the penetration depth for sheet pile walls are presented below in some numerical examples. The examples were carried out to verify and test the application of the proposed procedures outlined in this book.

### 5.5.2 Example 1: Cantilever sheet pile in sand with the absence of water table

#### 5.5.2.1 Description of the problem

To verify the analysis of the cantilever sheet pile in the sand, the penetration depth  $d$  for the given cantilever sheet pile in the sand in Figure 5.13 is obtained by hand calculation and compared with that obtained by *GEO Tools*. The unit weight of the sand is  $\gamma_d = 18$  [kN/m<sup>3</sup>], while the shear parameters are  $c = 0.0$  [kN/m<sup>2</sup>] and  $\phi = 30$  [°]. Take a factor of safety for the passive earth pressure  $F_s = 2.0$  [-] and a factor of safety for penetration depth = 20 %.

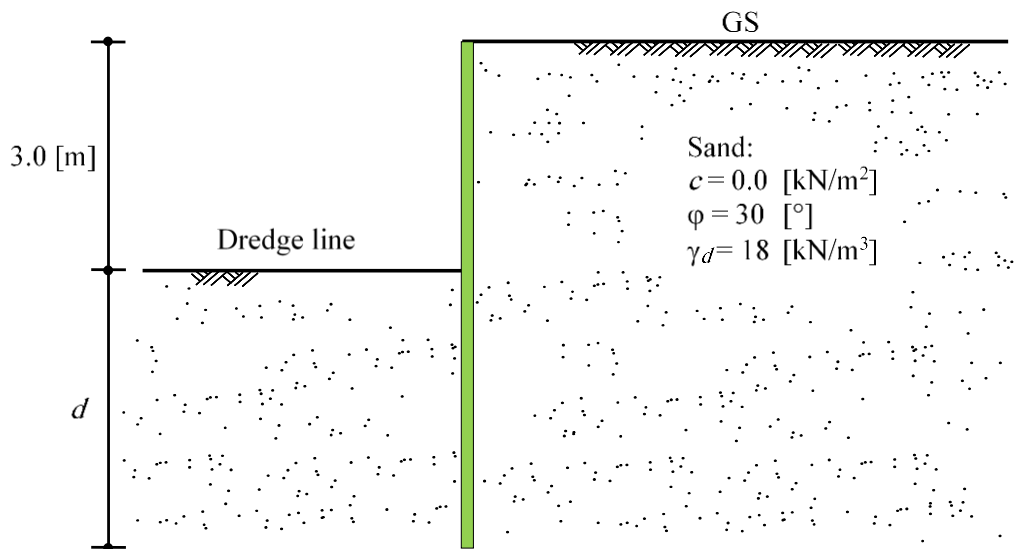

Figure 5.13 Cantilever sheet pile in sand

#### 5.5.2.2 Soil parameters and earth pressure coefficients

Dry unit weight of the soil	$\gamma_d$	= 18 [kN/m <sup>3</sup> ]
Angle of internal friction	$\phi$	= 30 [°]

Active earth pressure coefficient	$k_a$	= $(1 - \sin \phi) / (1 + \sin \phi) = 1/3$
-----------------------------------	-------	---

Passive earth pressure coefficient	$k_p$	= $(1 + \sin \phi) / (1 - \sin \phi) = 3$
------------------------------------	-------	---

$k_p / F_s = 1.5$

#### 5.5.2.3 Determining earth pressures, forces and moments on the wall

The earth pressure diagrams are shown in Figure 5.14. The procedure is to equate moments about  $o$ , the point of application of the force representing the net passive resistance below the rotation point. Earth pressures on the pile wall are listed in Table 5.2. Forces, arms, and moments are listed in Table 5.3. Passive earth pressure is divided by the specified factor of safety  $F_s$ .

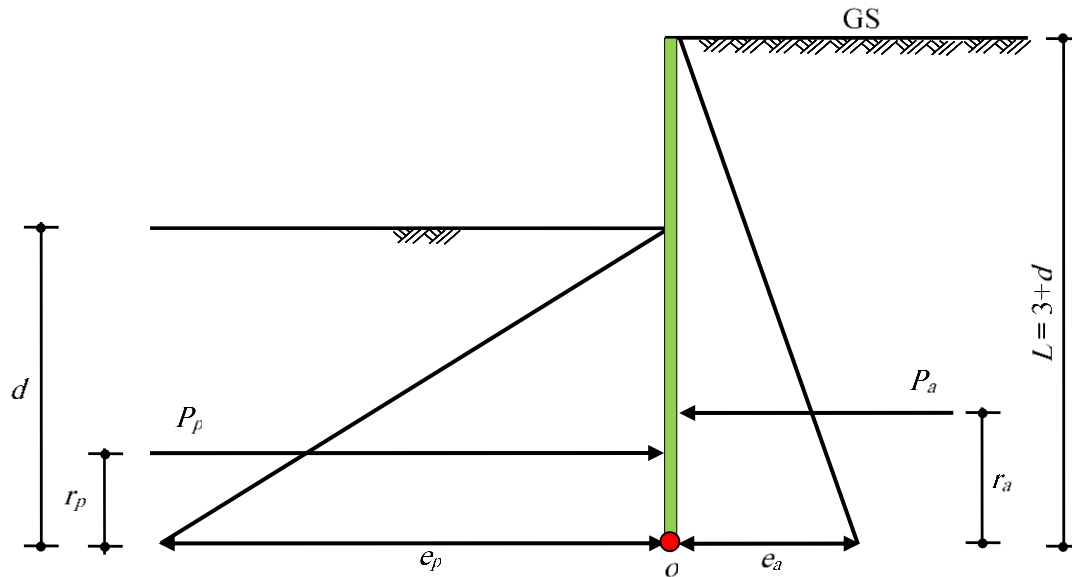

Figure 5.14 Earth pressures diagrams

Table 5.2 Earth pressures on the pile wall

Soil	Earth pressure $e$ [kN/m <sup>2</sup> ]		
Active	$e_a = \gamma_d (h + d) k_a$	$= 18 \times (3 + d) \times 0.33$	$= 18 + 6 d$
Passive	$e_p = \gamma_d d k_p / F_s$	$= 18 \times d \times 1.5$	$= 27 d$

Table 5.3 Earth forces on the pile wall and moments about point  $o$

Soil	Force $P$ [kN]		Arm $r$ [m]	Moment @ $o$ $M = P \times r$ [kN.m]
Active	$P_a =$	$0.5 e_1 (h + d) = 0.5 (18 + 6 d) (3 + d) = 3d^2 + 18 d + 27$	$(3 + d)/3$	$d^3 + 9d^2 + 27 d + 27$
Passive	$P_p =$	$0.5 e_2 d = 0.5 \times 27 d \times d = 13.5 d^2$	$d/3$	$4.5 d^3$

#### 5.5.2.4 Determining penetration depth and pile length

Equating active and passive moments about  $o$ ,  $M_a = M_p$

$$d^3 + 9 d^2 + 27 d + 27 = 4.5 d^3$$

or

$$3.5 d^3 - 9 d^2 - 27 d - 27 = 0$$

Solving the above equation gives:

$$d = 4.61 \text{ [m]}$$

Factor of safety for penetration depth = 20%. Therefore, the penetration depth with an additional 20% is:



Penetration depth  $d = 1.2 \times 4.61 = 5.53$  [m]

Pile wall length  $L = h + d = 3 + 5.53 = 8.53$  [m]

Figure 5.15 shows earth pressure diagrams in a single view.

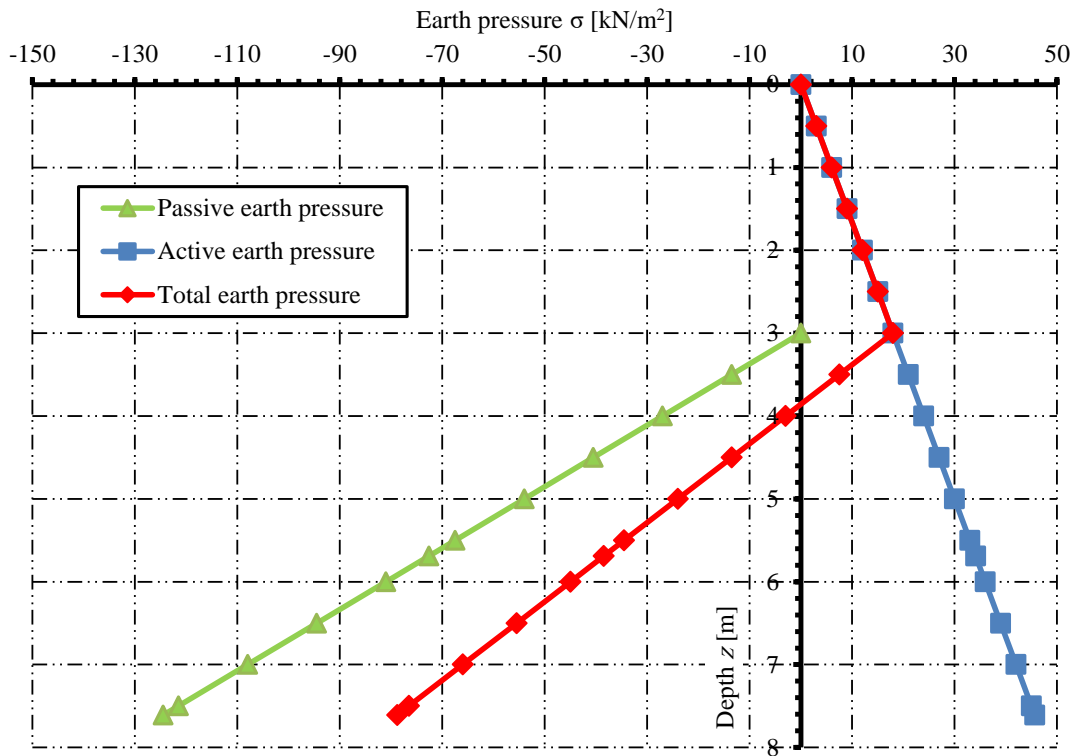

Figure 5.15 Earth pressures diagrams

### 5.5.2.5 Design of sheet pile wall

#### 5.5.2.5.1 Point of zero shear

Point of zero shears is determined from equating active and passive forces  $P_a(y) = P_p(y)$  at point  $s$  at distance  $y$  from the free surface of the dredge line, Figure 5.16.

$$0.5 \gamma_s (h + y) k_a (h + y) = 0.5 \gamma_s y k_p / 2 y$$

$$3 y^2 + 18 y + 27 = 13.5 y^2$$

or

$$10.5 y^2 - 18 y - 27 = 0$$

Solving the above equation, gives the point of zero shear at distance  $y$  as:

$$y = \frac{18 \pm \sqrt{18^2 + 4 \times 10.5 \times 27}}{2 \times 10.5} = 2.68 \text{ [m]}$$

Moment arm from the ground surface = 5.675 [m]

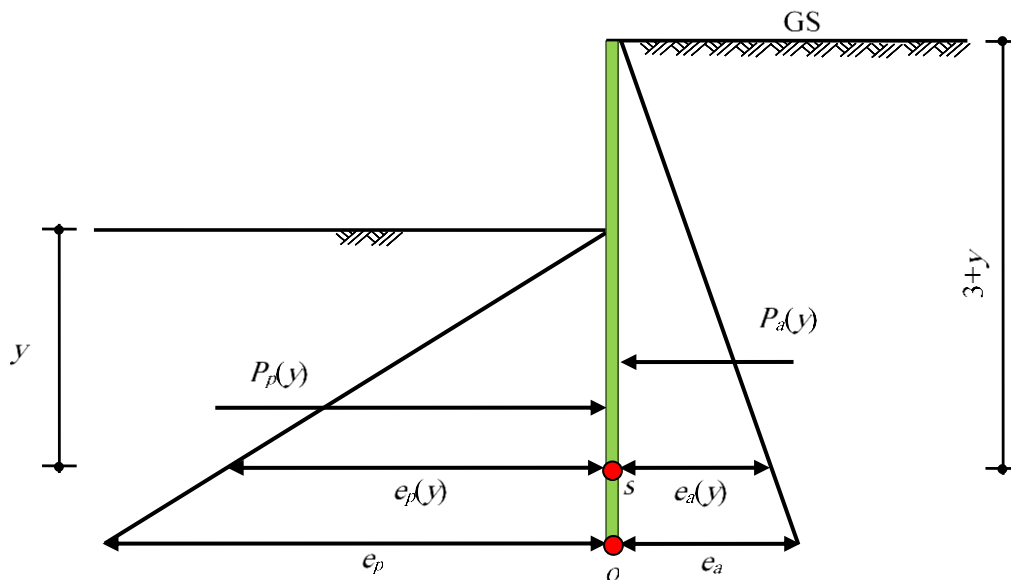

Figure 5.16 Point of zero shear

**5.5.2.5.2 Max. Moment**

The maximum moment at point *s* on the wall is calculated in Table 5.4.

Table 5.4 Determining maximum moment  $M_{max}$  at point *s*

Soil	Moment @ <i>s</i> $M = P \times y$ [kN.m]
Active	$M_a = y^3 + 9 y^2 + 27 y + 27 = 182.81$
Passive	$M_p = 4.5 y^3 = - 86.18$
	$M_{max} = M_a - M_p = 96.63$

**5.5.2.6 Penetration depth by GEO Tools**

The penetration depth obtained by *GEO Tools* for the cantilever sheet pile in the sand is equal to that obtained by hand calculation. The input data and results of *GEO Tools* for this example are presented on the next pages.

# Sheet Pile Wall

---

\*\*\*\*\*

GEO Tools  
Version 12.2

Program authors Prof. M. El Gendy/ Dr. A. El Gendy

\*\*\*\*\*

Title: Cantilever sheet pile in dry sand

Date: 03-11-2021

Project: Examples to verify sheet pile wall

File: Ex01 Cantilever in sand

-----  
Cantilever sheet pile wall  
-----

## Data:

Distributed load	q	[kN/m <sup>2</sup> ]	= 0.00
Safety factor for passive resistance	Fs1	[-]	= 2.00
Safety factor for penetration depth	Fs2	[-]	= 1.20
Depth of dredge line	L1	[m]	= 3.00

## Soil Data:

Ground water depth-left	Gwl_L	[m]	= 10.00
Ground water depth-right	Gwl_R	[m]	= 10.00

## Layer No.: 1

Cohesion of the soil	C	[kN/m <sup>2</sup> ]	= 0.000
Angle of internal friction	φ	[°]	= 30.00
Dry unit weight of the soil-left	γ <sub>d_L</sub>	[kN/m <sup>3</sup> ]	= 18.00
Saturated unit weight of the soil-left	γ <sub>sat_L</sub>	[kN/m <sup>3</sup> ]	= 18.00
Dry unit weight of the soil-right	γ <sub>d_R</sub>	[kN/m <sup>3</sup> ]	= 18.00
Saturated unit weight of the soil-right	γ <sub>sat_R</sub>	[kN/m <sup>3</sup> ]	= 18.00
Layer thickness	h	[m]	= 10.00

## Result:

Sheet pile length	L	[m]	= 8.53
Minimum sheet pile length	L <sub>m</sub>	[m]	= 7.61
Minimum penetration depth	L <sub>2</sub>	[m]	= 4.61
Resistance force at the toe	R	[kN]	= 113.2
Maximum moment	M <sub>max</sub>	[kN.m]	= 96.627
Moment arm from the ground surface	Y	[m]	= 5.69

Earth pressures on the sheet pile:

No.	Depth	Passive earth pressure from soil weight	Active earth pressure from soil weight	Earth pressure
I	z	ep	ea	E
[-]	[m]	[kN/m <sup>2</sup> ]	[kN/m <sup>2</sup> ]	[kN/m <sup>2</sup> ]
1	0.00	0.00	0.00	0.00
2	0.50	0.00	3.00	3.00
3	0.99	0.00	5.94	5.94
4	1.00	0.00	6.00	6.00
5	1.01	0.00	6.06	6.06
6	1.50	0.00	9.00	9.00
7	2.00	0.00	12.00	12.00
8	2.50	0.00	15.00	15.00
9	2.99	0.00	17.94	17.94
10	3.00	0.00	18.00	18.00
11	3.01	-0.27	18.06	17.79
12	3.50	-13.50	21.00	7.50
13	4.00	-27.00	24.00	-3.00
14	4.50	-40.50	27.00	-13.50
15	5.00	-54.00	30.00	-24.00
16	5.50	-67.50	33.00	-34.50
17	5.69	-72.63	34.14	-38.49
18	6.00	-81.00	36.00	-45.00
19	6.50	-94.50	39.00	-55.50
20	7.00	-108.00	42.00	-66.00
21	7.50	-121.50	45.00	-76.50
22	7.61	-124.47	45.66	-78.81

Shear Forces/ Moments:

No.	Depth	Shear force	Moment
I	z	Q	M
	[m]	[kN]	[kN.m]
1	0.00	0.00	0.00
2	0.50	-0.75	0.13
3	0.99	-2.94	0.97
4	1.00	-3.00	1.00
5	1.01	-3.06	1.03
6	1.50	-6.75	3.38
7	2.00	-12.00	8.00
8	2.50	-18.75	15.63
9	2.99	-26.82	26.73
10	3.00	-27.00	27.00
11	3.01	-27.18	27.27
12	3.50	-33.38	42.31
13	4.00	-34.50	59.50
14	4.50	-30.38	75.94
15	5.00	-21.00	89.00
16	5.50	-6.37	96.06
17	5.69	0.56	96.63
18	6.00	13.50	94.50
19	6.50	38.63	81.69
20	7.00	69.00	55.00
21	7.50	104.63	11.81
22	7.61	113.17	-0.16

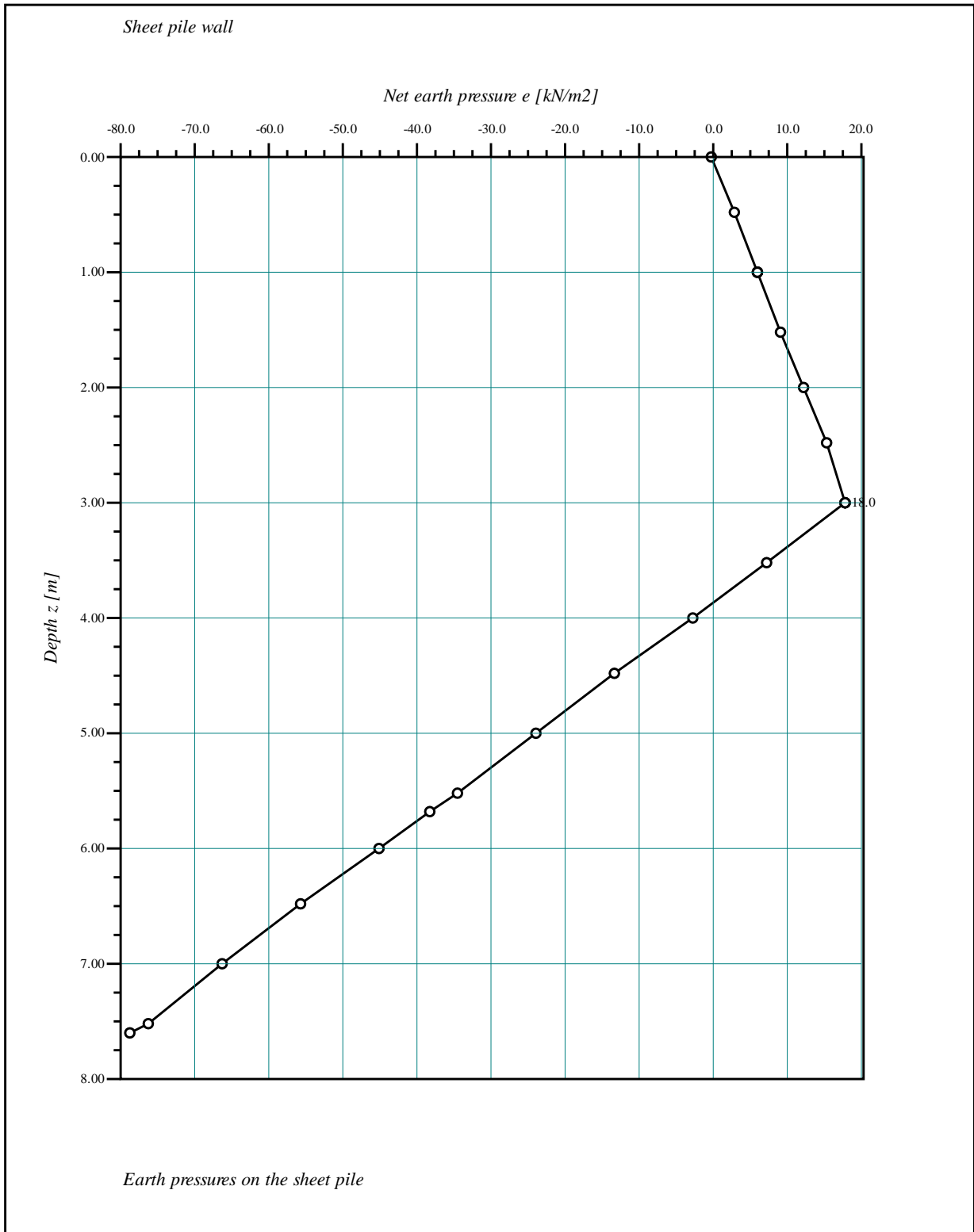

<p><b>GEOTEC Software Inc</b>                  PO Box 14001 Richmond Road PO, Calgary AB, Canada T3E 7Y7</p>	
<p>Scale: 623                  File: Ex01                  Page No.:</p>	<p>Project: Examples to verify sheet pile wall                  Date: 03-11-2021                  Title: Cantilever sheet pile in dry sand</p>

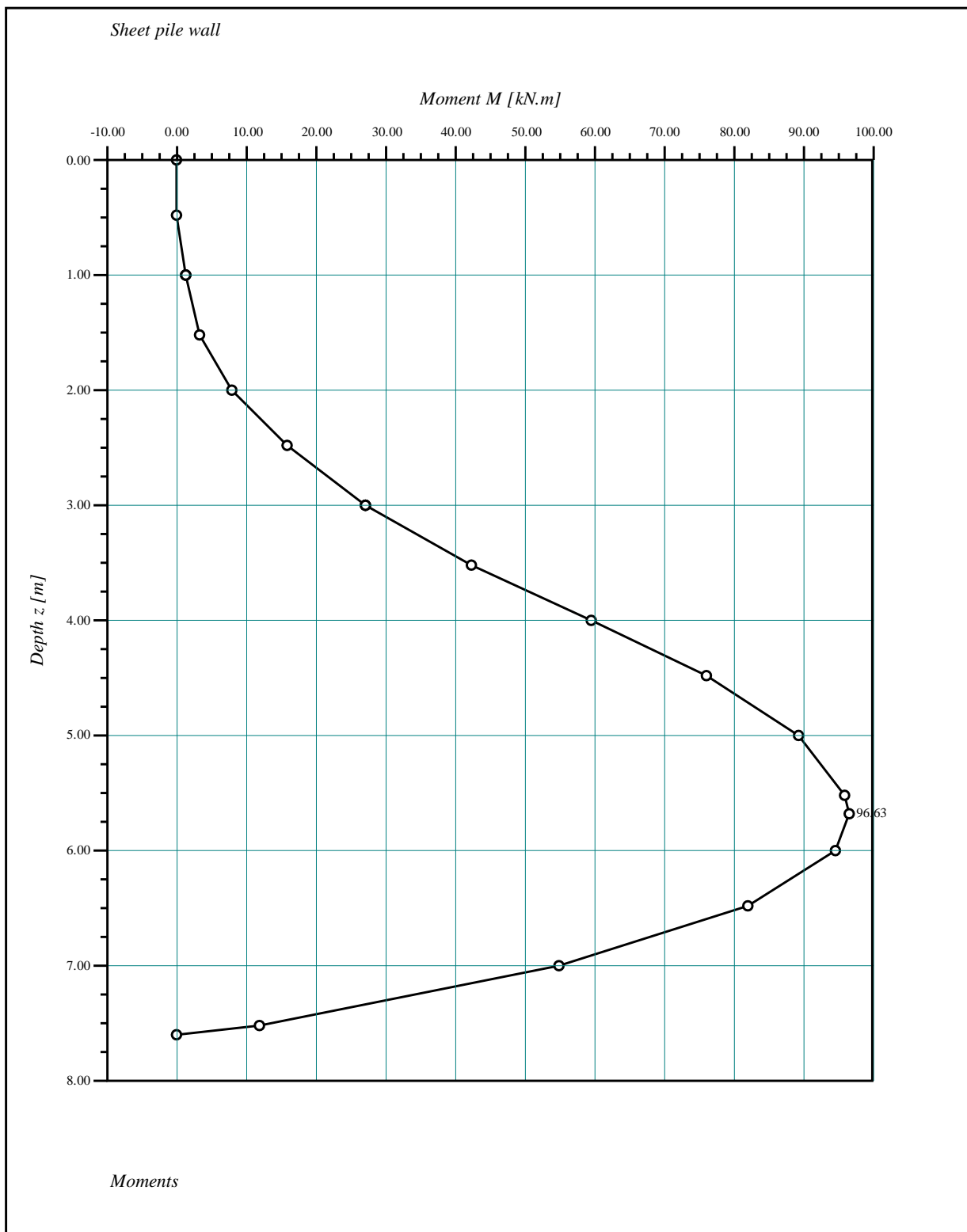

<p><b>GEOTEC Software Inc</b>                  PO Box 14001 Richmond Road PO, Calgary AB, Canada T3E 7Y7</p>	
<p><b>Scale:</b> 661  <b>File:</b> Ex01  <b>Page No.:</b></p>	<p><b>Project:</b> Examples to verify sheet pile wall  <b>Date:</b> 03-11-2021  <b>Title:</b> Cantilever sheet pile in dry sand</p>

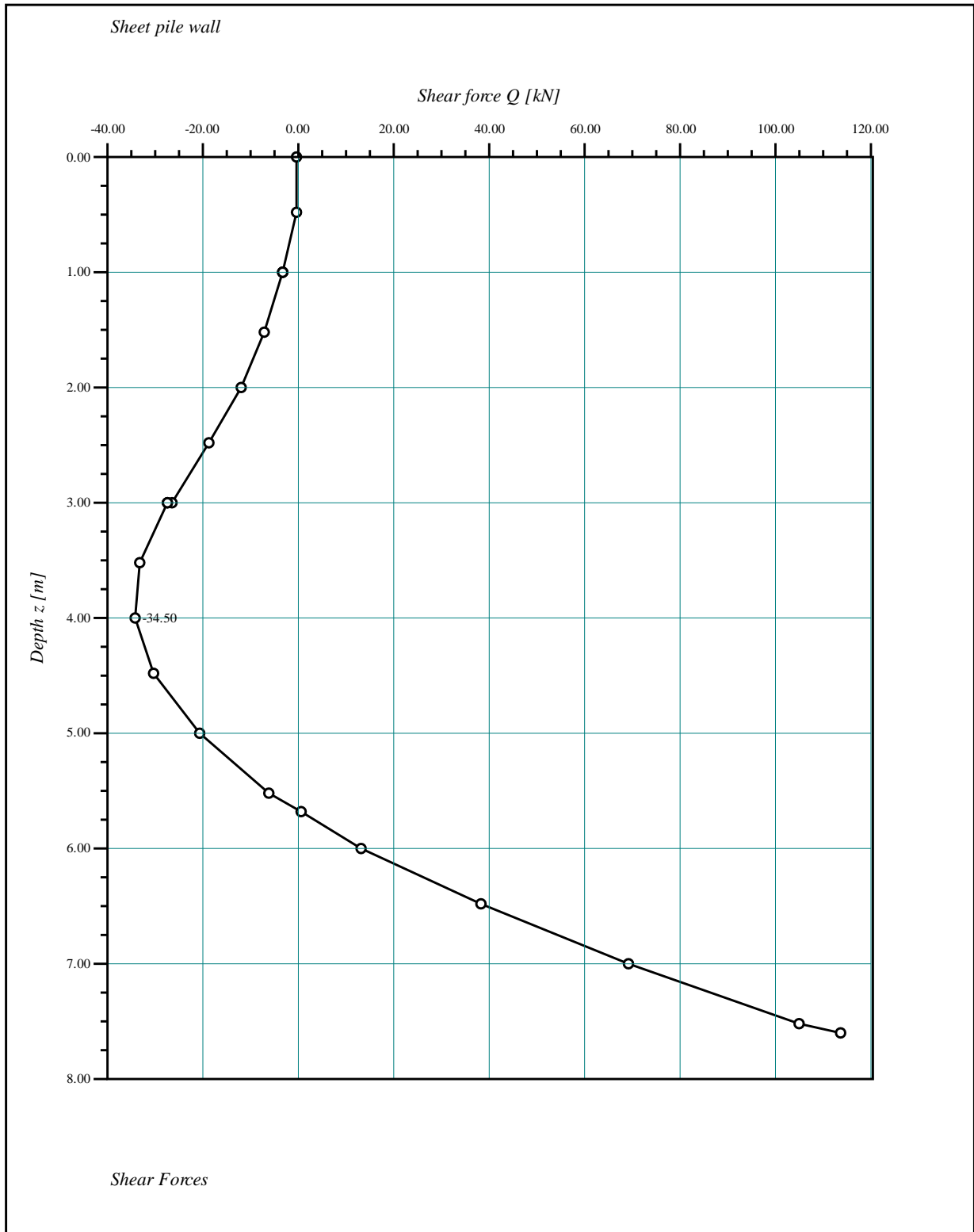

<p><b>GEOTEC Software Inc</b>                  PO Box 14001 Richmond Road PO, Calgary AB, Canada T3E 7Y7</p>	
<p><b>Scale: 966</b>  <b>File: Ex01</b>  <b>Page No.:</b></p>	<p><b>Project: Examples to verify sheet pile wall</b>  <b>Date: 03-11-2021</b>  <b>Title: Cantilever sheet pile in dry sand</b></p>

### 5.5.3 Example 2: Cantilever sheet pile in sand with surcharge

#### 5.5.3.1 Description of the problem

To verify the analysis of the cantilever sheet pile in the sand, the penetration depth  $d$  for the given cantilever sheet pile in the sand in Figure 5.17 is obtained by hand calculation and compared with that obtained by *GEO Tools*. The unit weight of the sand is  $\gamma_d = 18$  [kN/m<sup>3</sup>], while the shear parameters are  $c = 0.0$  [kN/m<sup>2</sup>] and  $\phi = 30$  [°]. A surcharge of  $q = 4.5$  [kN/m<sup>2</sup>] is applied on the surface. Take a factor of safety for the passive earth pressure  $F_s = 2.0$  [-].

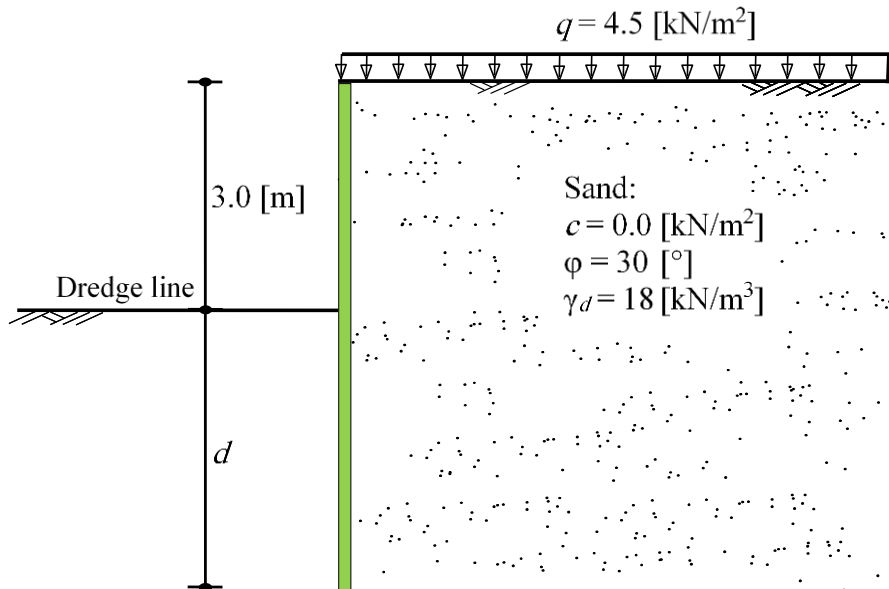

Figure 5.17 Cantilever sheet pile in sand

#### 5.5.3.2 Soil parameters and earth pressure coefficients

Dry unit weight of the soil  $\gamma_d = 18$  [kN/m<sup>3</sup>]  
 Angle of internal friction  $\phi = 30$  [°]

Active earth pressure coefficient  $k_a = (1 - \sin \phi) / (1 + \sin \phi) = 1/3$

Passive earth pressure coefficient  $k_p = (1 + \sin \phi) / (1 - \sin \phi) = 3$

$k_p / F_s = 1.5$

#### 5.5.3.3 Determining earth pressures, forces and moments on the wall

The earth pressure diagrams are shown in Figure 5.18. The procedure is to equate moments about  $o$ , the point of application of the force representing the net passive resistance below the rotation point. Earth pressures on the pile wall are listed in Table 5.5. Forces, arms, and moments are listed in Table 5.6. Passive earth pressure is divided by the specified factor of safety  $F_s$ .



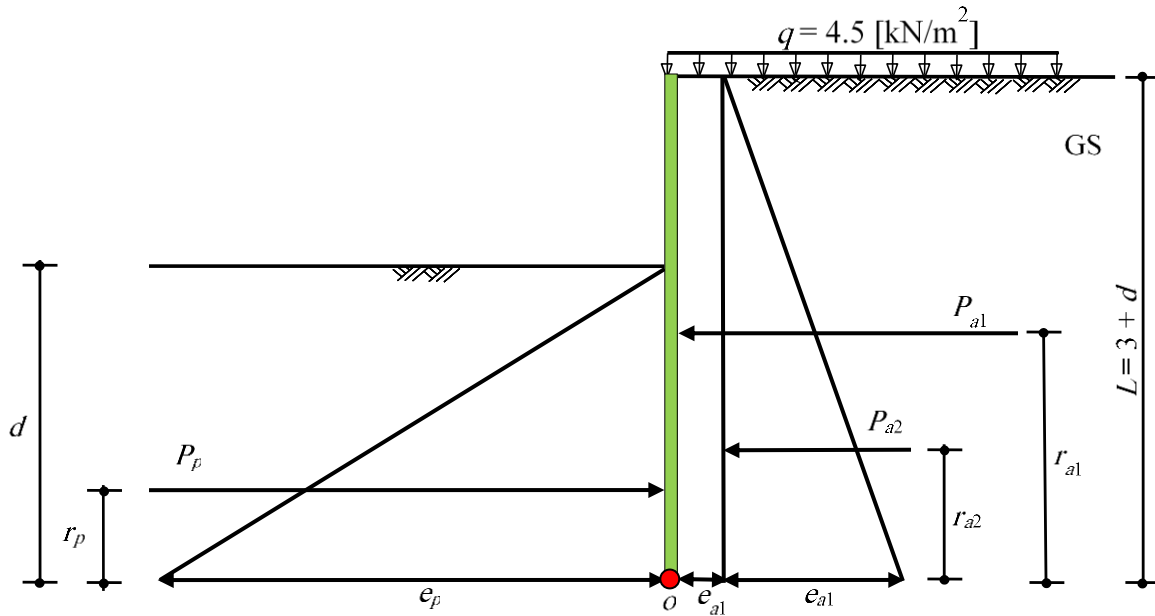

Figure 5.18 Earth pressures diagrams

Table 5.5 Earth pressures on the pile wall

Soil	Earth pressure $e$ [kN/m <sup>2</sup> ]		
Active	$e_{a1} = q k_a$	$= 4.5 \times 0.33$	$= 1.5$
	$e_{a2} = \gamma_d (h + d) k_a$	$= 18 \times (3 + d) \times 0.33$	$= 18 + 6d$
Passive	$e_p = \gamma_d d k_p / F_s$	$= 18 \times d \times 1.5$	$= 27d$

Table 5.6 Earth forces on the pile wall and moments about point o

Soil	Force $P$ [kN]		Arm $r$ [m]	Moment @ o $M = P \times r$ [kN.m]
Active	$P_{a1} =$	$e_{a1} (3 + d) = 4.5 + 1.5d$	$(3 + d) / 2$	$0.75d^2 + 4.5d + 6.75$
	$P_{a2} =$	$0.5 e_1 (h + d) =$ $0.5 (18 + 6d) (3 + d) = 3d^2 + 18d + 27$	$(3 + d) / 3$	$d^3 + 9d^2 + 27d + 27$
	$M_{at} = \Sigma M_a = d^3 + 9.75d^2 + 31.5d + 33.75$			
Passive	$P_p =$	$0.5 e_2 d = 0.5 \times 27d \times d = 13.5d^2$	$d/3$	$4.5d^3$

**5.5.3.4 Determining penetration depth and pile length**

Equating active and passive moments about o,  $M_{at} = M_p$

$$d^3 + 9.75d^2 + 31.5d + 33.75 = 4.5d^3$$

or

$$3.5 d^3 - 9.75 d^2 - 31.5 d - 33.75 = 0$$

Solving the above equation gives:

$$d = 4.98 \text{ [m]}$$

Factor of safety for penetration depth = 20%. Therefore, the penetration depth with an additional 20% is:

$$\text{Penetration depth } d = 1.2 \times 4.98 = 5.98 \text{ [m]}$$

$$\text{Pile wall length } L = h + d = 3 + 5.98 = 8.98 \text{ [m]}$$

Figure 5.19 shows earth pressure diagrams in a single view.

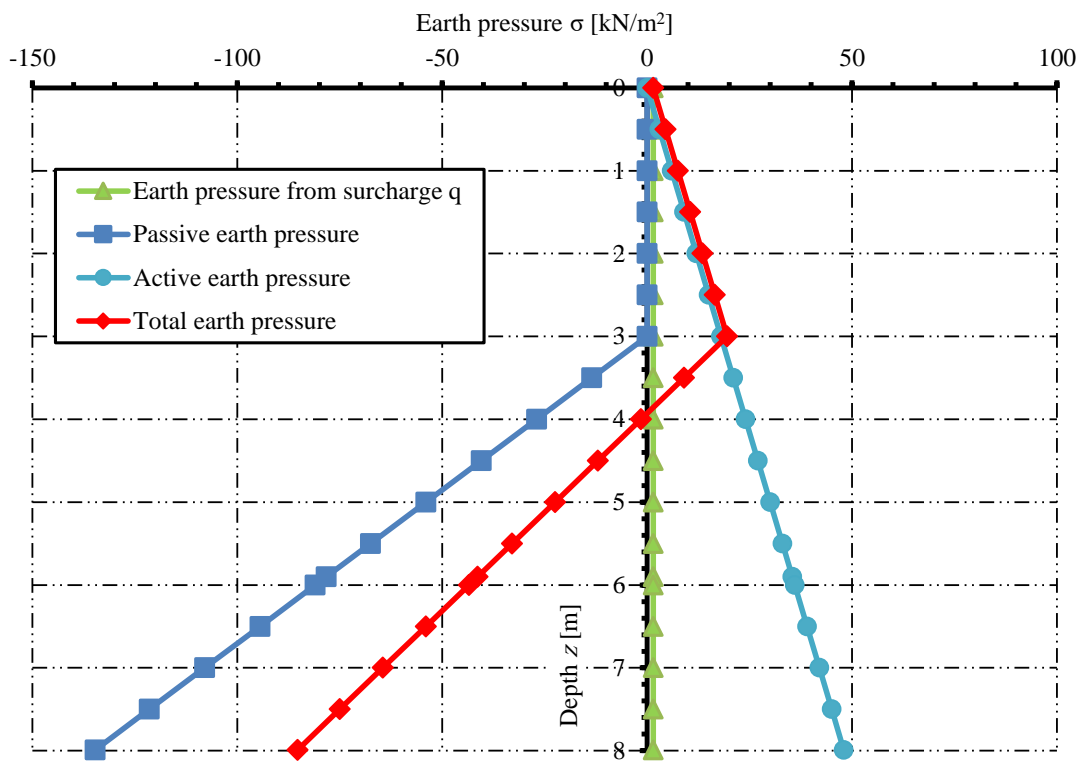

Figure 5.19 Earth pressures diagrams

### 5.5.3.5 Design of sheet pile wall

#### 5.5.3.5.1 Point of zero shear

Point of zero shears is determined from equating active and passive forces  $P_a(y) = P_p(y)$  at point  $s$  at distance  $y$  from the free surface of the dredge line, Figure 5.20.

$$q k_a (h + y) + 0.5 \gamma_s (h + y) k_a (h + y) = 0.5 \gamma_s y k_p / 2 y$$

$$3 y^2 + 19.5 y + 31.5 = 13.5 y^2$$

or

$$10.5 y^2 - 19.5 y - 31.5 = 0$$

Solving the above equation, gives the point of zero shear at distance  $y$  as:

$$y = \frac{19.5 \pm \sqrt{19.5^2 + 4 \times 10.5 \times 31.5}}{2 \times 10.5} = 2.89 \text{ [m]}$$

Moment arm from the ground surface = 5.89 [m]

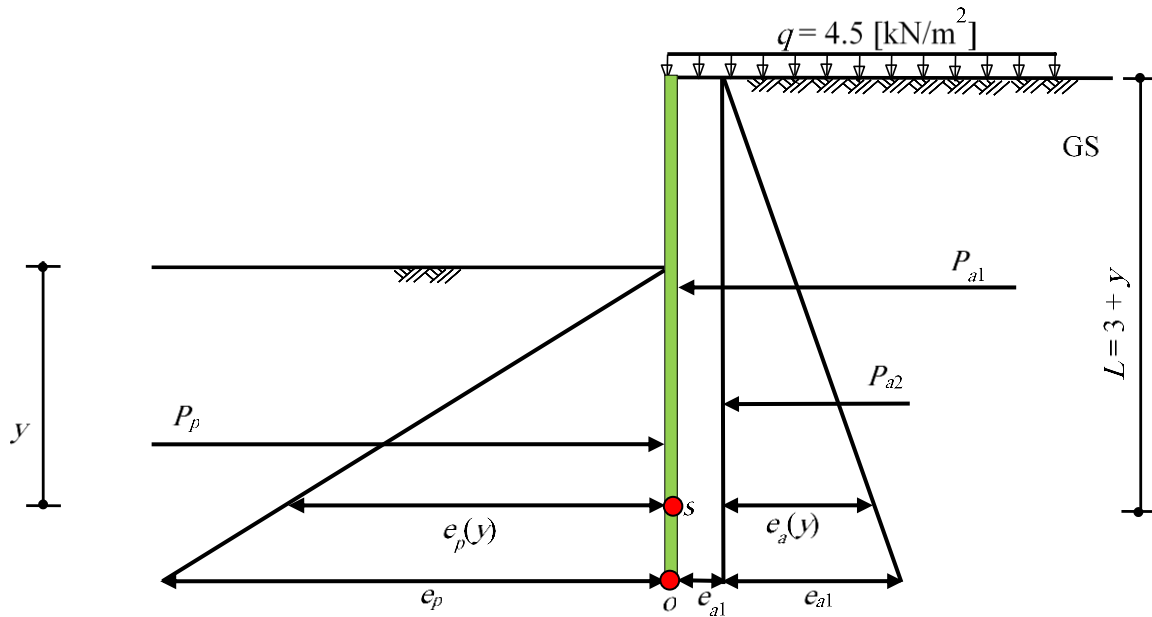

Figure 5.20 Point of zero shear

### 5.5.3.5.2 Max. Moment

The maximum moment at point  $s$  on the wall is calculated in Table 5.7.

Table 5.7 Determining maximum moment  $M_{max}$  at point  $s$

Soil	Moment @ $s$ $M = P \times y$ [kN.m]
Active	$M_a = y^3 + 9.75 y^2 + 31.5 y + 33.75 = 230.36$
Passive	$M_p = 4.5 y^3 = - 108.62$
	$M_{max} = M_a - M_p = 121.74$

### 5.5.3.6 Penetration depth by GEO Tools

The penetration depth obtained by *GEO Tools* for the cantilever sheet pile in sand is equal to that obtained by hand calculation. The input data and results of *GEO Tools* for this example are presented on the next pages.

\*\*\*\*\*

GEO Tools  
Version 12.2

Program authors Prof. M. El Gendy/ Dr. A. El Gendy

\*\*\*\*\*

Title: Cantilever in dry sand with surcharge

Date: 03-11-2021

Project: Examples to verify sheet pile wall

File: Ex02 Cantilever in sand with q

-----  
Cantilever sheet pile wall  
-----

## Data:

Distributed load	q	[kN/m <sup>2</sup> ]	= 4.50
Safety factor for passive resistance	Fs1	[-]	= 2.00
Safety factor for penetration depth	Fs2	[-]	= 1.20
Depth of dredge line	L1	[m]	= 3.00

## Soil Data:

Ground water depth-left	Gwl_L	[m]	= 10.00
Ground water depth-right	Gwl_R	[m]	= 10.00

## Layer No.: 1

Cohesion of the soil	C	[kN/m <sup>2</sup> ]	= 0.000
Angle of internal friction	φ	[°]	= 30.00
Dry unit weight of the soil-left	γ <sub>d_L</sub>	[kN/m <sup>3</sup> ]	= 18.00
Saturated unit weight of the soil-left	γ <sub>sat_L</sub>	[kN/m <sup>3</sup> ]	= 18.00
Dry unit weight of the soil-right	γ <sub>d_R</sub>	[kN/m <sup>3</sup> ]	= 18.00
Saturated unit weight of the soil-right	γ <sub>sat_R</sub>	[kN/m <sup>3</sup> ]	= 18.00
Layer thickness	h	[m]	= 10.00

## Result:

Sheet pile length	L	[m]	= 8.99
Minimum sheet pile length	L <sub>m</sub>	[m]	= 7.99
Minimum penetration depth	L <sub>2</sub>	[m]	= 4.99
Resistance force at the toe	R	[kN]	= 132.6
Maximum moment	M <sub>max</sub>	[kN.m]	= 121.74
Moment arm from the ground surface	Y	[m]	= 5.90

## Sheet Pile Wall

Earth pressures on the sheet pile:

No.	Depth	Passive earth pressure from soil weight	Active earth pressure from surcharge	Active earth pressure from soil weight	Earth pressure
I [-]	z [m]	ep [kN/m <sup>2</sup> ]	eq [kN/m <sup>2</sup> ]	ea [kN/m <sup>2</sup> ]	E [kN/m <sup>2</sup> ]
1	0.00	0.00	1.50	0.00	1.50
2	0.50	0.00	1.50	3.00	4.50
3	0.99	0.00	1.50	5.94	7.44
4	1.00	0.00	1.50	6.00	7.50
5	1.01	0.00	1.50	6.06	7.56
6	1.50	0.00	1.50	9.00	10.50
7	2.00	0.00	1.50	12.00	13.50
8	2.50	0.00	1.50	15.00	16.50
9	2.99	0.00	1.50	17.94	19.44
10	3.00	0.00	1.50	18.00	19.50
11	3.01	-0.27	1.50	18.06	19.29
12	3.50	-13.50	1.50	21.00	9.00
13	4.00	-27.00	1.50	24.00	-1.50
14	4.50	-40.50	1.50	27.00	-12.00
15	5.00	-54.00	1.50	30.00	-22.50
16	5.50	-67.50	1.50	33.00	-33.00
17	5.90	-78.30	1.50	35.40	-41.40
18	6.00	-81.00	1.50	36.00	-43.50
19	6.50	-94.50	1.50	39.00	-54.00
20	7.00	-108.00	1.50	42.00	-64.50
21	7.50	-121.50	1.50	45.00	-75.00
22	7.99	-134.73	1.50	47.94	-85.29

Shear Forces/ Moments:

No.	Depth	Shear force	Moment
I	z [m]	Q [kN]	M [kN.m]
1	0.00	0.00	0.00
2	0.50	-1.50	0.31
3	0.99	-4.43	1.71
4	1.00	-4.50	1.75
5	1.01	-4.58	1.80
6	1.50	-9.00	5.06
7	2.00	-15.00	11.00
8	2.50	-22.50	20.31
9	2.99	-31.31	33.44
10	3.00	-31.50	33.75
11	3.01	-31.69	34.07
12	3.50	-38.63	51.50
13	4.00	-40.50	71.50
14	4.50	-37.13	91.12
15	5.00	-28.50	107.75
16	5.50	-14.63	118.75
17	5.90	0.26	121.74
18	6.00	4.50	121.50
19	6.50	28.88	113.37
20	7.00	58.50	91.75
21	7.50	93.38	54.00
22	7.99	132.65	-1.17

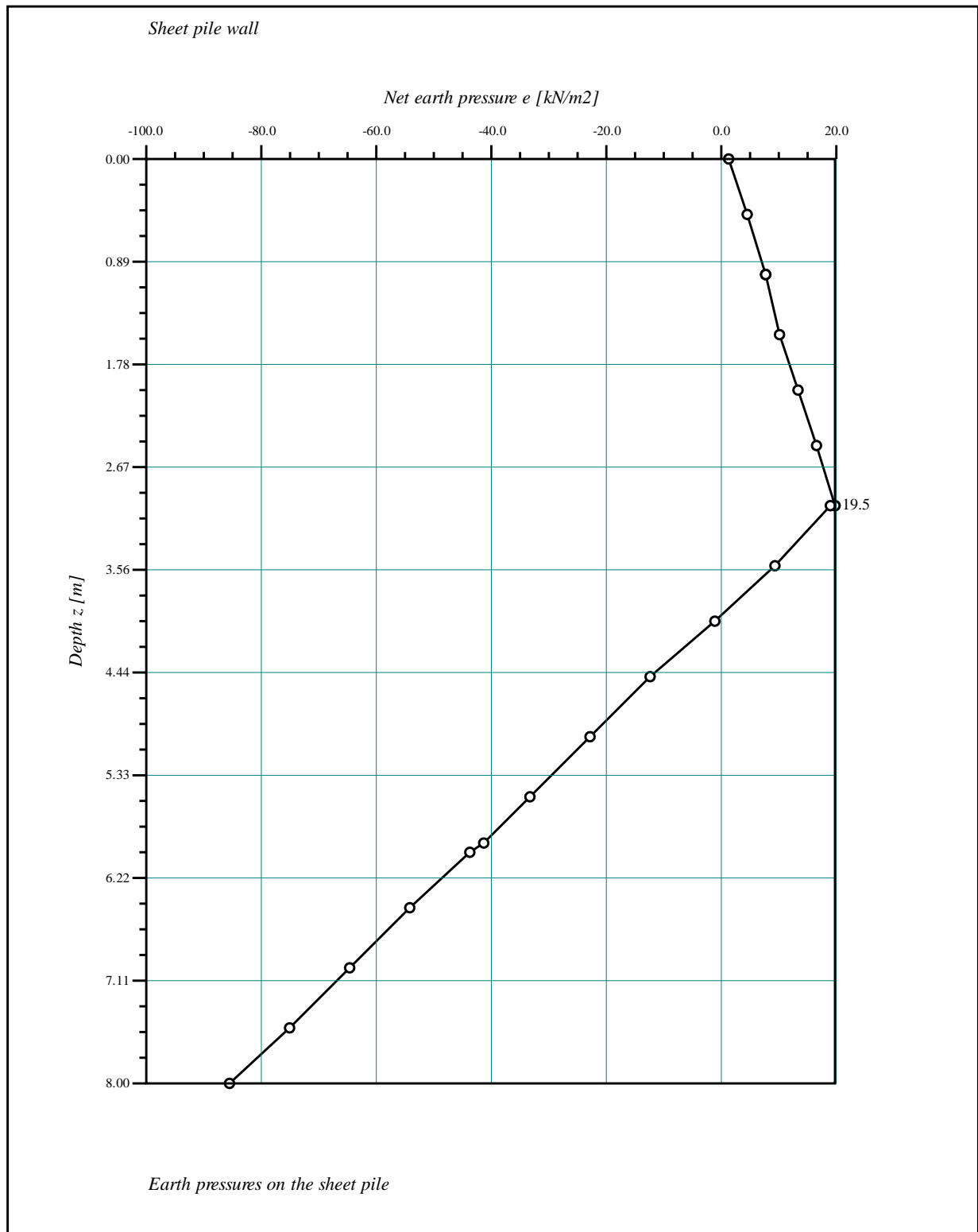

<p><b>GEOTEC Software Inc</b>                  PO Box 14001 Richmond Road PO, Calgary AB, Canada T3E 7Y7</p>	
<p><b>Scale: 804</b>  <b>File: Ex02</b>  <b>Page No.:</b></p>	<p><b>Project: Examples to verify sheet pile wall</b>  <b>Date: 03-11-2021</b>  <b>Title: Cantilever in dry sand with surcharge</b></p>

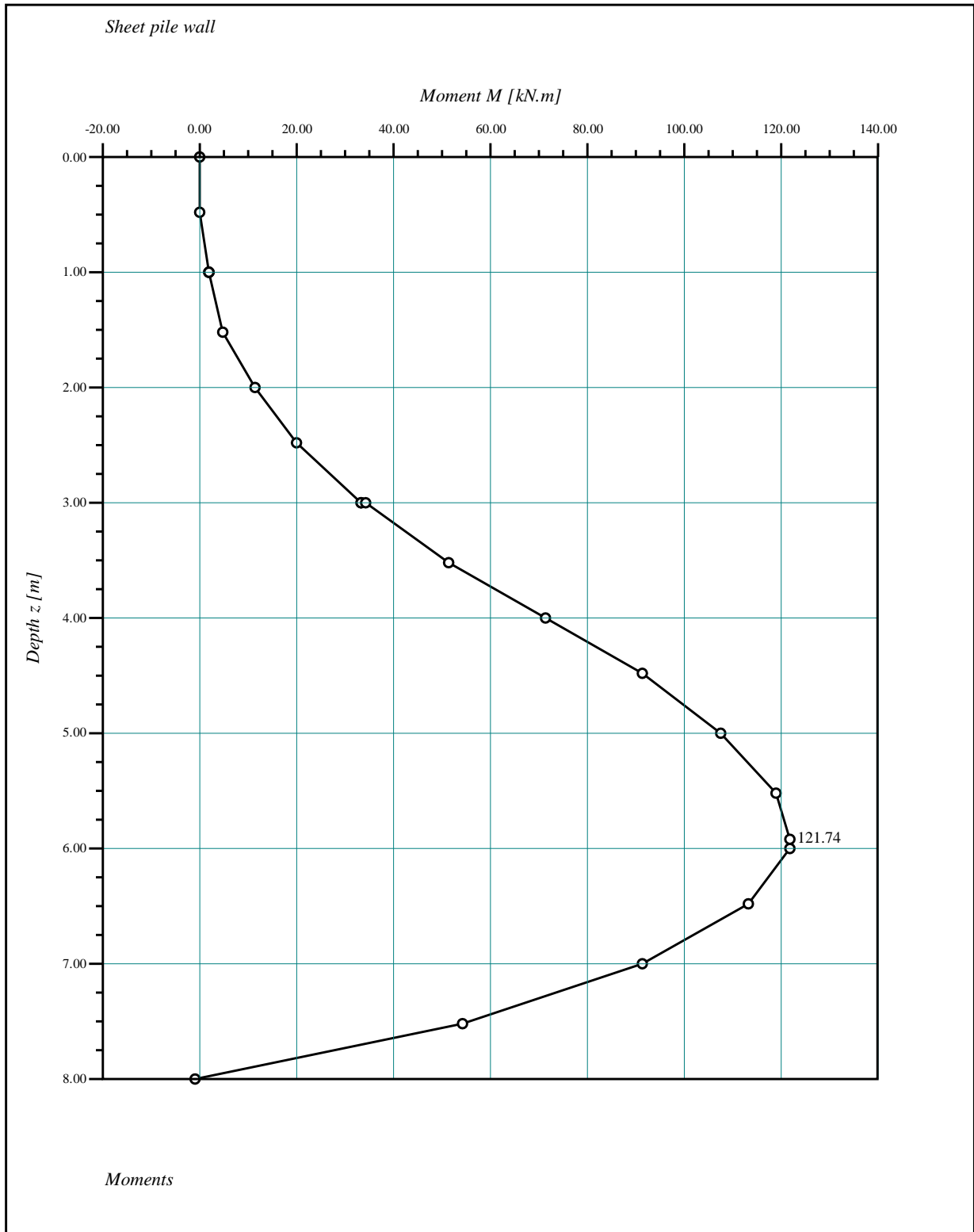

<p><b>GEOTEC Software Inc</b>                  PO Box 14001 Richmond Road PO, Calgary AB, Canada T3E 7Y7</p>	
<p><b>Scale:</b> 952  <b>File:</b> Ex02  <b>Page No.:</b></p>	<p><b>Project:</b> Examples to verify sheet pile wall  <b>Date:</b> 03-11-2021  <b>Title:</b> Cantilever in dry sand with surcharge</p>

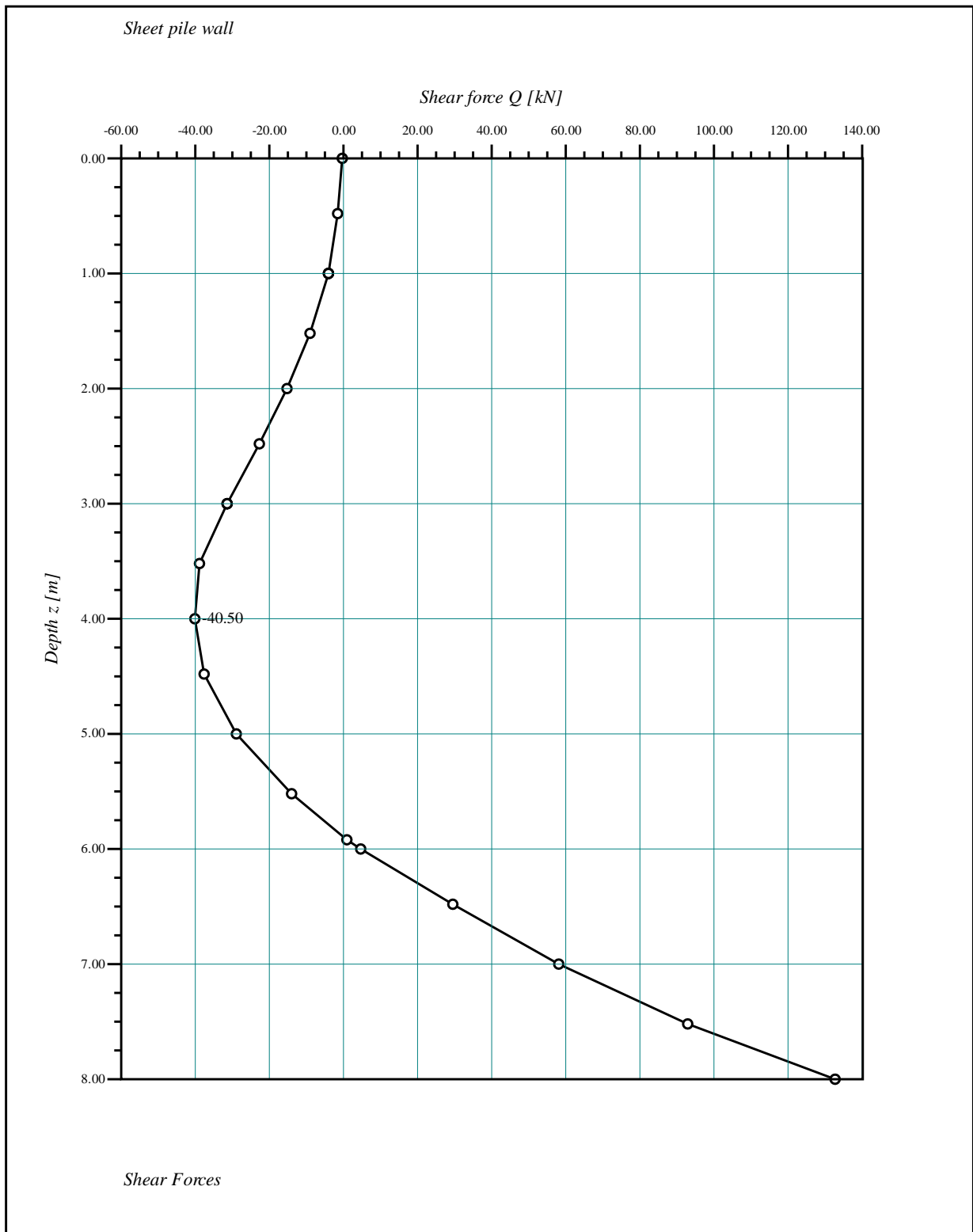

<b>GEOTEC Software Inc</b>	
PO Box 14001 Richmond Road PO, Calgary AB, Canada T3E 7Y7	
Scale: 1243	Project: Examples to verify sheet pile wall
File: Ex02	Date: 03-11-2021
Page No.:	Title: Cantilever in dry sand with surcharge



### 5.5.4 Example 3: Cantilever sheet pile in sand with water table within the backfill

#### 5.5.4.1 Description of the problem

To verify the analysis of the cantilever *sheet* pile in the sand with water table within the backfill, the penetration depth  $d$  for the given cantilever sheet pile in the sand shown in Figure 5.21 is obtained by hand calculation and compared with that obtained by *GEO Tools*. The sides of an excavation 2.25 [m] deep in the sand are to be supported by a cantilever sheet pile wall, the water table being 1.0 [m] below the bottom of the excavation. The unit weight of the sand above the water table is  $\gamma_d = 18$  [kN/m<sup>3</sup>], and the saturated unit weight is  $\gamma_{sat} = 21$  [kN/m<sup>3</sup>] below the water table. Shear parameters are  $c = 0$  [kN/m<sup>2</sup>] and  $\phi = 35$  [°]. A surcharge of  $q = 15$  [kN/m<sup>2</sup>] is applied on the surface. Take a factor of safety for the passive earth pressure  $F_s = 2.0$  [-] and a factor of safety for penetration depth = 20 %.

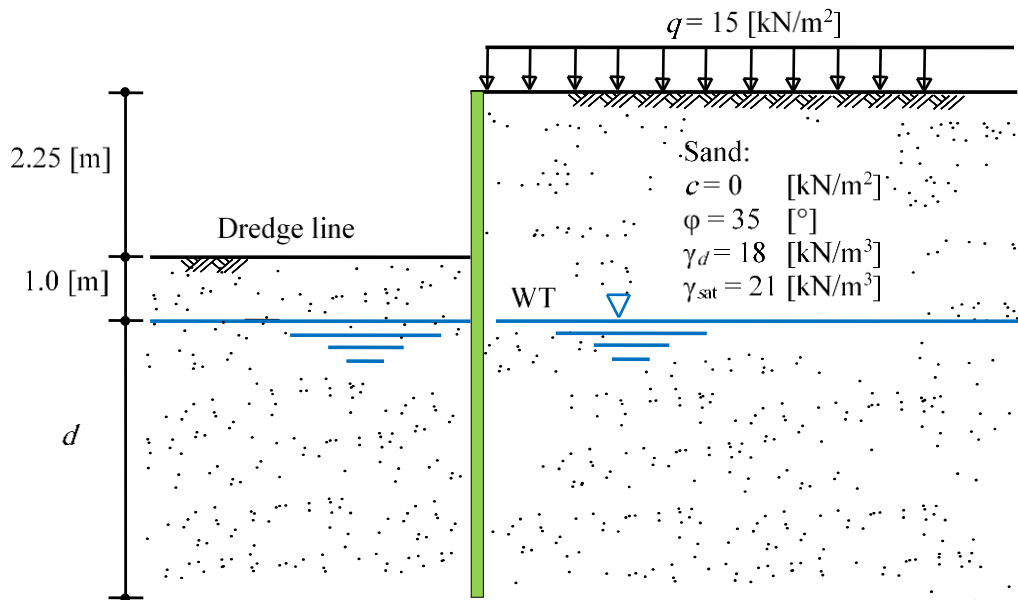

Figure 5.21 Cantilever sheet pile in sand

#### 5.5.4.2 Soil parameters and earth pressure coefficients

Dry unit weight of the soil	$\gamma_d$	= 18 [kN/m <sup>3</sup> ]
Saturated unit weight of the soil	$\gamma_{sat}$	= 21 [kN/m <sup>3</sup> ]
Submerged unit weight of the soil	$\gamma_{Sub}$	= 21 - 9.81 = 11.19 [kN/m <sup>3</sup> ]
Angle of internal friction	$\phi$	= 35 [°]

Active earth pressure coefficient	$k_a$	= $(1 - \sin \phi) / (1 + \sin \phi) = 0.27$
Passive earth pressure coefficient	$k_p$	= $(1 + \sin \phi) / (1 - \sin \phi) = 3.69$
	$k_p / F_s$	= 1.85

#### 5.5.4.3 Determining earth pressures, forces and moments on the wall

The design dimensions and the earth pressure diagrams are shown in Figure 5.22. The procedure is to equate moments about  $o$ , the point of application of the force representing the net passive resistance below the rotation point. Earth pressures on the pile wall are listed in Table 5.8. Forces, arms, and moments are listed in Table 5.9. Passive earth pressure is divided by the specified factor of safety  $F_s$ . The distributions of hydrostatic pressure on the two sides of the wall balance and can be eliminated from the calculations.

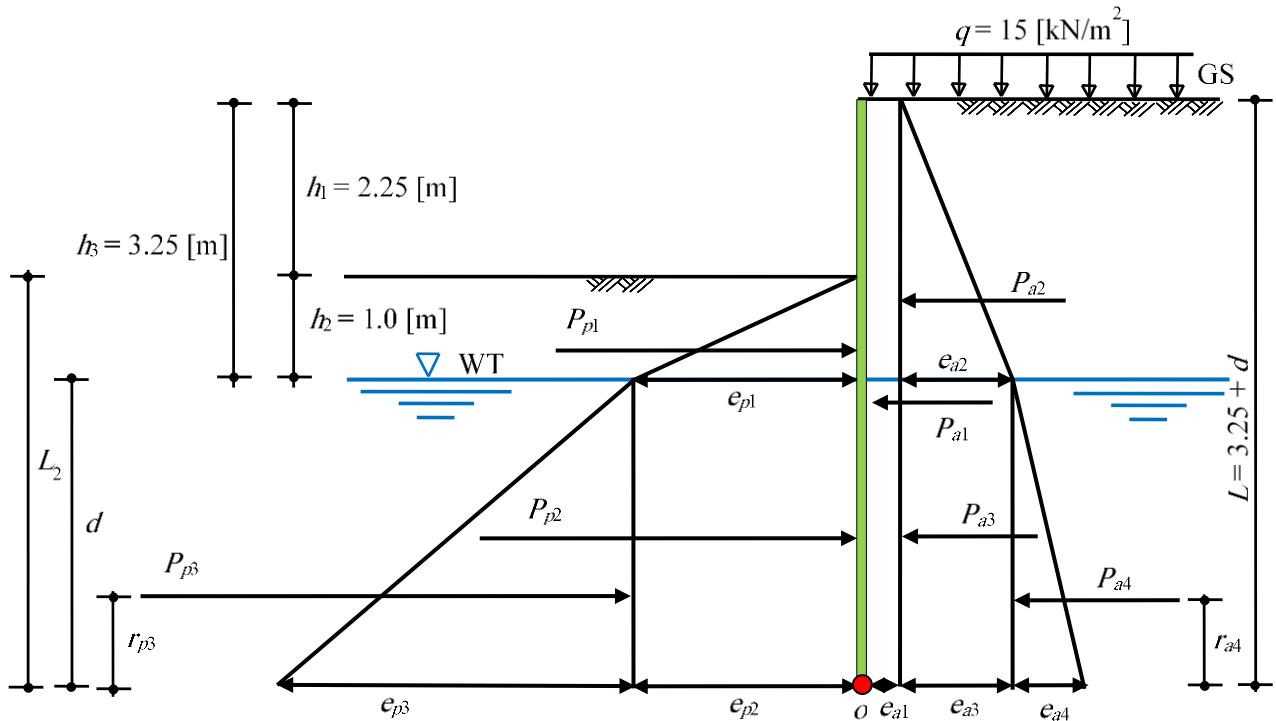

Figure 5.22 Earth pressures diagrams

Table 5.8 Earth pressures on the pile wall

Soil	Earth pressure $e$ [kN/m <sup>2</sup> ]		
Active	$e_{a1} = q k_a$	$= 15 \times 0.27$	$= 4.05$
	$e_{a2} = \gamma_s h_3 k_a$	$= 18 \times 3.25 \times 0.27$	$= 15.80$
	$e_{a3} = e_{a2}$	$= 18 \times 3.25 \times 0.27$	$= 15.80$
	$e_{a4} = \gamma_{sub} d k_a$	$= 11.19 \times d \times 0.27$	$= 3.02 \times d$
Passive	$e_{p1} = \gamma_s h_2 k_p / F_S$	$= 18 \times 1.0 \times 1.85$	$= 33.21$
	$e_{p2} = e_{p1}$	$= 18 \times 1.0 \times 1.85$	$= 33.21$
	$e_{p3} = \gamma_{sub} d k_p / F_S$	$= 11.19 \times d \times 1.85$	$= 20.65 \times d$

Table 5.9 Earth forces on the pile wall and moments about point  $o$

Soil	Force $P$ [kN]	Arm from $o$ $r$ [m]	Moment @ $o$ $M = P \times r$ [kN.m]
Active	$P_{a1} = e_{a1}(h_3+d) = 4.05 d + 13.16$	$(3.25+d)/2$	$M_{a1} = 2.03 d^2 + 13.16 d + 21.39$
	$P_{a2} = 0.5 e_{a2} h_3 = 25.68$	$1.08+d$	$M_{a2} = 25.68 d + 27.81$
	$P_{a3} = e_{a3} d = 15.80 d$	$d/2$	$M_{a3} = 7.9 d^2$
	$P_{a4} = 0.5 e_{a4} d = 1.51 d^2$	$d/3$	$M_{a4} = 0.5 d^3$
	$P_{at} = \Sigma P_a = 1.51 d^2 + 19.85 d + 38.84$		$M_{at} = \Sigma M_a = 0.5d^3 + 9.93d^2 + 38.84d + 49.2$
Passive	$P_{p1} = 0.5 e_{p1} h_2 = 16.61$	$0.333+d$	$M_{p1} = 16.61 d + 5.54$
	$P_{p2} = e_{p2} d = 33.21 d$	$d/2$	$M_{p2} = 16.61 d^2$
	$P_{p3} = 0.5 e_{p3} d = 10.33 d^2$	$d/3$	$M_{p3} = 3.44 d^3$
	$P_{pt} = \Sigma P_p = 10.33 d^2 + 33.21 d + 16.61$		$M_{pt} = \Sigma M_p = 3.44d^3 + 16.61d^2 + 16.61d + 5.54$

**5.5.4.4 Determining penetration depth and pile length**

Equating active and passive moments about  $o$ ,  $M_{at} = M_{pt}$

$$0.5 d^3 + 9.93 d^2 + 38.84 d + 49.2 = 3.44 d^3 + 16.61 d^2 + 16.61 d + 5.54$$

or

$$d^3 + 2.27 d^2 - 7.56 d - 14.85 = 0$$

Solving the above equation gives:

$$d = 2.66 \text{ [m]}$$

$$\text{Min penetration depth } L_2 = (h_2 + d) = 1 + 2.66 = 3.66$$

Factor of safety for penetration depth = 20%. Therefore, the penetration depth with an additional 20% is:

$$\text{Penetration depth } d_p = 1.2 \times L_2 = 1.2 \times 3.66 = 4.39 \text{ [m]}$$

$$\text{Pile wall length } L = h_1 + d_p = 2.25 + 4.39 = 6.64 \text{ [m]}$$

Figure 5.23 shows earth pressure diagrams in a single view.

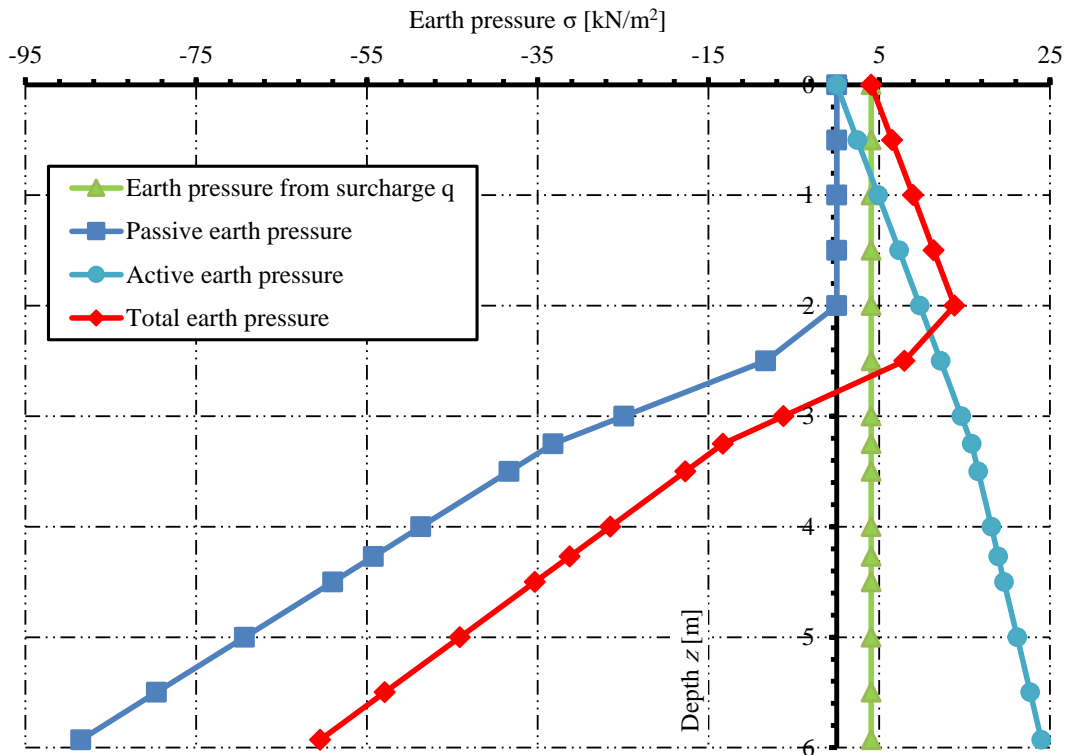

Figure 5.23 Earth pressures diagrams

#### 5.5.4.5 Design of sheet pile wall

##### 5.5.4.5.1 Point of zero shear

Point of zero shear is determined from equating active and passive forces  $P_a(y) = P_p(y)$  at distance  $y$  below the water table.

$$1.51 y^2 + 19.85 y + 38.84 = 10.33 y^2 + 33.21 y + 16.61$$

or

$$y^2 + 1.52 y - 2.52 = 0$$

Solving the above equation, gives the point of zero shear at distance  $y$  as:

$$y = \frac{-1.52 \pm \sqrt{1.52^2 + 4 \times 2.52}}{2} = 1.0 \text{ [m]}$$

Moment arm from the ground surface = 4.25 [m]

**5.5.4.5.2 Max. Moment**

Maximum moment on the wall is calculated in Table 5.10.

Table 5.10 Determining maximum moment  $M_{max}$

Soil	Moment $M = P \times r$ [kN.m]
Active	$M_{at} = 0.5 y^3 + 9.93 y^2 + 38.84 y + 49.2 = 98.47$
Passive	$M_{pt} = 3.44 y^3 + 16.61 y^2 + 16.61 y + 5.54 = 42.2$
	$M_{max} = M_{at} - M_{pt} = 56.27$

**5.5.4.6 Penetration depth by GEO Tools**

The penetration depth obtained by *GEO Tools* for the cantilever sheet pile in the sand is equal to that obtained by hand calculation. The input data and results of *GEO Tools* for this example are presented on the next pages.

\*\*\*\*\*

GEO Tools  
Version 12.2

Program authors Prof. M. El Gendy/ Dr. A. El Gendy

\*\*\*\*\*

Title: Cantilever sheet pile in sand with water table within the backfill

Date: 03-11-2021

Project: Examples to verify sheet pile wall

File: Ex03 Cantilever in sand with WT

-----  
Cantilever sheet pile wall  
-----

Data:

Distributed load	q	[kN/m2]	= 15.00
Safety factor for passive resistance	Fs1	[-]	= 2.00
Safety factor for penetration depth	Fs2	[-]	= 1.20
Depth of dredge line	L1	[m]	= 2.25

Soil Data:

Ground water depth-left	Gwl_L	[m]	= 3.25
Ground water depth-right	Gwl_R	[m]	= 3.25

Layer No.: 1

Cohesion of the soil	C	[kN/m2]	= 0.000
Angle of internal friction	$\phi$	[°]	= 35.00
Dry unit weight of the soil-left	$\gamma_{d\_L}$	[kN/m3]	= 18.00
Saturated unit weight of the soil-left	$\gamma_{sat\_L}$	[kN/m3]	= 21.00
Dry unit weight of the soil-right	$\gamma_{d\_R}$	[kN/m3]	= 18.00
Saturated unit weight of the soil-right	$\gamma_{sat\_R}$	[kN/m3]	= 21.00
Layer thickness	h	[m]	= 10.00

Result:

Sheet pile length	L	[m]	= 6.67
Minimum sheet pile length	Lm	[m]	= 5.93
Minimum penetration depth	L2	[m]	= 3.68
Resistance force at the toe	R	[kN]	= 76.5
Maximum moment	Mmax	[kN.m]	= 56.62
Moment arm from the ground surface	Y	[m]	= 4.27

## Sheet Pile Wall

Earth pressures on the sheet pile:

No.	Depth	Passive earth pressure from soil weight	Water pressure left	Active earth pressure from surcharge	Active earth pressure from soil weight	Water pressure right	Earth pressure
I	z	ep	wl	eq	ea	wr	E
[-]	[m]	[kN/m <sup>2</sup> ]	[kN/m <sup>2</sup> ]	[kN/m <sup>2</sup> ]	[kN/m <sup>2</sup> ]	[kN/m <sup>2</sup> ]	[kN/m <sup>2</sup> ]
1	0.00	0.00	0.00	4.06	0.00	0.00	4.06
2	0.50	0.00	0.00	4.06	2.44	0.00	6.50
3	0.99	0.00	0.00	4.06	4.83	0.00	8.89
4	1.00	0.00	0.00	4.06	4.88	0.00	8.94
5	1.01	0.00	0.00	4.06	4.93	0.00	8.99
6	1.50	0.00	0.00	4.06	7.32	0.00	11.38
7	2.00	0.00	0.00	4.06	9.76	0.00	13.82
8	2.24	0.00	0.00	4.06	10.93	0.00	14.99
9	2.25	0.00	0.00	4.06	10.98	0.00	15.04
10	2.26	-0.33	0.00	4.06	11.02	0.00	14.76
11	2.50	-8.30	0.00	4.06	12.19	0.00	7.96
12	3.00	-24.91	0.00	4.06	14.63	0.00	-6.21
13	3.25	-33.21	0.00	4.06	15.85	0.00	-13.29
14	3.50	-38.37	-2.45	4.06	16.61	2.45	-17.70
15	4.00	-48.70	-7.36	4.06	18.13	7.36	-26.50
16	4.27	-54.27	-10.01	4.06	18.95	10.01	-31.26
17	4.50	-59.02	-12.26	4.06	19.64	12.26	-35.31
18	5.00	-69.34	-17.17	4.06	21.16	17.17	-44.12
19	5.50	-79.67	-22.07	4.06	22.68	22.07	-52.93
20	5.93	-88.54	-26.29	4.06	23.98	26.29	-60.50

Shear Forces/ Moments:

No.	Depth	Shear force	Moment
I	z	Q	M
	[m]	[kN]	[kN.m]
1	0.00	0.00	0.00
2	0.50	-2.64	0.61
3	0.99	-6.41	2.78
4	1.00	-6.50	2.85
5	1.01	-6.59	2.91
6	1.50	-11.58	7.32
7	2.00	-17.89	14.63
8	2.24	-21.34	19.34
9	2.25	-21.49	19.55
10	2.26	-21.64	19.77
11	2.50	-24.37	25.32
12	3.00	-24.80	37.91
13	3.25	-22.37	43.84
14	3.50	-18.49	48.97
15	4.00	-7.44	55.64
16	4.27	0.36	56.62
17	4.50	8.01	55.68
18	5.00	27.87	46.89
19	5.50	52.13	27.07
20	5.93	76.52	-0.47

Sheet pile wall

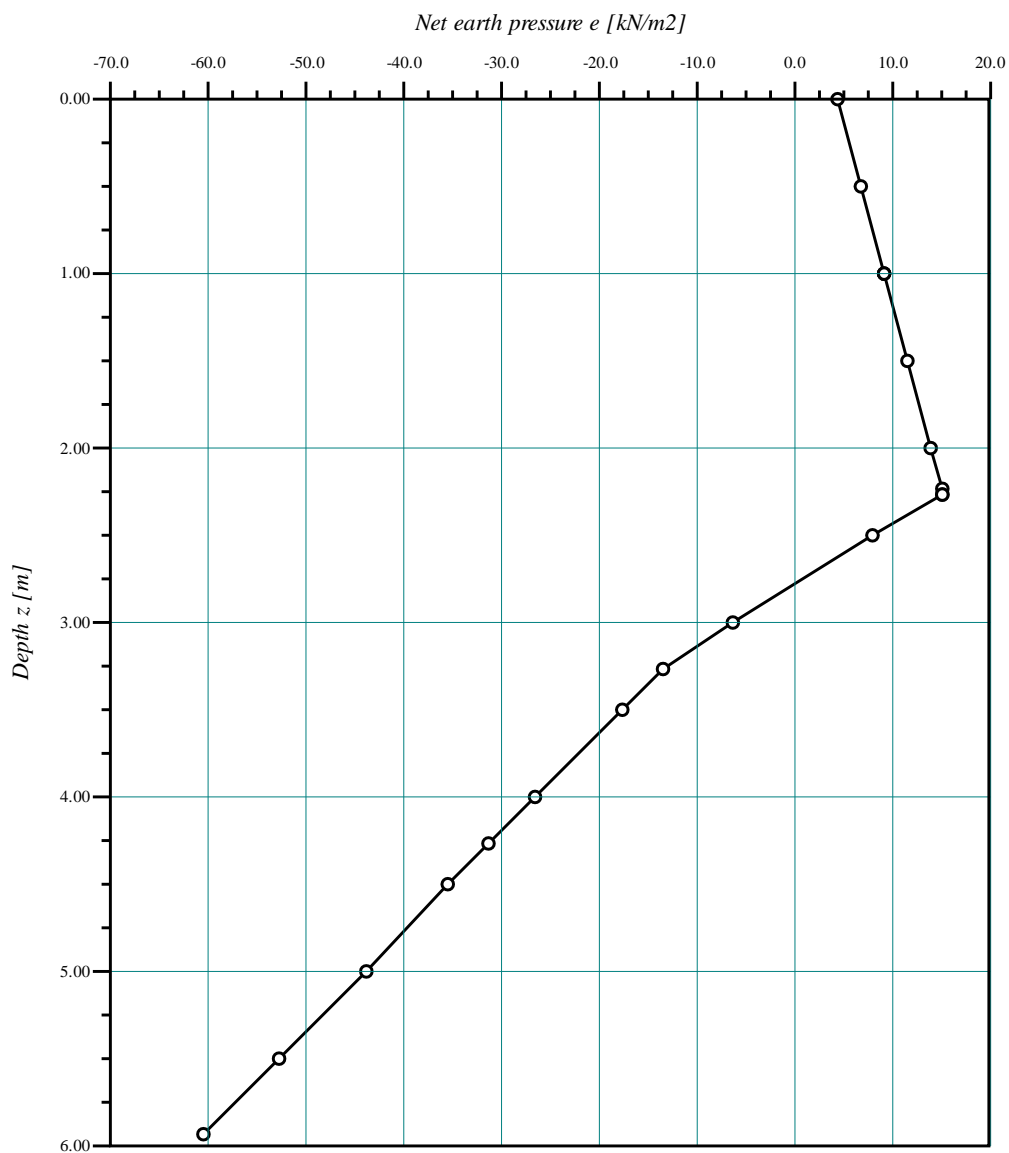

Earth pressures on the sheet pile

GEOTEC Software Inc

PO Box 14001 Richmond Road PO, Calgary AB, Canada T3E 7Y7

Scale: 595

File: Ex03

Page No.:

Project: Examples to verify sheet pile wall

Date: 03-11-2021

Title: Cantilever sheet pile in sand with water table within the backfill



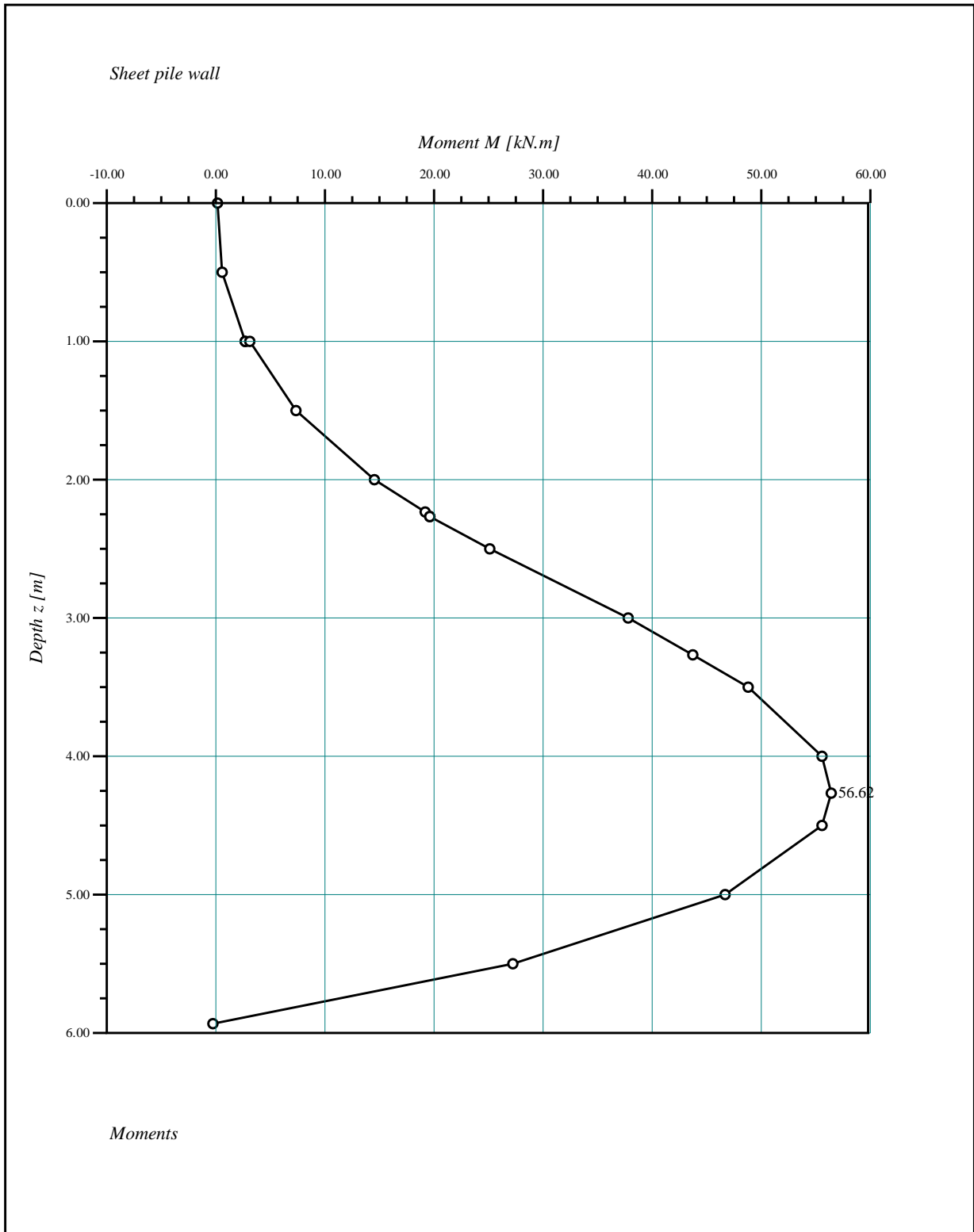

<p><b>GEOTEC Software Inc</b>                  PO Box 14001 Richmond Road PO, Calgary AB, Canada T3E 7Y7</p>	
<p>Scale: 423                  File: Ex03                  Page No.:</p>	<p>Project: Examples to verify sheet pile wall                  Date: 03-11-2021                  Title: Cantilever sheet pile in sand with water table within the backfill</p>

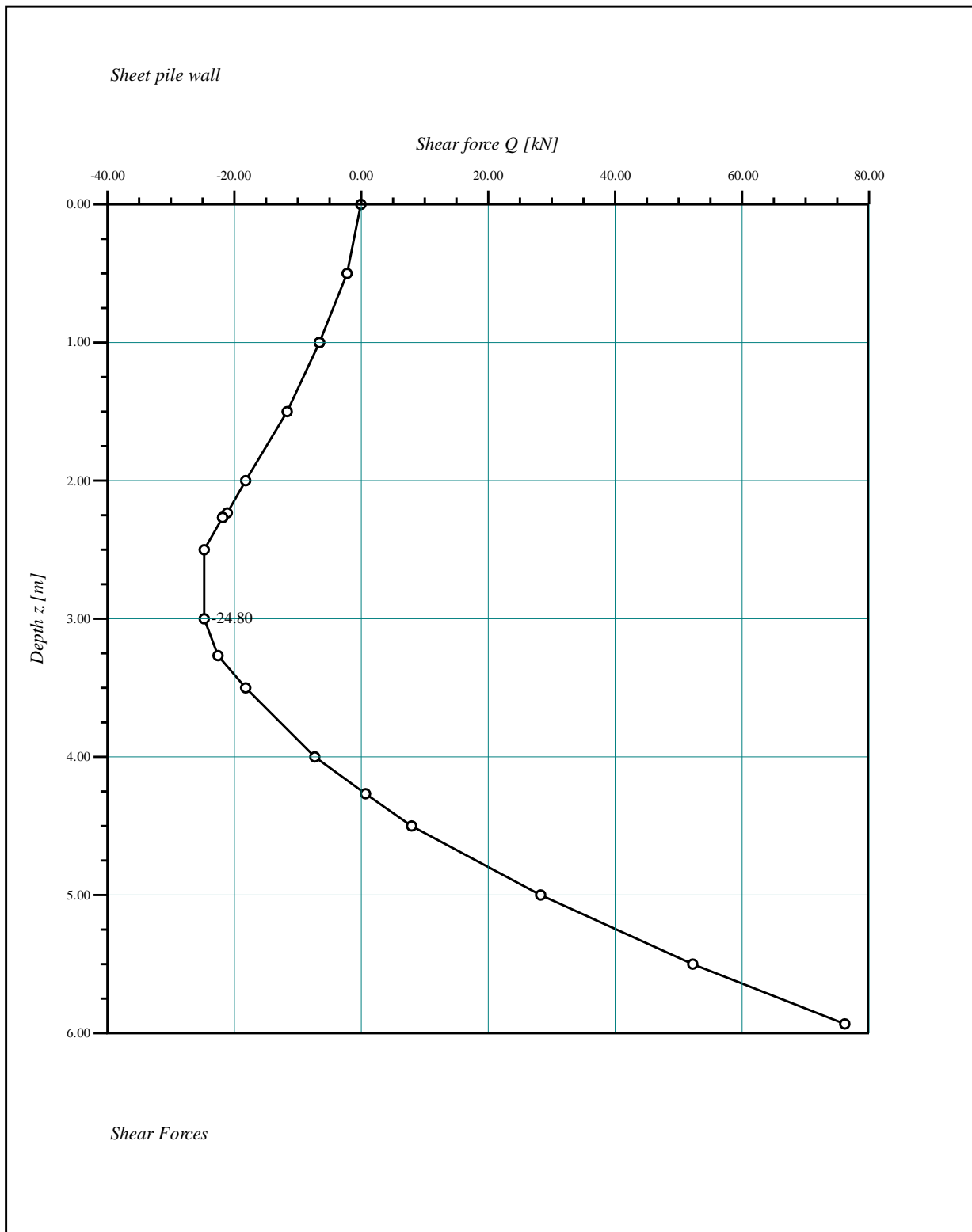

<p><b>GEOTEC Software Inc</b>                  PO Box 14001 Richmond Road PO, Calgary AB, Canada T3E 7Y7</p>	
<p>Scale: 726                  File: Ex03                  Page No.:</p>	<p>Project: Examples to verify sheet pile wall                  Date: 03-11-2021                  Title: Cantilever sheet pile in sand with water table within the backfill</p>

### 5.5.5 Example 4: Cantilever sheet pile penetrating in clay

#### 5.5.5.1 Description of the problem

To verify the analysis of cantilever sheet pile penetrating in clay, the theoretical penetration depth  $d$  for the given cantilever sheet pile penetrating in clay in Figure 5.24 is obtained by hand calculation and compared with that obtained by *GEO Tools*. The sides of an excavation 5.0 [m] deep are to be supported by a cantilever sheet pile wall. The unit weight and shear parameters of the soil layers are shown in Figure 5.24.

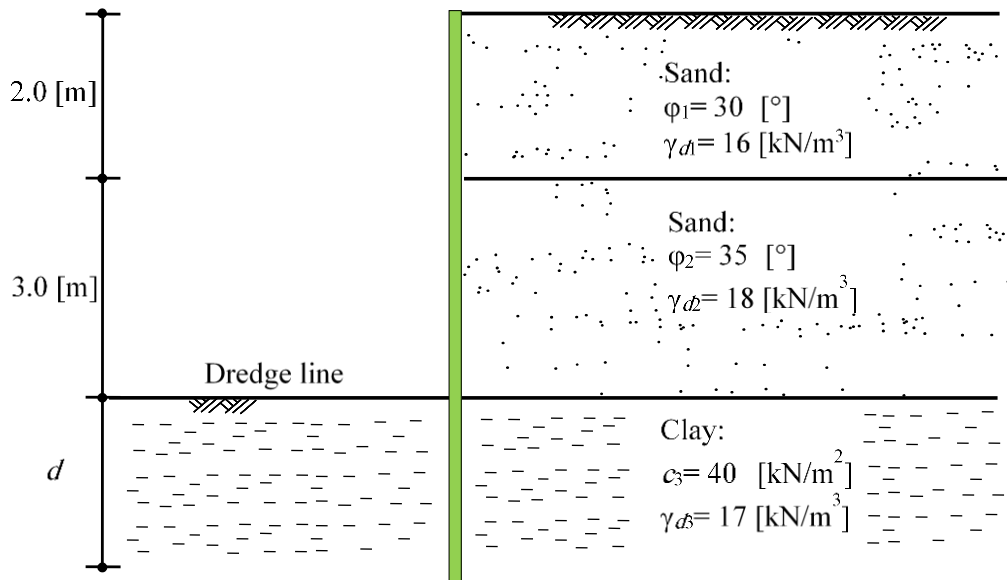

Figure 5.24 Cantilever sheet pile penetrating in clay

#### 5.5.5.2 Soil parameters and earth pressure coefficients

First layer:

Unit weight of the soil	$\gamma_{d1}$	= 16	[kN/m <sup>3</sup> ]
Angle of internal friction	$\phi_1$	= 30	[°]
Active earth pressure coefficient	$k_{a1}$	= $(1 - \sin \phi) / (1 + \sin \phi)$	= 0.33

Second layer:

Unit weight of the soil	$\gamma_{d2}$	= 18	[kN/m <sup>3</sup> ]
Angle of internal friction	$\phi_2$	= 35	[°]
Active earth pressure coefficient	$k_{a2}$	= $(1 - \sin \phi) / (1 + \sin \phi)$	= 0.27

Third layer:

Unit weight of the soil	$\gamma_{d3}$	= 17	[kN/m <sup>3</sup> ]
Angle of internal friction	$\phi_3$	= 0	[°]
Cohesion of the soil	$c_3$	= 40	[kN/m <sup>2</sup> ]
Active earth pressure coefficient	$k_{a3}$	= $(1 - \sin \phi) / (1 + \sin \phi)$	= 1
Passive earth pressure coefficient	$k_{p3}$	= $1 / k_{a3}$	= 1

#### 5.5.5.3 Determining earth pressures, forces and moments on the wall

The design dimensions and the earth pressure diagrams are shown in Figure 5.25. The procedure is to equate moments about  $o$ , the point of application of the force representing the net passive resistance below the rotation point. Earth pressures on the pile wall are listed in Table 5.11. Forces, arms, and moments are listed in Table 5.12.

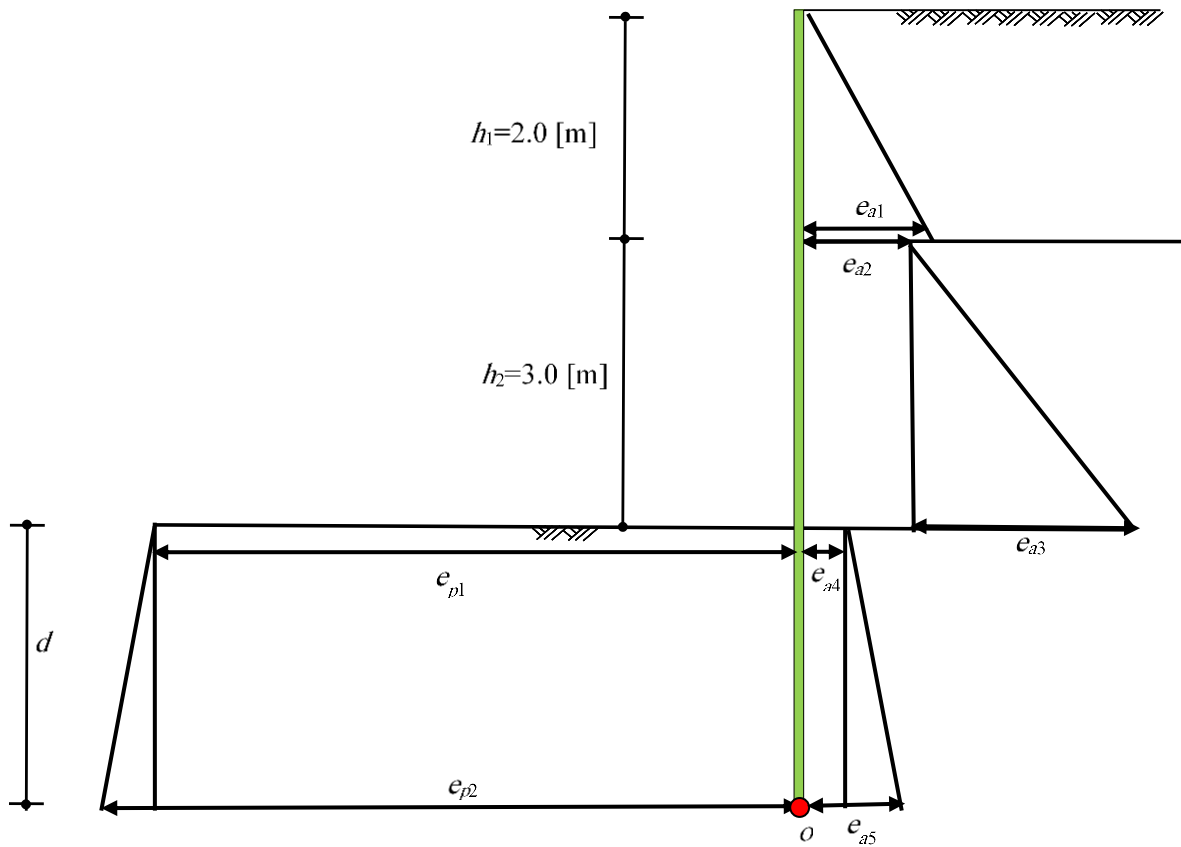

Figure 5.25 Earth pressures diagrams

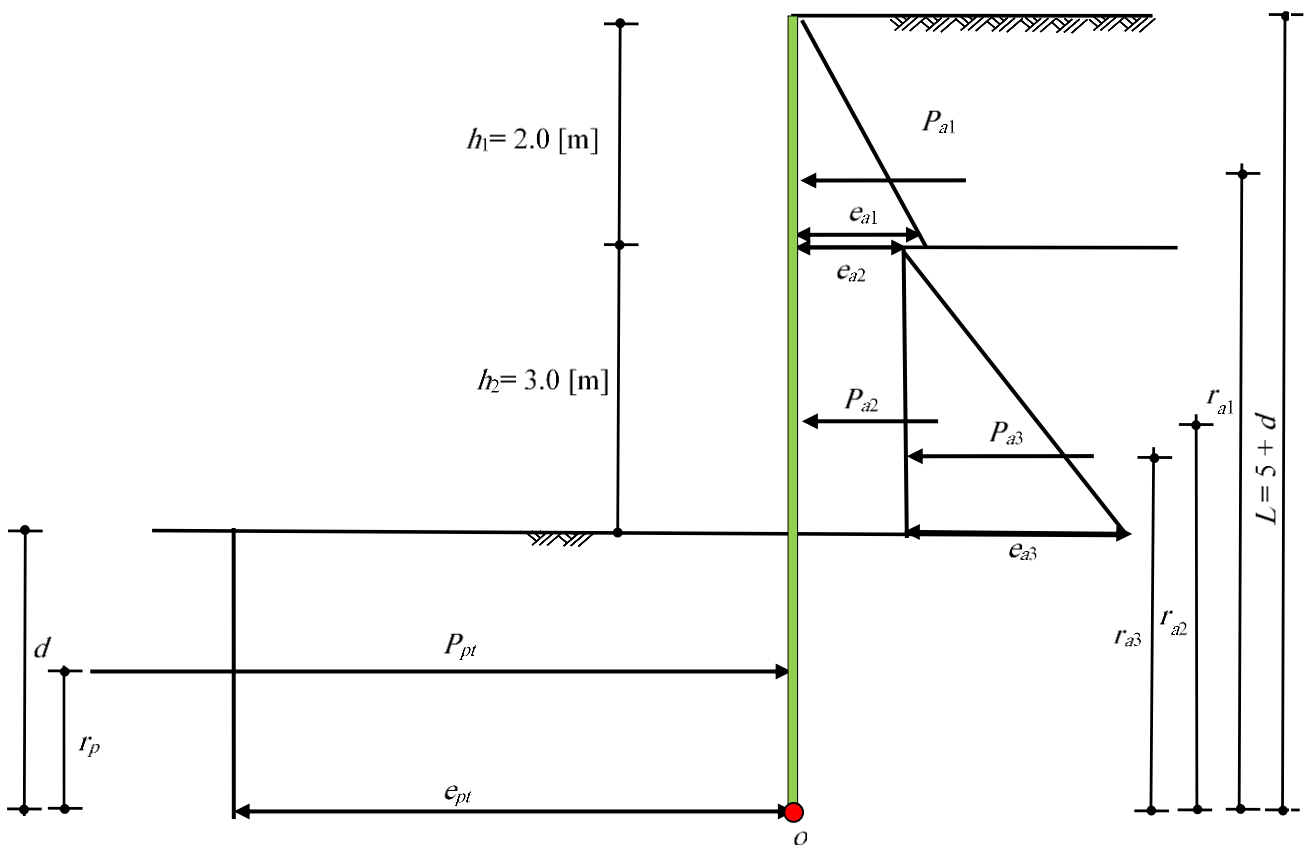

Figure 5.26 Net earth pressures diagrams

In the analysis, it is convenient to obtain the net earth pressure distribution under the dredge line. This is done by subtracting the active earth pressure from the passive earth pressure under the dredge line.

Figure 5.26 shows the net earth pressure diagrams. From Figure 5.25, Figure 5.26, and Table 5.11. The net passive pressure in the case of homogenous soil under the dredge line with  $\phi = 0$  and  $c \neq 0$  will be  $e_{pt} = 4c - q$ .

Table 5.11 Earth pressures on the pile wall

Soil	Earth pressure $e$ [kN/m <sup>2</sup> ]		
Active	$e_{a1} = \gamma_{d1} h_1 k_{a1}$	$= 16 \times 2 \times 0.33$	$= 10.67$
	$e_{a2} = \gamma_{d1} h_1 k_{a2}$	$= 16 \times 2 \times 0.27$	$= 8.64$
	$e_{a3} = \gamma_{d2} h_2 k_{a2}$	$= 18 \times 3 \times 0.27$	$= 14.58$
	$e_{a4} = (\gamma_{d1} h_1 + \gamma_{d2} h_2) k_{a3} - 2c_3 \sqrt{k_{a3}}$ $= q - 2c_3$	$= (16 \times 2 + 18 \times 3) \times 1 - 2 \times 40 \sqrt{1}$	$= 6$
	$e_{a5} = e_{a4} + \gamma_{d3} d k_{a3}$ $= q - 2c_3 + \gamma_{d3} d$	$= 6 + 17 \times d \times 1$	$= 6 + 17d$
Passive	$e_{p1} = 2c_3 \sqrt{k_{p3}}$ $= 2c_3$	$= 80$	$= 80$
	$e_{p2} = \gamma_{d3} d k_{p3} + 2c_3 \sqrt{k_{p3}}$ $= \gamma_{d3} d + 2c_3$	$= 17 \times d \times 1 + 80$	$= 80 + 17d$
Net passive	$e_{pt1} = e_{p1} - e_{a4} = 2c_3 - (q - 2c_3)$ $= 4c - q$	$= 80 - 6$ $= 4 \times 41 - (16 \times 2 + 18 \times 3)$	$= 74 (-)$ $= 74 (-)$
	$e_{pt2} = e_{p2} - e_{a5}$ $= \gamma_{d3} d + 2c_3 - (q - 2c_3 + \gamma_{d3} d)$ $= 4c - q$	$= 80 + 17d - 6 - 17d$ $= 4 \times 41 - (16 \times 2 + 18 \times 3)$	$= 74 (-)$ $= 74 (-)$

Table 5.12 Earth forces on the pile wall and moments about point  $o$

Soil	Force $P$ [kN]	Arm from $o$ $r$ [m]	Moment @ $o$ $M = P \times r$ [kN.m]
Active	$P_{a1} = 0.5 e_{a1} h_1 = 10.67$	$3.67 + d$	$M_{a1} = 10.67 d + 39.12$
	$P_{a2} = e_{a2} h_2 = 25.92$	$1.5 + d$	$M_{a2} = 25.92 d + 38.88$
	$P_{a3} = 0.5 e_{a3} h_2 = 21.87$	$1 + d$	$M_{a3} = 21.87 d + 21.87$
	$P_{at} = \Sigma P_a = 58.46$		
Passive	$P_{pt} = e_{pt} d = 74 d$	$d/2$	$M_p = 37 d^2$

#### 5.5.5.4 Determining penetration depth and pile length

Equating active and passive moments about  $o$ ,  $M_{at} = M_{pt}$

$$58.46 d + 99.87 = 37 d^2$$

or

$$37 d^2 - 58.46 d - 99.87 = 0$$

$$d^2 - 1.58 d - 2.7 = 0$$

Solving the above equation gives:

$$d = 2.61 \text{ [m]}$$

Pile wall length  $L = h_1 + h_2 + d = 2 + 3 + 2.61 = 7.61 \text{ [m]}$

Figure 5.27 shows net earth pressure diagram.

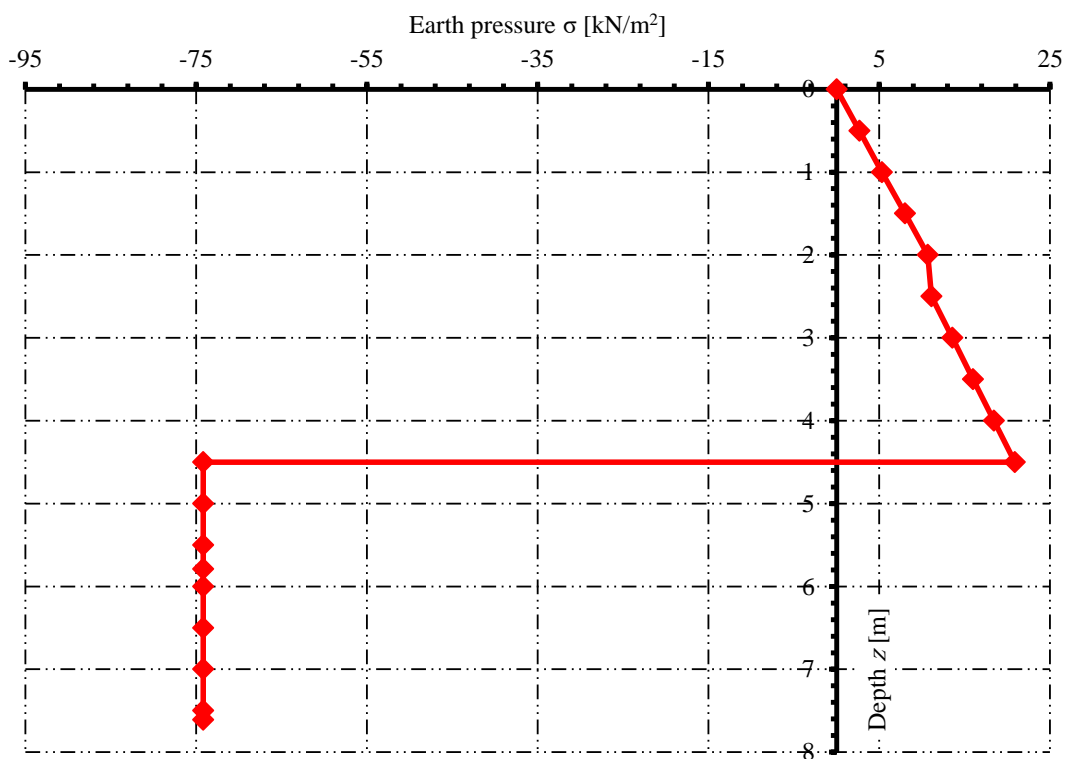

Figure 5.27 Net earth pressures diagram

**5.5.5.5 Design of sheet pile wall**

**5.5.5.5.1 Point of zero shear**

Point of zero shear is determined from equating active and passive forces  $P_a(y) = P_p(y)$  at distance  $y$  below the dredge line.

$$58.46 = 74 y$$

$$y = 0.79 \text{ [m]}$$

$$\text{Moment arm from the ground surface} = h_1 + h_2 + d = 2 + 3 + 0.79 = 5.79 \text{ [m]}$$

**5.5.5.5.2 Max. Moment**

Maximum moment on the wall is calculated in Table 5.13.

Table 5.13 Determining maximum moment  $M_{max}$

Soil	Moment $M = P \times r$ [kN.m]
Active	$M_{at} = 58.46 y + 99.87 = 146.05$
Passive	$M_{pt} = 37 d^2 = 23.09$
	$M_{max} = M_{at} - M_{pt} = 122.96$

**5.5.5.6 Penetration depth by GEO Tools**

The penetration depth obtained by *GEO Tools* for the cantilever sheet pile penetrating in clay is equal to that obtained by hand calculation. The input data and results of *GEO Tools* for this example are presented on the next pages.

\*\*\*\*\*

GEO Tools  
Version 12.2

Program authors Prof. M. El Gendy/ Dr. A. El Gendy

\*\*\*\*\*

Title: Cantilever sheet pile penetrating in clay

Date: 02-11-2021

Project: Examples to verify sheet pile wall

File: Ex04 Cantilever in clay

-----  
Cantilever sheet pile wall  
-----

## Data:

Distributed load	q	[kN/m <sup>2</sup> ]	= 0.00
Safety factor for passive resistance	Fs1	[-]	= 1.00
Safety factor for penetration depth	Fs2	[-]	= 1.00
Depth of dredge line	L1	[m]	= 5.00

## Soil Data:

Ground water depth-left	Gwl_L	[m]	= 10.00
Ground water depth-right	Gwl_R	[m]	= 10.00

## Layer No.: 1

Cohesion of the soil	C	[kN/m <sup>2</sup> ]	= 0.000
Angle of internal friction	φ	[°]	= 30.00
Dry unit weight of the soil-left	γ <sub>d_L</sub>	[kN/m <sup>3</sup> ]	= 16.00
Saturated unit weight of the soil-left	γ <sub>sat_L</sub>	[kN/m <sup>3</sup> ]	= 16.00
Dry unit weight of the soil-right	γ <sub>d_R</sub>	[kN/m <sup>3</sup> ]	= 16.00
Saturated unit weight of the soil-right	γ <sub>sat_R</sub>	[kN/m <sup>3</sup> ]	= 16.00
Layer thickness	h	[m]	= 2.00

## Layer No.: 2

Cohesion of the soil	C	[kN/m <sup>2</sup> ]	= 0.000
Angle of internal friction	φ	[°]	= 35.00
Dry unit weight of the soil-left	γ <sub>d_L</sub>	[kN/m <sup>3</sup> ]	= 18.00
Saturated unit weight of the soil-left	γ <sub>sat_L</sub>	[kN/m <sup>3</sup> ]	= 18.00
Dry unit weight of the soil-right	γ <sub>d_R</sub>	[kN/m <sup>3</sup> ]	= 18.00
Saturated unit weight of the soil-right	γ <sub>sat_R</sub>	[kN/m <sup>3</sup> ]	= 18.00
Layer thickness	h	[m]	= 3.00

## Layer No.: 3

Cohesion of the soil	C	[kN/m <sup>2</sup> ]	= 40.000
Angle of internal friction	φ	[°]	= 0.00
Dry unit weight of the soil-left	γ <sub>d_L</sub>	[kN/m <sup>3</sup> ]	= 17.00
Saturated unit weight of the soil-left	γ <sub>sat_L</sub>	[kN/m <sup>3</sup> ]	= 17.00
Dry unit weight of the soil-right	γ <sub>d_R</sub>	[kN/m <sup>3</sup> ]	= 17.00
Saturated unit weight of the soil-right	γ <sub>sat_R</sub>	[kN/m <sup>3</sup> ]	= 17.00
Layer thickness	h	[m]	= 5.00

## Result:

Sheet pile length	L	[m]	= 7.61
Minimum sheet pile length	L <sub>m</sub>	[m]	= 7.61
Minimum penetration depth	L <sub>2</sub>	[m]	= 2.61
Resistance force at the toe	R	[kN]	= 135.5
Maximum moment	M <sub>max</sub>	[kN.m]	= 122.91
Moment arm from the ground surface	Y	[m]	= 5.79



## Sheet Pile Wall

Earth pressures on the sheet pile:

No.	Depth	Passive earth pressure from soil weight ep [kN/m <sup>2</sup> ]	Active earth pressure from soil weight ea [kN/m <sup>2</sup> ]	Earth pressure E [kN/m <sup>2</sup> ]
I [-]	z [m]			
1	0.00	0.00	0.00	0.00
2	0.50	0.00	2.67	2.67
3	0.99	0.00	5.28	5.28
4	1.00	0.00	5.33	5.33
5	1.01	0.00	5.39	5.39
6	1.50	0.00	8.00	8.00
7	1.99	0.00	10.61	10.61
8	2.00	0.00	10.67	10.67
9	2.01	0.00	8.72	8.72
10	2.50	0.00	11.11	11.11
11	3.00	0.00	13.55	13.55
12	3.50	0.00	15.99	15.99
13	4.00	0.00	18.43	18.43
14	4.50	0.00	20.87	20.87
15	4.99	0.00	23.26	23.26
16	5.00	-80.17	5.99	-74.18
17	5.01	-80.34	6.16	-74.18
18	5.50	-88.67	14.49	-74.18
19	5.79	-93.60	19.42	-74.18
20	6.00	-97.17	22.99	-74.18
21	6.50	-105.67	31.49	-74.18
22	7.00	-114.17	39.99	-74.18
23	7.50	-122.67	48.49	-74.18
24	7.61	-124.54	50.36	-74.18

## Shear Forces/ Moments:

---

No.	Depth	Shear force	Moment
I	z	Q	M
	[m]	[kN]	[kN.m]
1	0.00	0.00	0.00
2	0.50	-0.67	0.11
3	0.99	-2.61	0.86
4	1.00	-2.67	0.89
5	1.01	-2.72	0.92
6	1.50	-6.00	3.00
7	1.99	-10.56	7.01
8	2.00	-10.67	7.11
9	2.01	-10.76	7.22
10	2.50	-15.62	13.64
11	3.00	-21.79	22.94
12	3.50	-29.17	35.63
13	4.00	-37.78	52.31
14	4.50	-47.60	73.60
15	4.99	-58.41	99.53
16	5.00	-58.15	100.11
17	5.01	-57.41	100.69
18	5.50	-21.06	119.92
19	5.79	0.45	122.91
20	6.00	16.03	121.18
21	6.50	53.12	103.89
22	7.00	90.21	68.06
23	7.50	127.30	13.68
24	7.61	135.46	-0.77

---

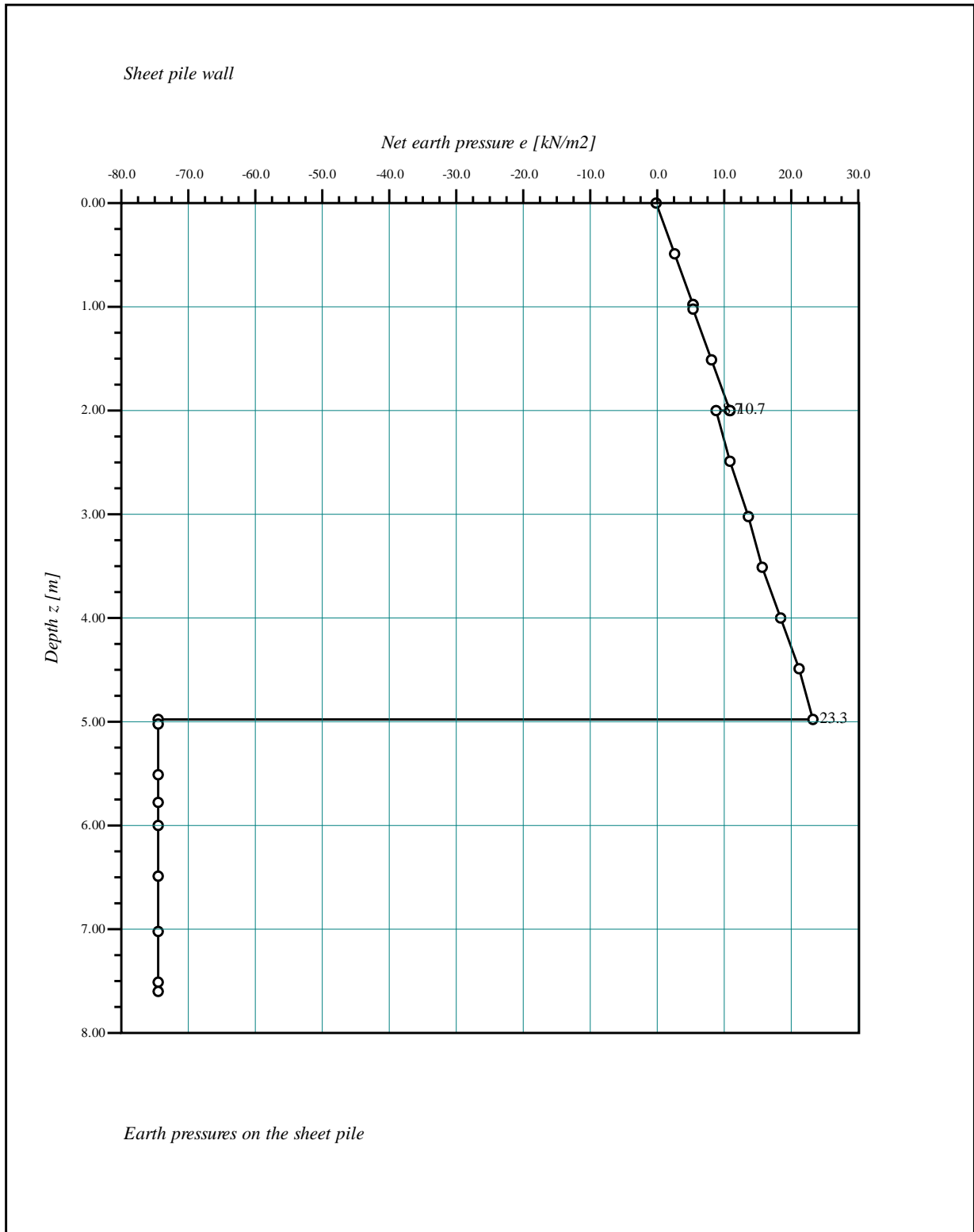

<p><b>GEOTEC Software Inc</b>                  PO Box 14001 Richmond Road PO, Calgary AB, Canada T3E 7Y7</p>	
<p><b>Scale: 688</b>  <b>File: Ex04</b>  <b>Page No.:</b></p>	<p><b>Project: Examples to verify sheet pile wall</b>  <b>Date: 02-11-2021</b>  <b>Title: Cantilever sheet pile penetrating in clay</b></p>

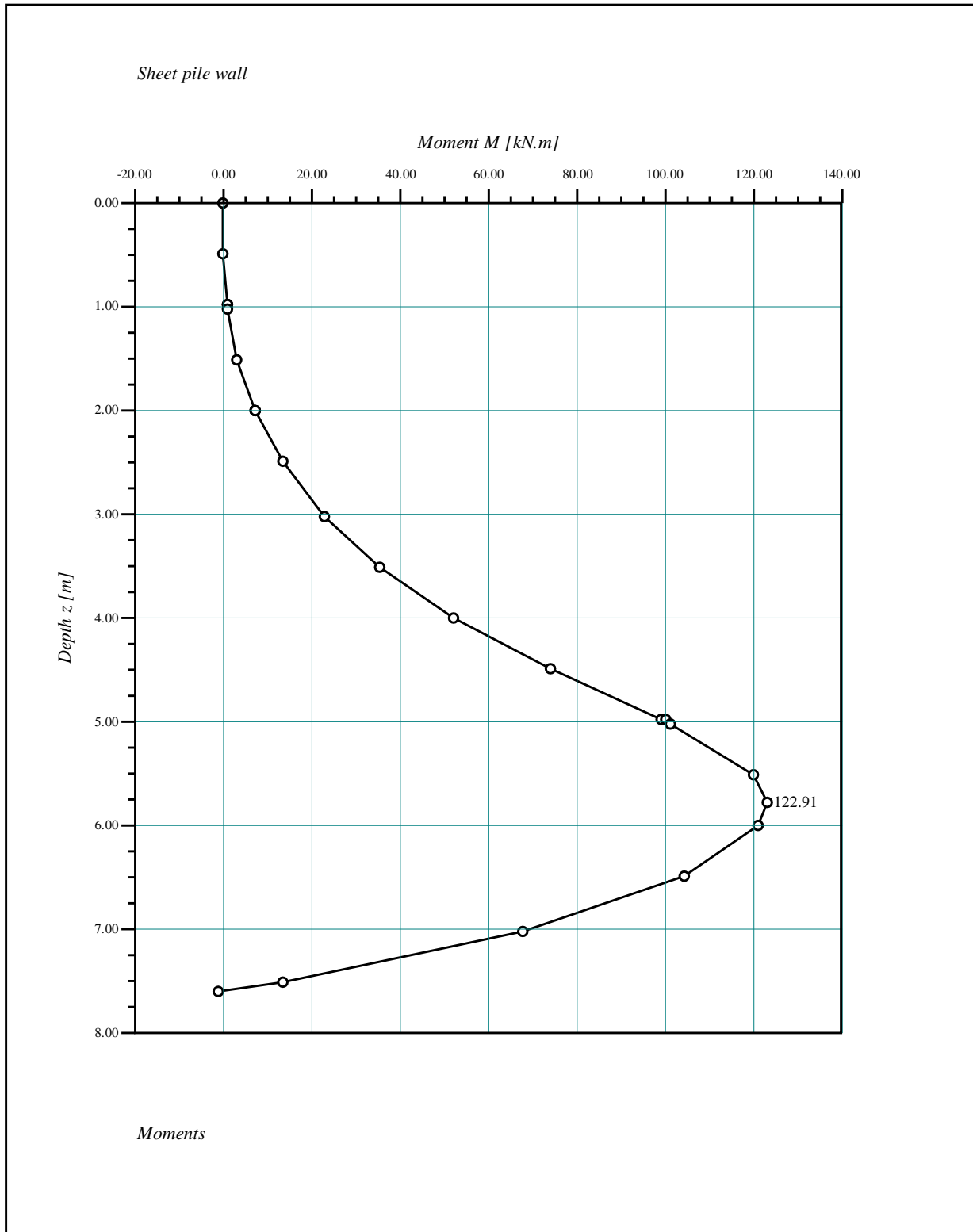

<p><b>GEOTEC Software Inc</b>                  PO Box 14001 Richmond Road PO, Calgary AB, Canada T3E 7Y7</p>	
<p><b>Scale: 1044</b>  <b>File: Ex04</b>  <b>Page No.:</b></p>	<p><b>Project: Examples to verify sheet pile wall</b>  <b>Date: 02-11-2021</b>  <b>Title: Cantilever sheet pile penetrating in clay</b></p>

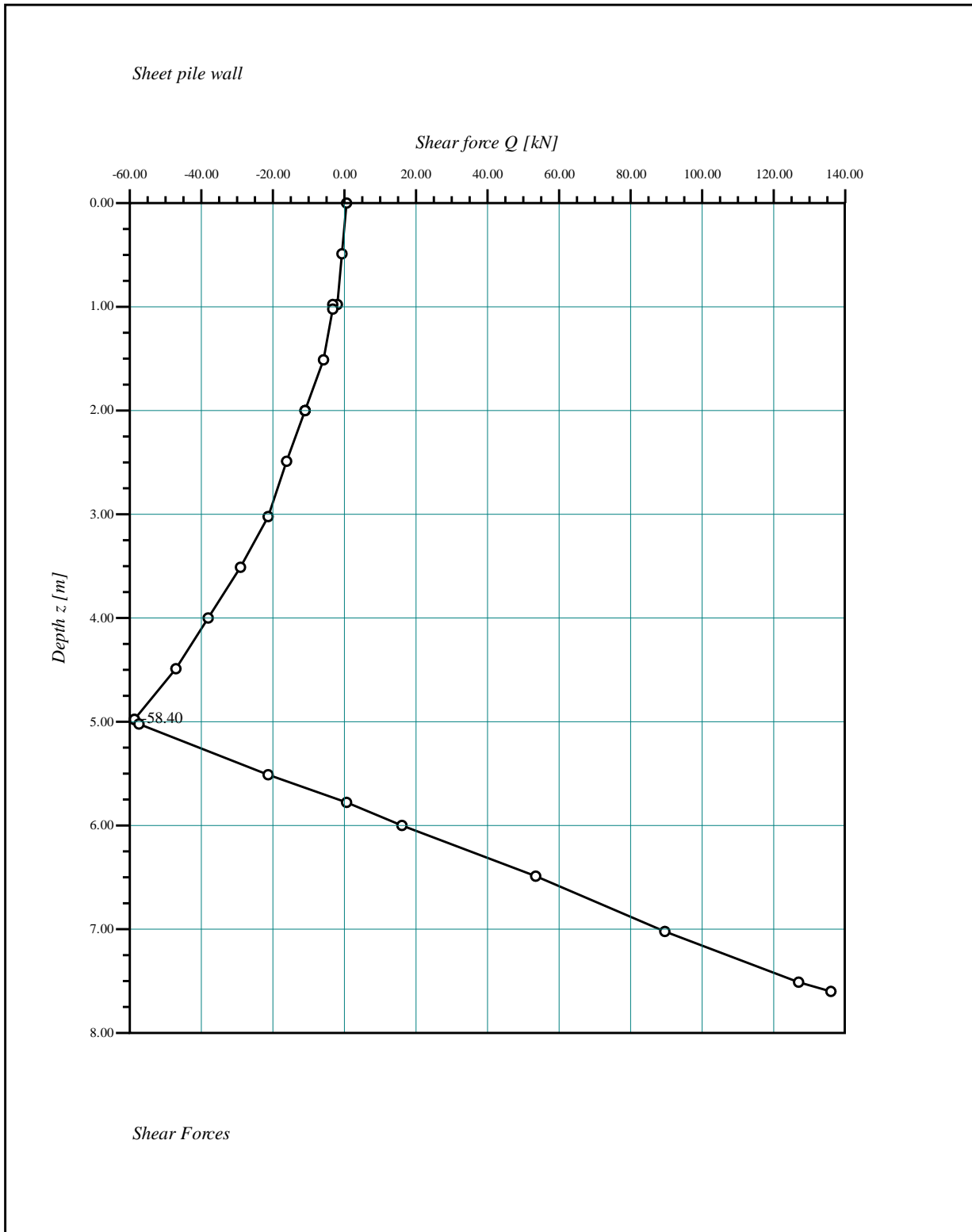

<b>GEOTEC Software Inc</b>	
<b>PO Box 14001 Richmond Road PO, Calgary AB, Canada T3E 7Y7</b>	
<b>Scale: 1289</b>	<b>Project: Examples to verify sheet pile wall</b>
<b>File: Ex04</b>	<b>Date: 02-11-2021</b>
<b>Page No.:</b>	<b>Title: Cantilever sheet pile penetrating in clay</b>

## 5.5.6 Example 5: Cantilever sheet pile penetrating in $c$ - $\phi$ soil

### 5.5.6.1 Description of the problem

To verify the analysis of cantilever sheet pile penetrating in  $c$ - $\phi$  soil, the theoretical penetration depth  $d$  for the given cantilever sheet pile penetrating in clay sandy in Figure 5.28 is obtained by hand calculation and compared with that obtained by *GEO Tools*. The sides of an excavation 5.0 [m] deep are to be supported by a cantilever sheet pile wall. The unit weight and shear parameters of the soil layers are shown in Figure 5.28.

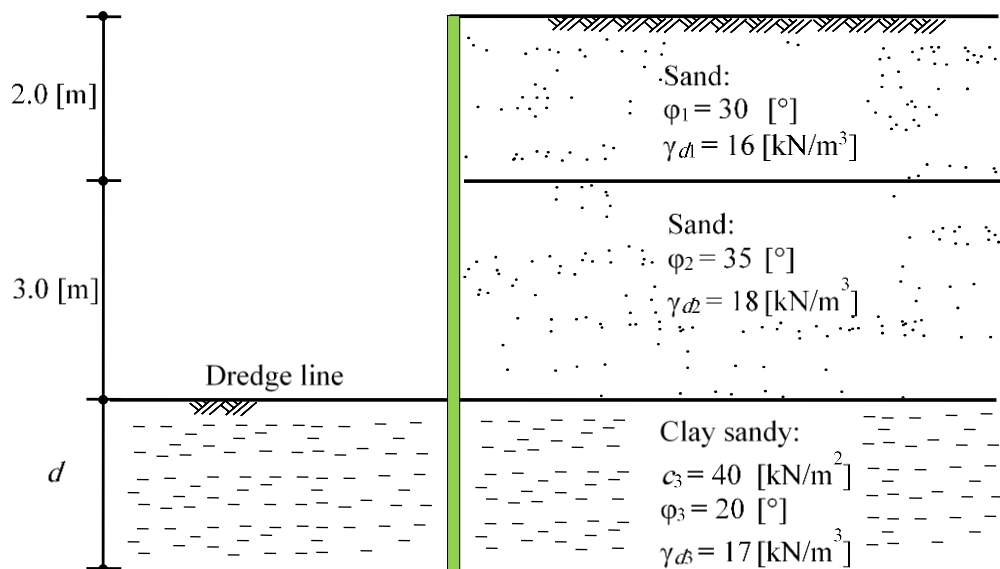

Figure 5.28 Cantilever sheet pile penetrating in clayey soil

### 5.5.6.2 Soil parameters and earth pressure coefficients

First layer:

$$\begin{aligned}\gamma_{d1} &= 16 && [\text{kN/m}^3] \\ \phi_1 &= 30 && [^\circ] \\ k_{a1} &= (1 - \sin \phi) / (1 + \sin \phi) = 0.33\end{aligned}$$

Second layer:

$$\begin{aligned}\gamma_{d2} &= 18 && [\text{kN/m}^3] \\ \phi_2 &= 35 && [^\circ] \\ k_{a2} &= (1 - \sin \phi) / (1 + \sin \phi) = 0.27\end{aligned}$$

Third layer:

$$\begin{aligned}\gamma_{d3} &= 17 && [\text{kN/m}^3] \\ \phi_3 &= 20 && [^\circ] \\ c_3 &= 40 && [\text{kN/m}^2] \\ k_{a3} &= (1 - \sin \phi) / (1 + \sin \phi) = 0.49 \\ k_{p3} &= 1 / k_{a3} = 2.04\end{aligned}$$

### 5.5.6.3 Determining earth pressures, forces and moments on the wall

The design dimensions and the earth pressure diagrams are shown in Figure 5.29 and Figure 5.30. The procedure is to equate moments about  $o$ , the point of application of the force representing the net passive resistance below the rotation point. Earth pressures on the pile wall are listed in Table 5.14. Forces, arms, and moments are listed in Table 5.15.

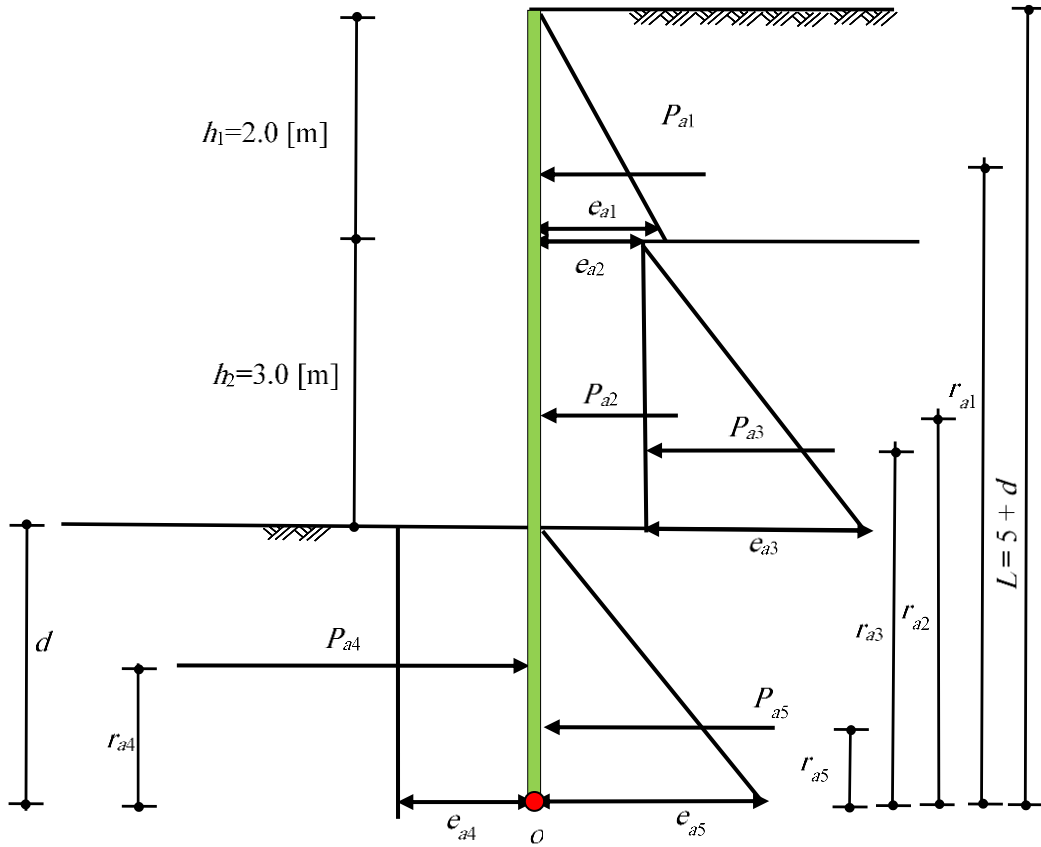

Figure 5.29 Active earth pressures diagrams

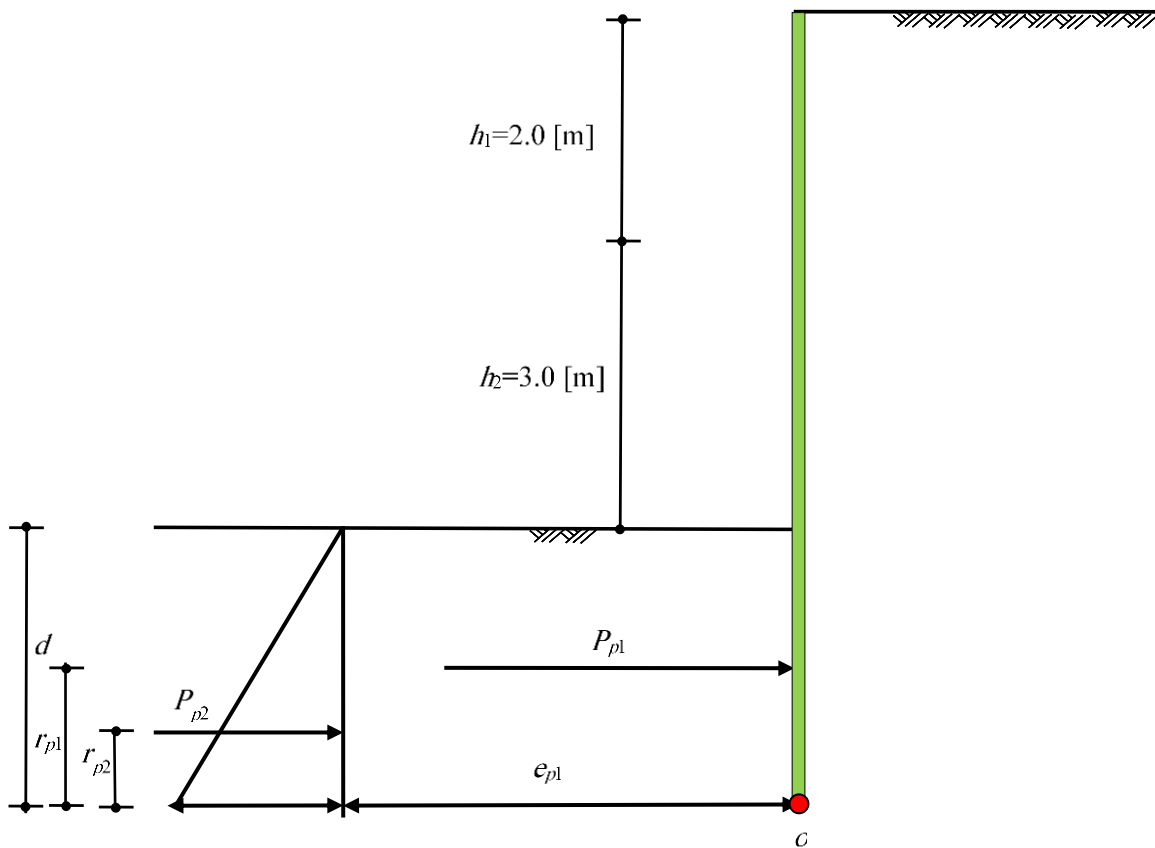

Figure 5.30 Passive earth pressures diagrams

Table 5.14 Earth pressures on the pile wall

Soil	Earth pressure $e$ [kN/m <sup>2</sup> ]		
Active	$e_{a1} = \gamma_{d1} h_1 k_{a1}$	$= 16 \times 2 \times 0.333$	$= 10.66$
	$e_{a2} = \gamma_{d1} h_1 k_{a2}$	$= 16 \times 2 \times 0.27$	$= 8.64$
	$e_{a3} = \gamma_{d2} h_2 k_{a2}$	$= 18 \times 3 \times 0.27$	$= 14.58$
	$e_{a4} = (\gamma_{d1} h_1 + \gamma_{d2} h_2) k_{a3} - 2c\sqrt{k_{a3}}$	$= (16 \times 2 + 18 \times 3) \times 0.49 - 2 \times 40 \sqrt{0.49}$	$= -13.86 \approx 0$ (neglected)
	$e_{a5} = \gamma_{d3} d k_{a3} + e_{a4}$	$= 17 \times d \times 0.49 - 13.86$	$= 8.33d - 13.86$
Passive	$e_{p1} = 2c\sqrt{k_{p3}}$	$= 2 \times 40 \sqrt{2.04}$	$= 114.26$
	$e_{p1} = \gamma_{d3} d k_{p3}$	$= 17 \times d \times 2.04$	$= 34.68 d$

Table 5.15 Earth forces on the pile wall and moments about point  $o$

Soil	Force $P$ [kN]	Arm from $o$ $r$ [m]	Moment @ $o$ $M = P \times r$ [kN.m]
Active	$P_{a1} = 0.5 e_{a1} h_1 = 10.66$	$3.67 + d$	$M_{a1} = 10.66 d + 39.12$
	$P_{a2} = e_{a2} h_2 = 25.92$	$1.5 + d$	$M_{a2} = 25.92 d + 38.88$
	$P_{a3} = 0.5 e_{a3} h_2 = 21.87$	$1 + d$	$M_{a3} = 21.87 d + 21.87$
	$P_{a4}$ (neglect negative value)	$d / 2$	$M_{a4} = 0$
	$P_{a5} = 0.5 e_{a5} d = 4.17 d^2 - 6.93 d$	$d / 3$	$M_{a4} = 1.39 d^3 - 2.31 d^2$
$P_{at} = \Sigma P_a = 58.45 - 6.93 d + 4.17 d^2$			$M_{at} = \Sigma M_a = 1.39 d^3 - 2.31 d^2 + 58.45 d + 99.87$
Passive	$P_{p1} = e_{p1} d = 114.26 d$	$d / 2$	$M_{p1} = 57.13 d^2$
	$P_{p2} = 0.5 e_{p2} d = 17.34 d^2$	$d / 3$	$M_{p2} = 5.78 d^3$
	$P_{pt} = \Sigma P_p = 114.26 d + 17.34 d^2$		

**5.5.6.4 Determining penetration depth and pile length**

Equating active and passive moments about  $o$ ,  $M_{at} = M_{pt}$

$$1.39 d^3 - 2.31 d^2 + 58.45 d + 99.87 = 5.78 d^3 + 57.13 d^2$$

or

$$4.39 d^3 + 59.44 d^2 - 58.45 d - 99.87 = 0$$



Solving the above equation gives:

$$d = 1.73 \text{ [m]}$$

$$\text{Pile wall length } L = h_1 + h_2 + d = 2 + 3 + 1.73 = 6.73 \text{ [m]}$$

Figure 5.31 shows net earth pressure diagram.

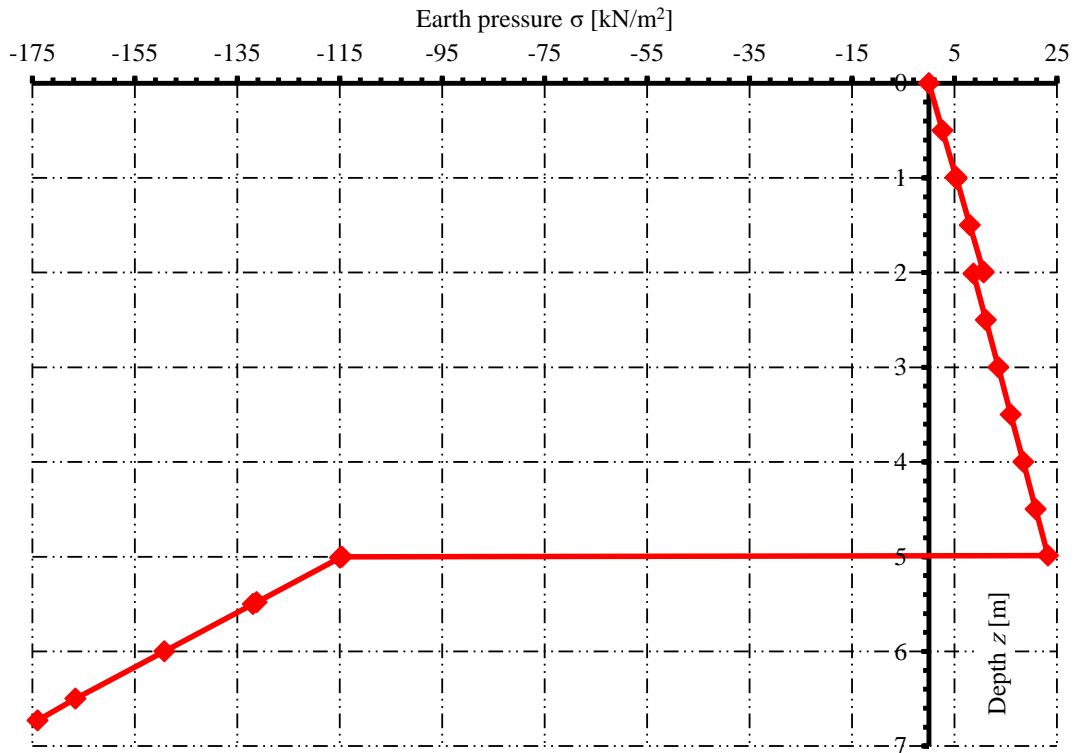

Figure 5.31 Net earth pressures diagram

### 5.5.6.5 Design of sheet pile wall

#### 5.5.6.5.1 Point of zero shear

Point of zero shear is determined from equating active and passive forces  $P_a(y) = P_p(y)$  at distance  $y$  below the dredge line.

$$58.45 - 6.93 y + 4.17 y^2 = 114.26 y + 17.34 y^2$$

$$13.17 y^2 + 121.19 y - 58.45 = 0$$

Or

$$y^2 + 9.2 y - 4.44 = 0$$

Solving the above equation, gives the point of zero shear at distance  $y$  as:

$$y = \frac{-9.2 \pm \sqrt{9.2^2 + 4 \times 4.44}}{2} = 0.46 \text{ [m]}$$

$$\text{Moment arm from the ground surface} = h_1 + h_2 + d = 2 + 3 + 0.46 = 5.46 \text{ [m]}$$

### 5.5.6.5.2 Max. Moment

Maximum moment on the wall is calculated in Table 5.16.

Table 5.16 Determining maximum moment  $M_{max}$

Soil	Moment $M = P \times r$ [kN.m]
Active	$M_{at} = 1.39 y^3 - 2.31 y^2 + 58.45 y + 99.87 = 125.83$
Passive	$M_{pt} = 5.78 y^3 + 57.13 y^2 = 12.65$
	$M_{max} = M_{at} - M_{pt} = 113.18$

### 5.5.6.6 Penetration depth by GEO Tools

The penetration depth obtained by *GEO Tools* for the cantilever sheet pile penetrating in  $c$ - $\phi$  soil is equal to that obtained by hand calculation. The input data and results of *GEO Tools* for this example are presented on the next pages.

# Sheet Pile Wall

\*\*\*\*\*

GEO Tools  
Version 12.2

Program authors Prof. M. El Gendy/ Dr. A. El Gendy

\*\*\*\*\*

Title: Cantilever sheet pile penetrating in clay sandy

Date: 02-11-2021

Project: Examples to verify sheet pile wall

File: Ex05 Cantilever in c- fhi soil

-----  
Cantilever sheet pile wall  
-----

## Data:

Distributed load	q	[kN/m <sup>2</sup> ]	= 0.00
Safety factor for passive resistance	Fs1	[-]	= 1.00
Safety factor for penetration depth	Fs2	[-]	= 1.00
Depth of dredge line	L1	[m]	= 5.00

## Soil Data:

Ground water depth-left	Gwl_L	[m]	= 10.00
Ground water depth-right	Gwl_R	[m]	= 10.00

## Layer No.: 1

Cohesion of the soil	C	[kN/m <sup>2</sup> ]	= 0.000
Angle of internal friction	φ	[°]	= 30.00
Dry unit weight of the soil-left	γ <sub>d_L</sub>	[kN/m <sup>3</sup> ]	= 16.00
Saturated unit weight of the soil-left	γ <sub>sat_L</sub>	[kN/m <sup>3</sup> ]	= 16.00
Dry unit weight of the soil-right	γ <sub>d_R</sub>	[kN/m <sup>3</sup> ]	= 16.00
Saturated unit weight of the soil-right	γ <sub>sat_R</sub>	[kN/m <sup>3</sup> ]	= 16.00
Layer thickness	h	[m]	= 2.00

## Layer No.: 2

Cohesion of the soil	C	[kN/m <sup>2</sup> ]	= 0.000
Angle of internal friction	φ	[°]	= 35.00
Dry unit weight of the soil-left	γ <sub>d_L</sub>	[kN/m <sup>3</sup> ]	= 18.00
Saturated unit weight of the soil-left	γ <sub>sat_L</sub>	[kN/m <sup>3</sup> ]	= 18.00
Dry unit weight of the soil-right	γ <sub>d_R</sub>	[kN/m <sup>3</sup> ]	= 18.00
Saturated unit weight of the soil-right	γ <sub>sat_R</sub>	[kN/m <sup>3</sup> ]	= 18.00
Layer thickness	h	[m]	= 3.00

## Layer No.: 3

Cohesion of the soil	C	[kN/m <sup>2</sup> ]	= 40.000
Angle of internal friction	φ	[°]	= 20.00
Dry unit weight of the soil-left	γ <sub>d_L</sub>	[kN/m <sup>3</sup> ]	= 17.00
Saturated unit weight of the soil-left	γ <sub>sat_L</sub>	[kN/m <sup>3</sup> ]	= 17.00
Dry unit weight of the soil-right	γ <sub>d_R</sub>	[kN/m <sup>3</sup> ]	= 17.00
Saturated unit weight of the soil-right	γ <sub>sat_R</sub>	[kN/m <sup>3</sup> ]	= 17.00
Layer thickness	h	[m]	= 5.00

## Result:

Sheet pile length	L	[m]	= 6.73
Minimum sheet pile length	L <sub>m</sub>	[m]	= 6.73
Minimum penetration depth	L <sub>2</sub>	[m]	= 1.73
Resistance force at the toe	R	[kN]	= 192.2
Maximum moment	M <sub>max</sub>	[kN.m]	= 114.09
Moment arm from the ground surface	Y	[m]	= 5.48

Earth pressures on the sheet pile:

No.	Depth	Passive earth pressure from soil weight	Active earth pressure from soil weight	Earth pressure
I	z	ep	ea	E
[-]	[m]	[kN/m <sup>2</sup> ]	[kN/m <sup>2</sup> ]	[kN/m <sup>2</sup> ]
1	0.00	0.00	0.00	0.00
2	0.50	0.00	2.67	2.67
3	0.99	0.00	5.28	5.28
4	1.00	0.00	5.33	5.33
5	1.01	0.00	5.39	5.39
6	1.50	0.00	8.00	8.00
7	1.99	0.00	10.61	10.61
8	2.00	0.00	10.67	10.67
9	2.01	0.00	8.72	8.72
10	2.50	0.00	11.11	11.11
11	3.00	0.00	13.55	13.55
12	3.50	0.00	15.99	15.99
13	4.00	0.00	18.43	18.43
14	4.50	0.00	20.87	20.87
15	4.99	0.00	23.26	23.26
16	5.00	-114.60	-13.86	-114.60
17	5.01	-114.95	-13.77	-114.95
18	5.48	-131.24	-9.86	-131.24
19	5.50	-131.94	-9.69	-131.94
20	6.00	-149.27	-5.52	-149.27
21	6.50	-166.61	-1.35	-166.61
22	6.73	-174.58	0.56	-174.02

Shear Forces/ Moments:

No.	Depth	Shear force	Moment
I	z	Q	M
	[m]	[kN]	[kN.m]
1	0.00	0.00	0.00
2	0.50	-0.67	0.11
3	0.99	-2.61	0.86
4	1.00	-2.67	0.89
5	1.01	-2.72	0.92
6	1.50	-6.00	3.00
7	1.99	-10.56	7.01
8	2.00	-10.67	7.11
9	2.01	-10.76	7.22
10	2.50	-15.62	13.64
11	3.00	-21.79	22.94
12	3.50	-29.17	35.63
13	4.00	-37.78	52.31
14	4.50	-47.60	73.60
15	4.99	-58.41	99.53
16	5.00	-57.95	100.11
17	5.01	-56.80	100.68
18	5.48	1.05	114.09
19	5.50	3.68	114.04
20	6.00	73.98	94.98
21	6.50	152.95	38.61
22	6.73	192.17	-1.04

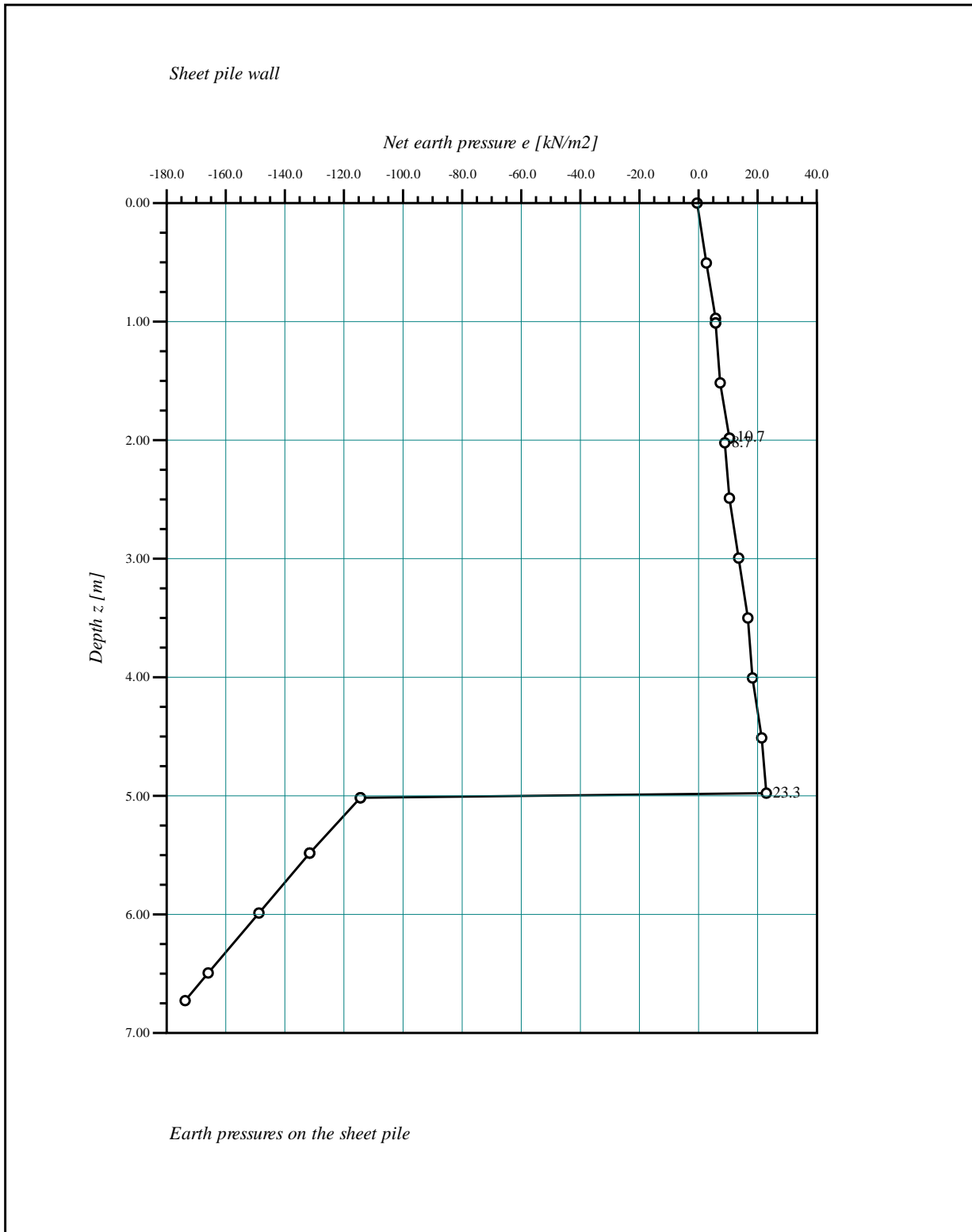

<b>GEOTEC Software Inc</b>	
PO Box 14001 Richmond Road PO, Calgary AB, Canada T3E 7Y7	
Scale: 1561	Project: Examples to verify sheet pile wall
File: Ex05	Date: 02-11-2021
Page No.:	Title: Cantilever sheet pile penetrating in clay sandy

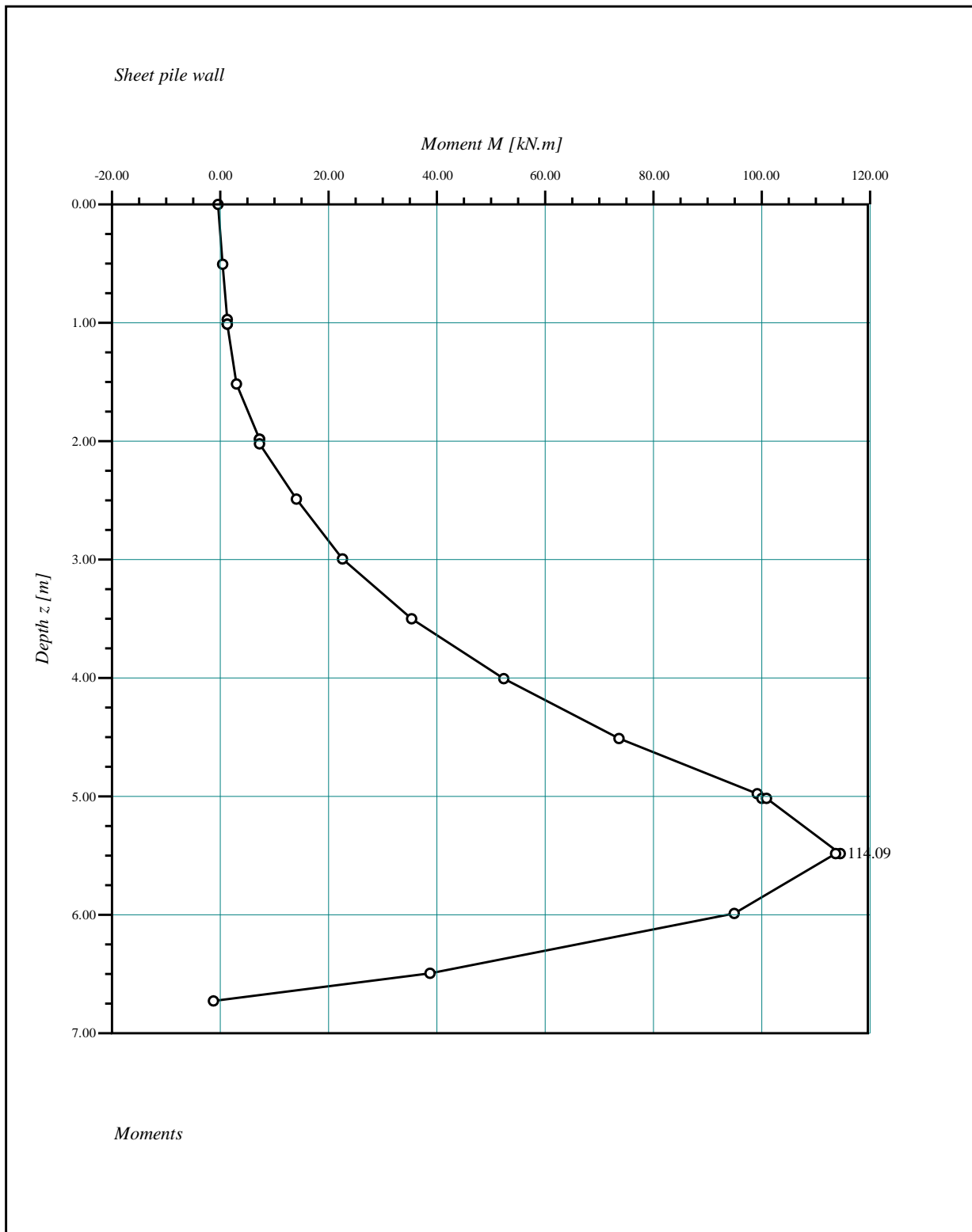

<p><b>GEOTEC Software Inc</b>                  PO Box 14001 Richmond Road PO, Calgary AB, Canada T3E 7Y7</p>	
<p>Scale: 851                  File: Ex05                  Page No.:</p>	<p>Project: Examples to verify sheet pile wall                  Date: 02-11-2021                  Title: Cantilever sheet pile penetrating in clay sandy</p>

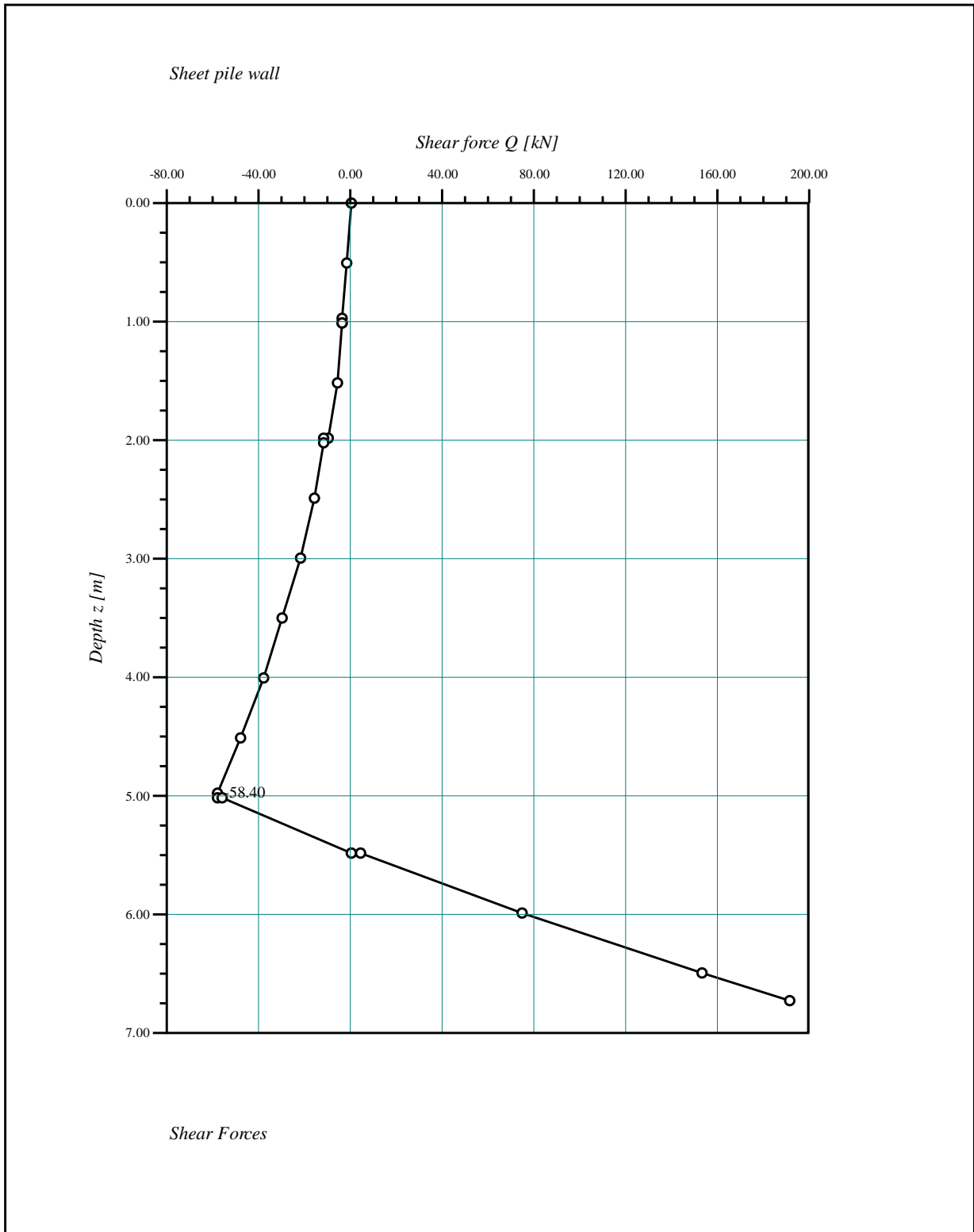

<p><b>GEOTEC Software Inc</b>                  PO Box 14001 Richmond Road PO, Calgary AB, Canada T3E 7Y7</p>	
<p><b>Scale:</b> 2011  <b>File:</b> Ex05  <b>Page No.:</b></p>	<p><b>Project:</b> Examples to verify sheet pile wall  <b>Date:</b> 02-11-2021  <b>Title:</b> Cantilever sheet pile penetrating in clay sandy</p>

## 5.5.7 Example 6: Design a cantilever sheet pile wall

### 5.5.7.1 Description of the problem

It is required to design retaining pile walls for a building of 28.3 [m] × 21.2 [m] area, Figure 5.32. The building consists of a basement and five typical floors. The expected live load around the building is 20 [kN/m<sup>2</sup>] at a depth of 1.7 [m] under the ground surface. The depth of foundation is 3.8 [m] under the ground surface. Groundwater depth is 1.0 [m] under the ground surface, as shown in Figure 5.33.

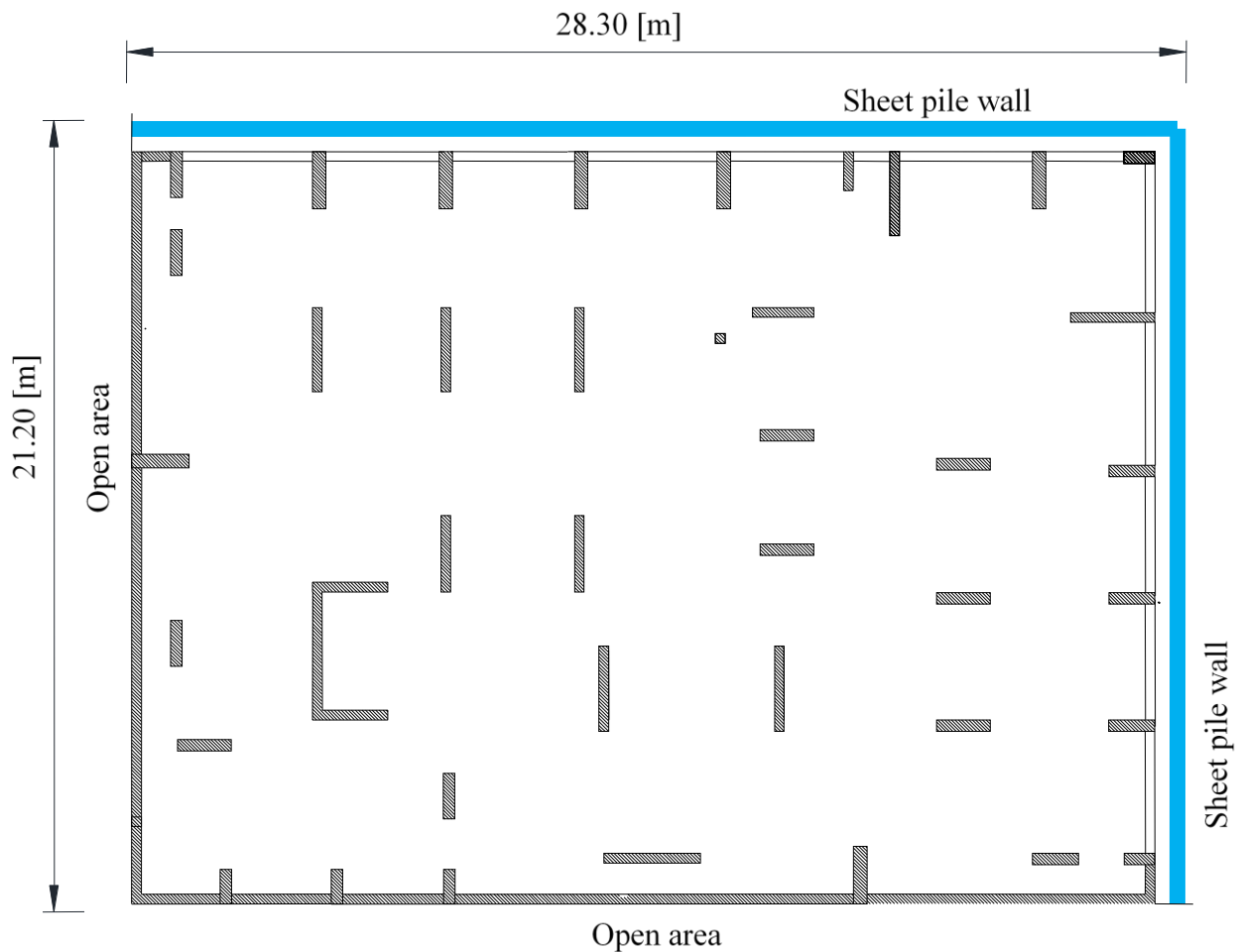

Figure 5.32 General layout of the project and the adjacent areas

### 5.5.7.1 Soil parameters and earth pressure coefficients

Dry unit weight of the soil	$\gamma_d$	= 18 [kN/m <sup>3</sup> ]
Saturated unit weight of the soil	$\gamma_{sat}$	= 21 [kN/m <sup>3</sup> ]
Submerged unit weight of the soil	$\gamma_{Sub}$	= 21 - 9.81 = 11.19 [kN/m <sup>3</sup> ]
Angle of internal friction of the soil	$\phi$	= 30 [°]

Active earth pressure coefficient	$k_a$	= (1 - sin $\phi$ ) / (1 + sin $\phi$ ) = 1/3
Passive earth pressure coefficient	$k_p$	= (1 + sin $\phi$ ) / (1 - sin $\phi$ ) = 3

### 5.5.7.2 Levels

Foundation depth for neighbor areas  $d_f = 1.7$  [m]

Due to the dewatering, the water table is assumed to be at the bedroom level for all sides of the pile wall, WT = 3.8 [m]. The thickness of the sand layer is 10 [m].



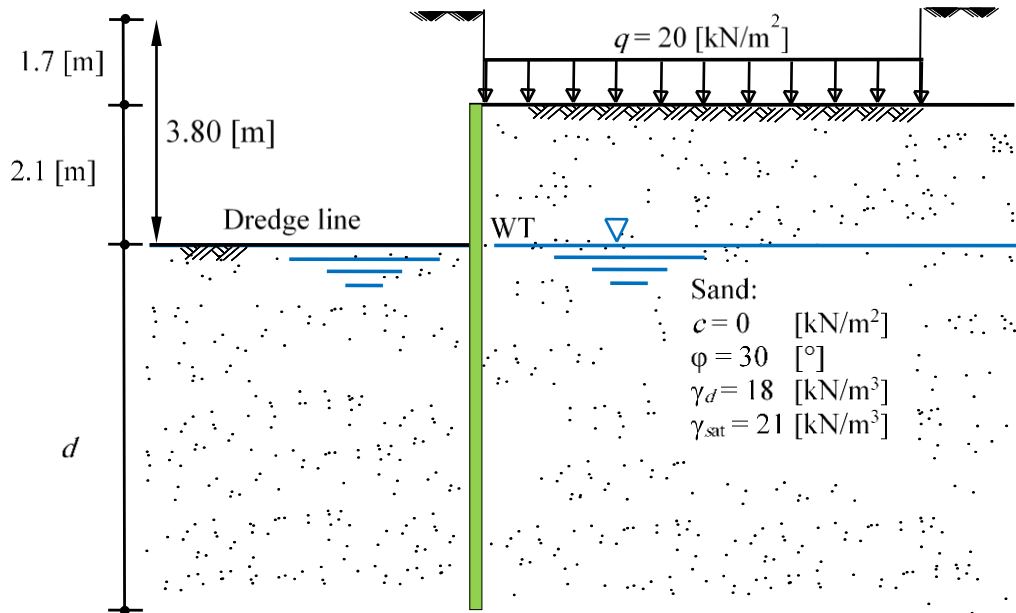

Figure 5.33 Cantilever sheet pile in sand

**5.5.7.3 Determining earth pressures, forces and moments on the wall**

The design dimensions and the earth pressure diagrams are shown in Figure 5.34. The procedure is to equate moments about *o*, the point of application of the force representing the net passive resistance below the rotation point. Earth pressures on the pile wall are listed in Table 5.17. Forces, arms, and moments are listed in Table 5.18. The distributions of hydrostatic pressure on the two sides of the wall balance and can be eliminated from the calculations.

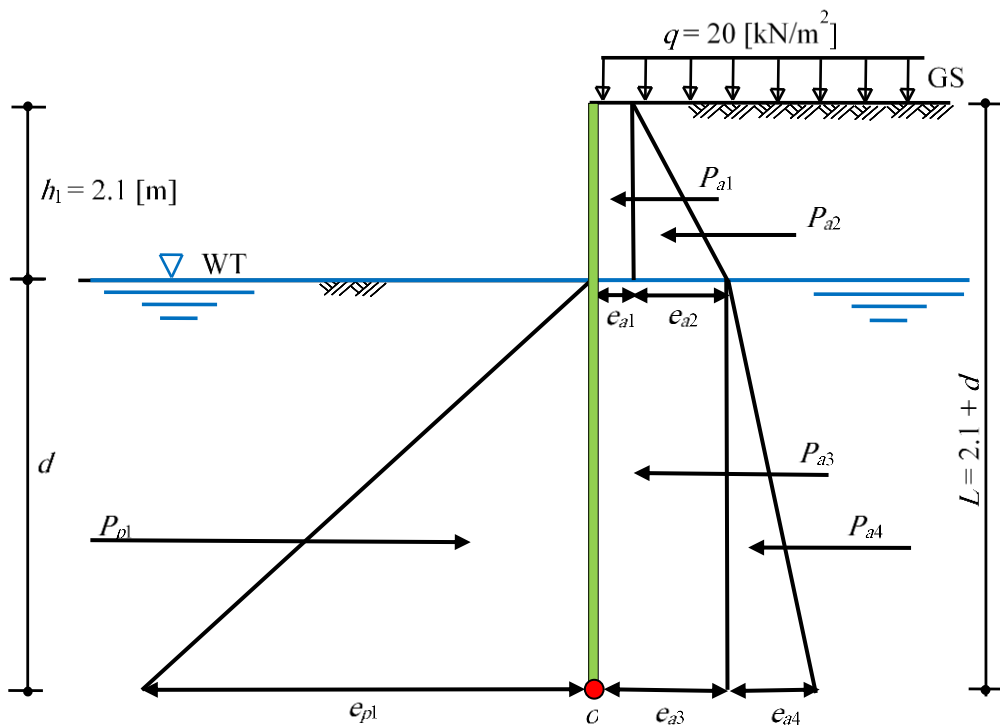

Figure 5.34 Earth pressures diagrams

Table 5.17 Earth pressures on the pile wall

Soil	Earth pressure $e$ [kN/m <sup>2</sup> ]		
Active	$e_{a1} = q k_a$	$= 20 \times 0.33$	$= 6.67$
	$e_{a2} = \gamma_s h_1 k_a$	$= 18 \times 2.1 \times 0.33$	$= 12.60$
	$e_{a3} = e_{a1} + e_{a2}$	$= 6.67 + 12.6$	$= 19.27$
	$e_{a4} = \gamma_{sub} d k_a$	$= 11.19 \times d \times 0.33$	$= 3.73 d$
Passive	$e_{p1} = \gamma_{sub} d k_p$	$= 11.19 \times d \times 3$	$= 33.57 d$

Table 5.18 Earth forces on the pile wall and moments about point  $o$ 

Soil	Force $P$ [kN]	Arm from $o$ $r$ [m]	Moment @ $o$ $M = P \times r$ [kN.m]
Active	$P_{a1} = e_{a1} h_1 = 14$	$1.05 + d$	$M_{a1} = 14 d + 14.7$
	$P_{a2} = 0.5 e_{a2} h_1 = 13.23$	$0.7 + d$	$M_{a2} = 13.23 d + 9.26$
	$P_{a3} = e_{a3} d = 19.27 d$	$d/2$	$M_{a3} = 9.64 d^2$
	$P_{a4} = 0.5 e_{a4} d = 1.87 d^2$	$d/3$	$M_{a4} = 0.62 d^3$
	$P_{at} = \Sigma P_a = 1.87 d^2 + 19.27 d + 27.23$		
Passive	$P_{p1} = 0.5 e_{p1} d = 16.79 d^2$	$d/3$	$M_{p1} = 5.6 d^3$

#### 5.5.7.4 Determining penetration depth and pile length

Equating active and passive moments about  $o$ ,  $M_{at} = M_{pt}$

$$0.62 d^3 + 9.64 d^2 + 27.23 d + 23.96 = 5.6 d^3$$

or

$$4.98 d^3 + 9.64 d^2 - 27.23 d - 23.96 = 0$$

Solving the above equation gives:

$$\text{Penetration depth} = d = 3.74 \text{ [m]}$$

Factor of safety for penetration depth = 20%. Therefore, the penetration depth with an additional 20% is:

$$\text{Penetration depth } d_p = 1.2 \times d = 1.2 \times 3.74 = 4.49 \text{ [m]}$$

$$\text{Pile wall length } L = h_1 + d_p = 2.1 + 4.49 = 6.59 \text{ [m]}$$

Take  $L = 7.0$  [m]

Figure 5.35 shows earth pressure diagrams in a single view.

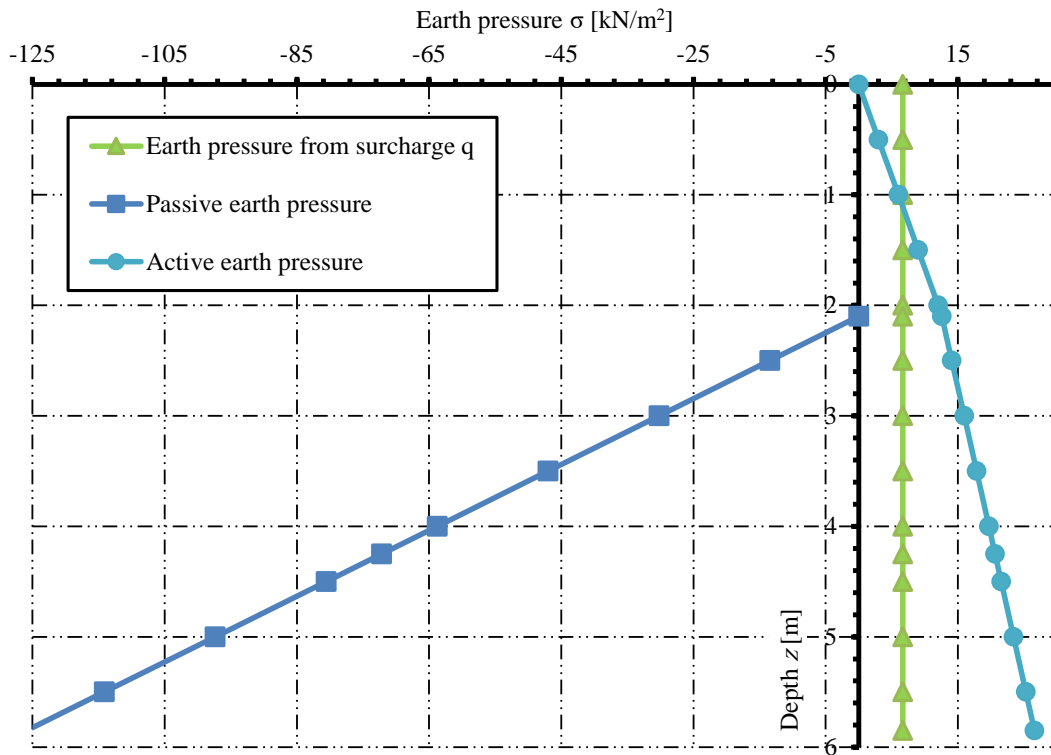

Figure 5.35 Earth pressures diagrams

### 5.5.7.5 Design of sheet pile wall

#### 5.5.7.5.1 Point of zero shear

Point of zero shear is determined from equating active and passive forces  $P_a(y) = P_p(y)$  at distance  $y$  below the water table.

$$1.87 y^2 + 19.27 y + 27.23 = 16.79 y^2$$

or

$$y^2 - 1.29 y - 1.83 = 0$$

Solving the above equation, gives the point of zero shear at distance  $y$  as:

$$y = \frac{1.29 \pm \sqrt{1.29^2 + 4 \times 1.83}}{2} = 2.14 \text{ [m]}$$

Moment arm from the ground surface = 4.24 [m]

### 5.5.7.5.2 Max. Moment

Maximum moment on the wall is calculated in Table 5.19.

Table 5.19 Determining maximum moment  $M_{max}$

Soil	Moment $M = P \times r$ [kN.m]
Active	$M_{at} = 0.62 y^3 + 9.64 y^2 + 27.23 y + 23.96 = 132.46$
Passive	$M_{pt} = 5.6 y^3 = 54.88$
	$M_{max} = M_{at} - M_{pt} = 77.58$

### 5.5.7.5.3 Design of section according to ECP

Take pile diameter = 30 [cm] diameter and  $A_s$  not less than 1.5% concrete section.

$$M_{max} \text{ per pile of diameter 30 cm} = 77.58 \times 30 / 100 = 23.27 \text{ [kN.m/m]}$$

$$A_s (\text{min}) = 0.015 \times 30^2 \pi / 4 = 10.6 \text{ [cm}^2\text{]}$$

$$k_1 = 0.30 / \sqrt{(23.27 \times 10^{-3} / 0.30)} = 1.08 \rightarrow k_2 = 179 \text{ (cover is small and is neglected)}$$

$$A_s = (23.27 \times 10^{-3}) / (179 \times 0.30) \times 10^4 = 4.51 \text{ [cm}^2\text{]}$$

$$\text{For double rft } A_s = 4.51 \times 2 = 9.02 \text{ [cm}^2\text{]}$$

$$\text{Take } A_s = 6 \phi 16 = 12.10 \text{ [cm}^2\text{]} \text{ (Even number)}$$

**5.5.7.5.4 Determining number of piles**

Total length of building sides to be supported by sheet pile walls =  $28.30 + 21.20 = 49.50$  [m].

Total required number of piles =  $49.50 / 0.3 = 165$  piles.

Figure 5.36 shows plan of the building with arrangement of piles.

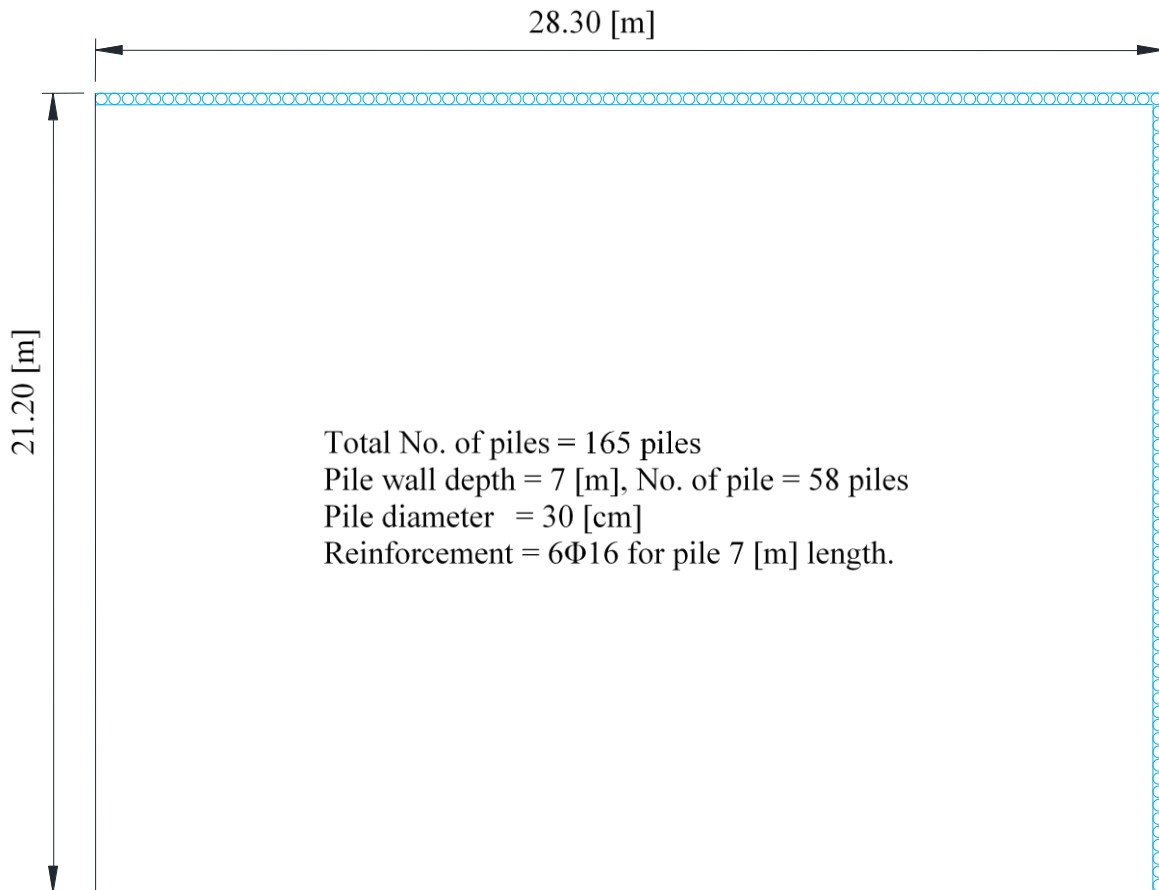

Figure 5.36 Plan of pile walls

**5.5.7.1 Penetration depth by GEO Tools**

The penetration depth obtained by *GEO Tools* for the cantilever sheet pile in the sand is equal to that obtained by hand calculation. The input data and results of *GEO Tools* for this example are presented on the next pages.

```

*****
                        GEO Tools
                        Version 12.2
Program authors Prof. M. El Gendy/ Dr. A. El Gendy
*****
Title: Design a cantilever sheet pile wall
Date: 15-11-2021
Project: Cantilever sheet pile wall
File: Ex06 Design a cantilever

```

```

-----
Cantilever sheet pile wall
-----

```

## Data:

Distributed load	q	[kN/m2]	= 20.00
Safety factor for passive resistance	Fs1	[-]	= 1.00
Safety factor for penetration depth	Fs2	[-]	= 1.20
Depth of dredge line	L1	[m]	= 2.10

## Soil Data:

Ground water depth-left	Gwl_L	[m]	= 2.10
Ground water depth-right	Gwl_R	[m]	= 2.10

## Layer No.: 1

Cohesion of the soil	C	[kN/m2]	= 0.000
Angle of internal friction	$\phi$	[°]	= 30.00
Dry unit weight of the soil-left	$\gamma_d_L$	[kN/m3]	= 18.00
Saturated unit weight of the soil-left	$\gamma_{sat\_L}$	[kN/m3]	= 21.00
Dry unit weight of the soil-right	$\gamma_d_R$	[kN/m3]	= 18.00
Saturated unit weight of the soil-right	$\gamma_{sat\_R}$	[kN/m3]	= 21.00
Layer thickness	h	[m]	= 10.00

## Result:

Sheet pile length	L	[m]	= 6.60
Minimum sheet pile length	Lm	[m]	= 5.85
Minimum penetration depth	L2	[m]	= 3.75
Resistance force at the toe	R	[kN]	= 110.3
Maximum moment	Mmax	[kN.m]	= 77.61
Moment arm from the ground surface	Y	[m]	= 4.25

## Sheet Pile Wall

Earth pressures on the sheet pile:

No.	Depth	Passive earth pressure from soil weight	Water pressure left	Active earth pressure from surcharge	Active earth pressure from soil weight	Water pressure right	Earth pressure
I	z	ep	wl	eq	ea	wr	E
[-]	[m]	[kN/m <sup>2</sup> ]	[kN/m <sup>2</sup> ]	[kN/m <sup>2</sup> ]	[kN/m <sup>2</sup> ]	[kN/m <sup>2</sup> ]	[kN/m <sup>2</sup> ]
1	0.00	0.00	0.00	6.67	0.00	0.00	6.67
2	0.50	0.00	0.00	6.67	3.00	0.00	9.67
3	0.99	0.00	0.00	6.67	5.94	0.00	12.61
4	1.00	0.00	0.00	6.67	6.00	0.00	12.67
5	1.01	0.00	0.00	6.67	6.06	0.00	12.73
6	1.50	0.00	0.00	6.67	9.00	0.00	15.67
7	2.00	0.00	0.00	6.67	12.00	0.00	18.67
8	2.09	0.00	0.00	6.67	12.54	0.00	19.21
9	2.10	0.00	0.00	6.67	12.60	0.00	19.27
10	2.11	-0.34	-0.10	6.67	12.64	0.10	18.97
11	2.50	-13.43	-3.92	6.67	14.09	3.92	7.33
12	3.00	-30.21	-8.83	6.67	15.96	8.83	-7.59
13	3.50	-47.00	-13.73	6.67	17.82	13.73	-22.51
14	4.00	-63.78	-18.64	6.67	19.69	18.64	-37.43
15	4.25	-72.18	-21.09	6.67	20.62	21.09	-44.89
16	4.50	-80.57	-23.54	6.67	21.55	23.54	-52.35
17	5.00	-97.35	-28.45	6.67	23.42	28.45	-67.27
18	5.50	-114.14	-33.35	6.67	25.28	33.35	-82.19
19	5.85	-125.89	-36.79	6.67	26.59	36.79	-92.63

Shear Forces/ Moments:

No.	Depth	Shear force	Moment
I	z	Q	M
	[m]	[kN]	[kN.m]
1	0.00	0.00	0.00
2	0.50	-4.08	0.96
3	0.99	-9.54	4.24
4	1.00	-9.67	4.33
5	1.01	-9.79	4.43
6	1.50	-16.75	10.88
7	2.00	-25.33	21.33
8	2.09	-27.04	23.69
9	2.10	-27.23	23.96
10	2.11	-27.42	24.23
11	2.50	-32.55	36.08
12	3.00	-32.48	52.65
13	3.50	-24.96	67.32
14	4.00	-9.98	76.36
15	4.25	0.31	77.61
16	4.50	12.47	76.05
17	5.00	42.37	62.65
18	5.50	79.74	32.43
19	5.85	110.33	-0.72

Sheet pile wall

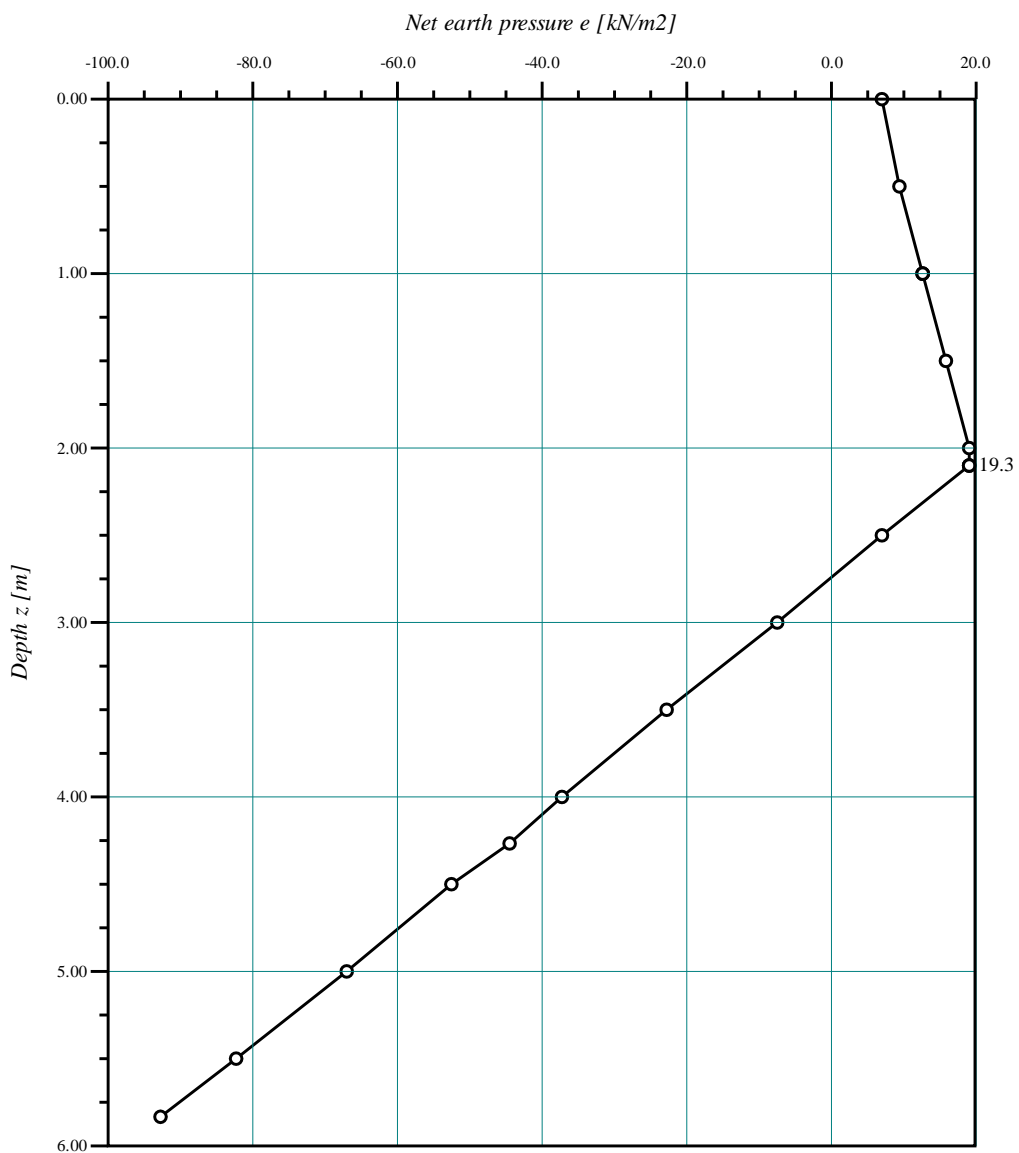

Earth pressures on the sheet pile

GEOTEC Software Inc

PO Box 14001 Richmond Road PO, Calgary AB, Canada T3E 7Y7

Scale: 804

File: Ex06

Page No.:

Project: Cantilever sheet pile wall

Date: 15-11-2021

Title: Design a cantilever sheet pile wall



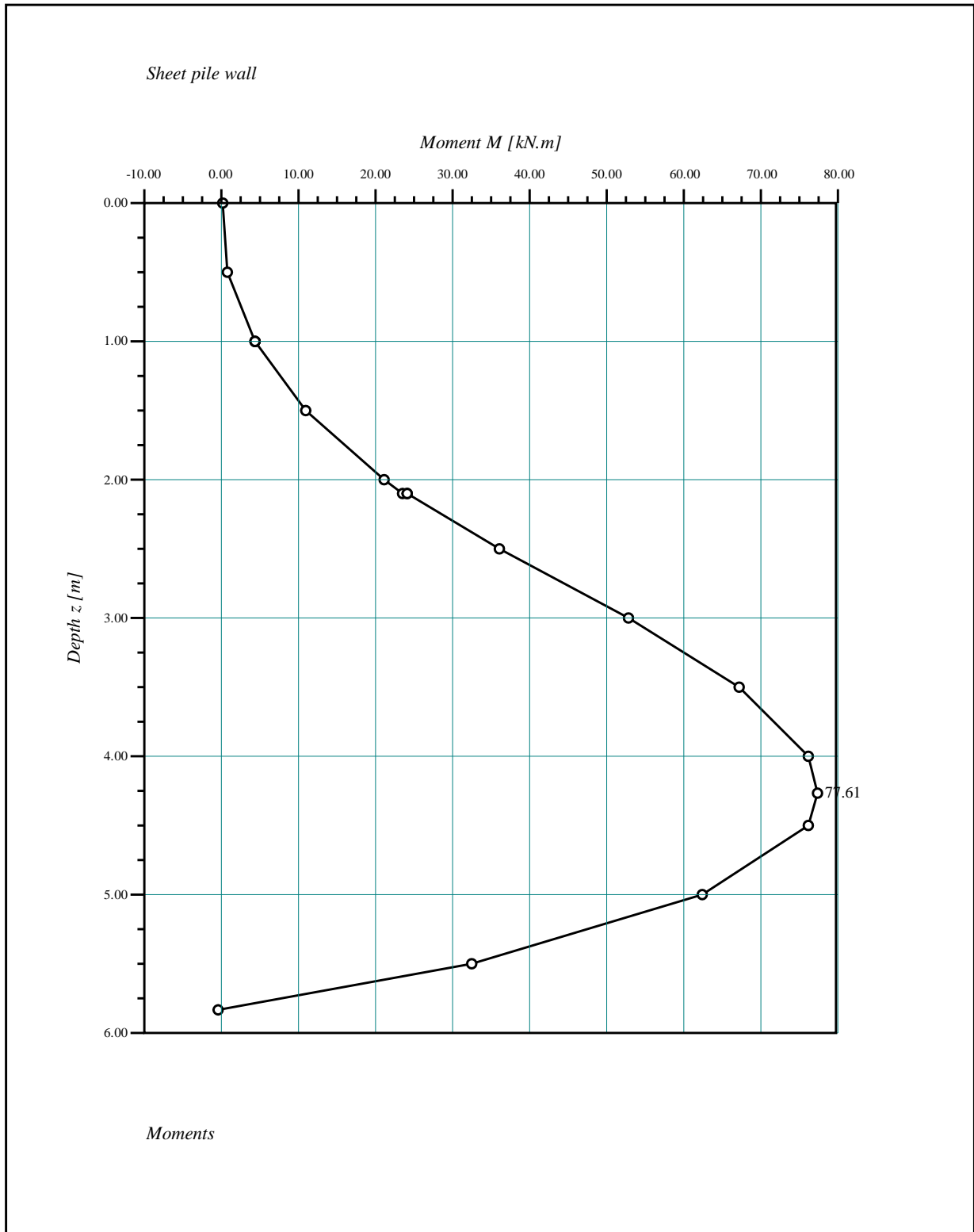

<p><b>GEOTEC Software Inc</b>                  PO Box 14001 Richmond Road PO, Calgary AB, Canada T3E 7Y7</p>	
<p><b>Scale:</b> 599  <b>File:</b> Ex06  <b>Page No.:</b></p>	<p><b>Project:</b> Cantilever sheet pile wall  <b>Date:</b> 15-11-2021  <b>Title:</b> Design a cantilever sheet pile wall</p>

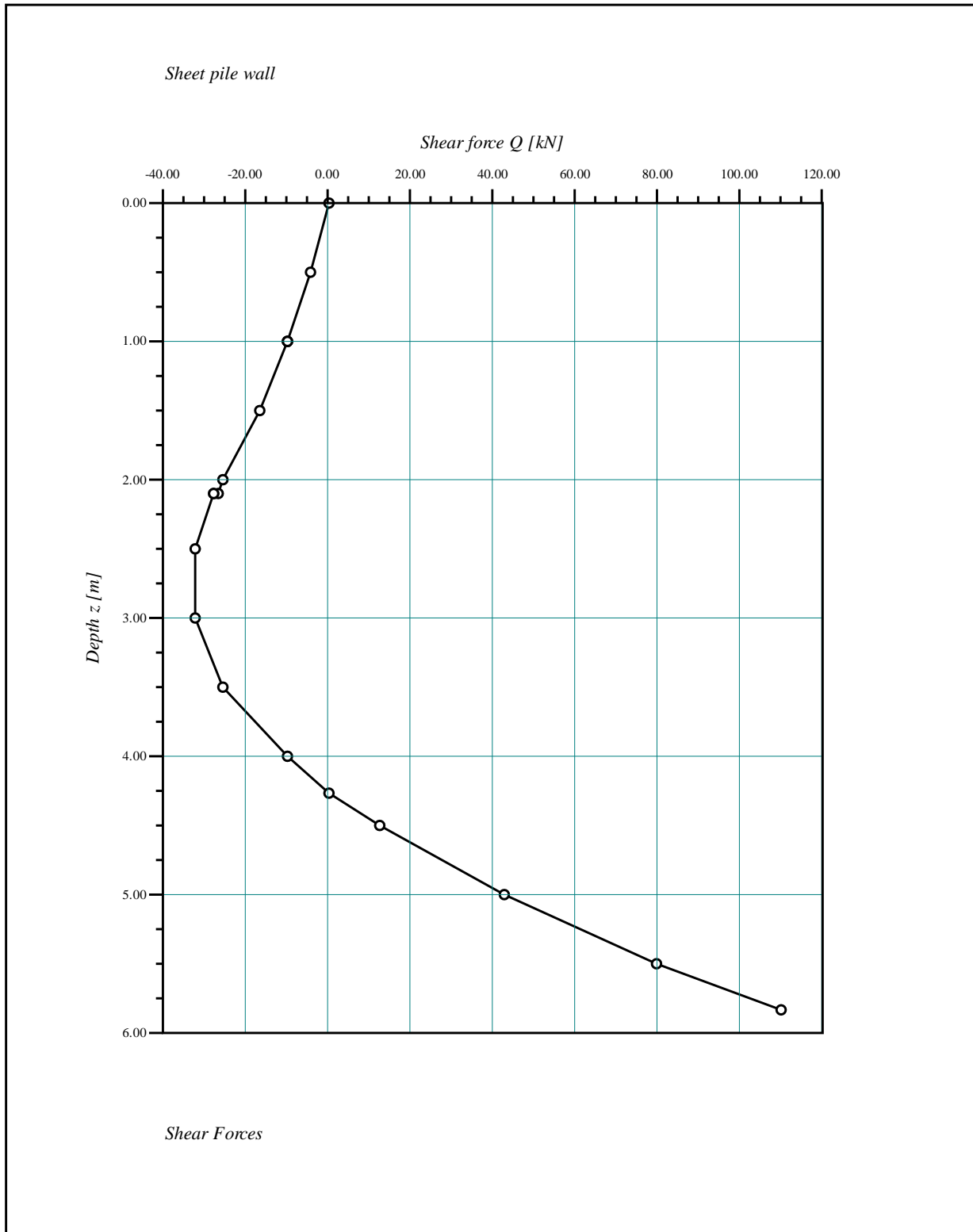

<b>GEOTEC Software Inc</b>	
<b>PO Box 14001 Richmond Road PO, Calgary AB, Canada T3E 7Y7</b>	
<b>Scale: 1120</b>	<b>Project: Cantilever sheet pile wall</b>
<b>File: Ex06</b>	<b>Date: 15-11-2021</b>
<b>Page No.:</b>	<b>Title: Design a cantilever sheet pile wall</b>

**5.5.8 Example 7: Anchored sheet pile penetrating in sand**

**5.5.8.1 Description of the problem**

To verify the analysis of an anchored sheet pile wall in the sand, the penetration depth  $d$  for the given anchored sheet pile wall in the sand in Figure 5.37 obtained by *Craig* (2012), Example (11.8) page 451, through hand calculation using free earth support method is compared with that obtained by *GEO Tools*. The side of an excavation 8.8 [m] deep in the sand is to be supported by an anchored sheet pile wall. The anchors are spaced at 2.0 [m] centers at a depth of 1.5 [m] from the surface. The water table is 6.4 [m] below the ground surface. The unit weight of the sand above the water table is  $\gamma_d = 17$  [kN/m<sup>3</sup>], and the saturated unit weight is  $\gamma_{sat} = 20$  [kN/m<sup>3</sup>] below the water table. Shear parameters are  $c = 0$  [kN/m<sup>2</sup>] and  $\phi = 38.5$  [°]. A surcharge of  $q = 10$  [kN/m<sup>2</sup>] is applied on the surface. Take a factor of safety for the passive earth pressure  $F_s = 1.2$  [-] and a factor of safety for penetration depth = 20%.

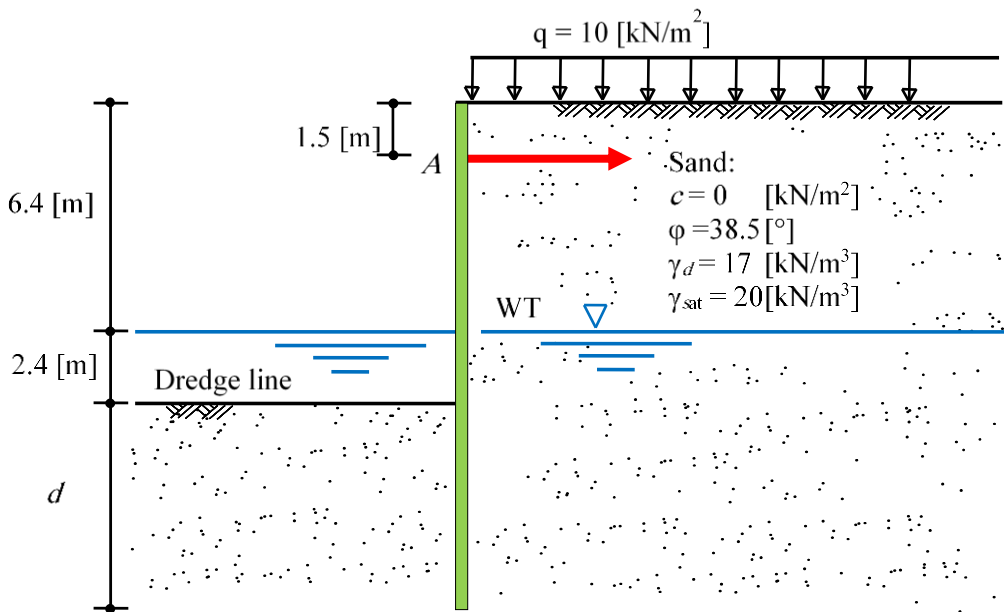

Figure 5.37 Anchored sheet pile in sand

**5.5.8.2 Soil parameters and earth pressure coefficients**

Dry unit weight of the soil	$\gamma_d$	= 17 [kN/m <sup>3</sup> ]
Saturated unit weight of the soil	$\gamma_{sat}$	= 20 [kN/m <sup>3</sup> ]
Submerged unit weight of the soil	$\gamma_{Sub}$	= 20 - 9.81 = 10.2 [kN/m <sup>3</sup> ]
Angle of internal friction	$\phi$	= 38.5 [°]
Active earth pressure coefficient	$k_a$	= $(1 - \sin \phi) / (1 + \sin \phi) = 0.23$
Passive earth pressure coefficient	$k_p$	= $(1 + \sin \phi) / (1 - \sin \phi) = 4.3$
	$k_p / F_s$	= 3.58

5.5.8.3 Determining earth pressures, forces and moments on the wall

The design dimensions and the earth pressure diagrams are shown in Figure 5.38. The procedure is to equate moments about A, the position of the anchor. Earth pressures on the pile wall are listed in Table 5.20. Forces, arms, and moments are listed in Table 5.21. Passive earth pressure is divided by the specified factor of safety  $F_s$ . The water levels on the two sides of the wall are equal. Therefore, the hydrostatic pressure distributions are in balance and can be eliminated from the calculations.

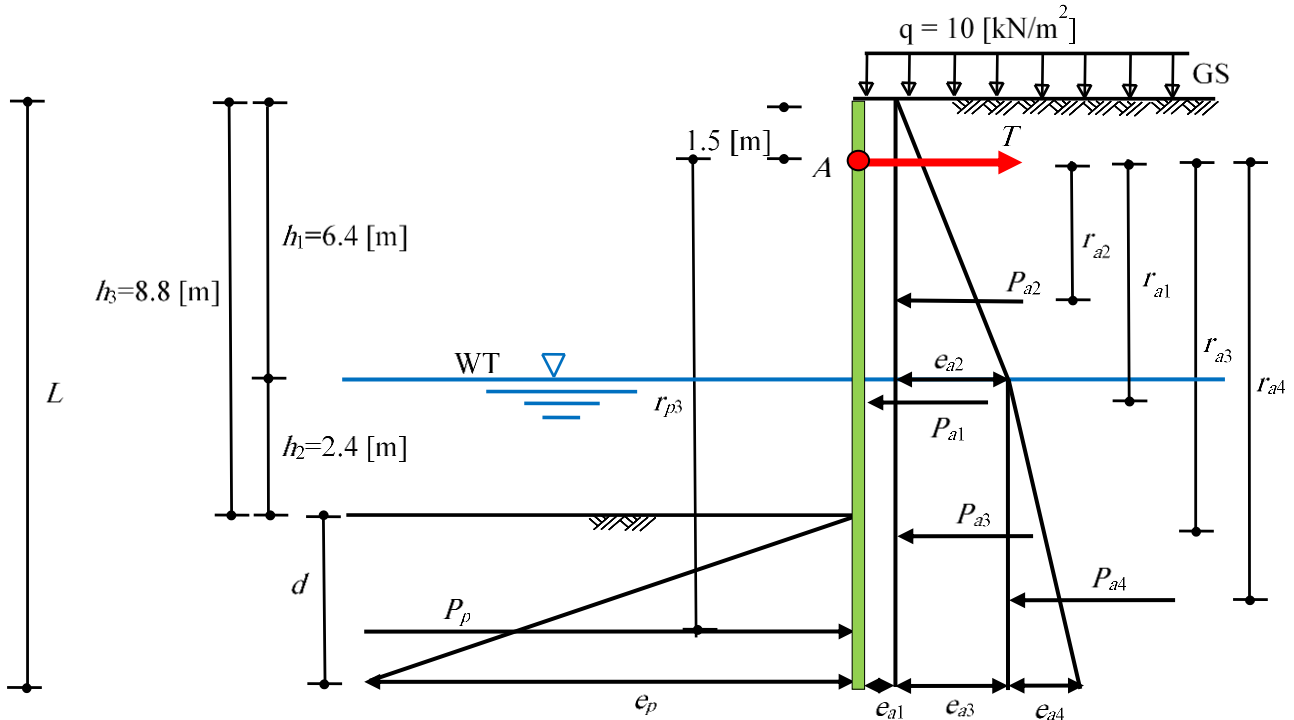

Figure 5.38 Earth pressures diagrams

Table 5.20 Earth pressures on the pile wall

Soil	Earth pressure $e$ [kN/m <sup>2</sup> ]		
Active	$e_{a1} = q k_a$	$= 10 \times 0.23$	$= 2.33$
	$e_{a2} = \gamma_d h_1 k_a$	$= 17 \times 6.4 \times 0.23$	$= 25.31$
	$e_{a3} = e_{a2}$	$= 17 \times 6.4 \times 0.23$	$= 25.31$
	$e_{a4} = \gamma_{sub} (h_2 + d) k_a$	$= 10.2 \times (2.4 + d) \times 0.23$	$= 2.37 d + 5.7$
Passive	$e_{p3} = \gamma_{sub} d k_p / F_s$	$= 10.2 \times d \times 3.58$	$= 36.54 d$

Table 5.21 Earth forces on the pile wall and moments about point A

Soil	Force $P$ [kN]	Arm from A $r$ [m]	Moment @ A $M = P \times r$ [kN.m]
Active	$P_{a1} = e_{a1} (h_3 + d) = 2.33 d + 20.48$	$2.9 + d/2$	$M_{a1} = 1.16 d^2 + 17.12 d + 59.39$
	$P_{a2} = 0.5 e_{a2} h_1 = 81$	2.77	$M_{a2} = 224.38$
	$P_{a3} = e_{a3} (h_2 + d) = 25.31 d + 60.75$	$6.1 + d/2$	$M_{a3} = 12.66 d^2 + 184.79 d + 370.58$
	$P_{a4} = 0.5 e_{a4} (2.4 + d)$ $= 1.19 d^2 + 5.7 d + 6.83$	$6.5 + 2d/3$	$M_{a4} = 0.79 d^3 + 11.51 d^2 + 41.57 d + 44.42$
$P_{at} = \Sigma P_a = 1.19 d^2 + 33.34 d + 169.07$		$M_{at} = \Sigma M_a = 0.79 d^3 + 25.33 d^2 + 243.48 d + 698.76$	
Passive	$P_p = 0.5 e_{p3} d = 18.27 d^2$	$7.3 + 2d/3$	$M_{pt} = 12.18 d^3 + 133.35 d^2$

**5.5.8.4 Determining penetration depth and pile length**

Take the bending moment at the anchor position A. Thus, by equating active and passive moments about A,  $M_{at} = M_{pt}$

$$0.79 d^3 + 25.33 d^2 + 243.48 d + 698.76 = 12.18 d^3 + 133.35 d^2$$

or

$$11.39 d^3 + 108.02 d^2 - 243.48 d - 698.76 = 0$$

Solving the above equation gives:

$$d = 3.2 \text{ [m]}$$

The algebraic sum of the forces in Table 5.21 must equate to the anchored force, Thus, for  $d = 3.2$  [m],  $T = P_{at} - P_p$

$$T = (1.19 d^2 + 33.34 d + 169.07) - (18.27 d^2) = 100.98 \text{ [kN]}$$

Hence the force in each tie =  $2 \times 100.98 = 201.96 \text{ [kN]}$

Min penetration depth  $L_2 = 3.2 \text{ [m]}$

Factor of safety for penetration depth = 20%. Therefore, the penetration depth with an additional 20% is:

Penetration depth  $d_p = 1.2 \times L_2 = 1.2 \times 3.2 = 3.84 \text{ [m]}$

Pile wall length  $L = h_3 + d_p = 8.8 + 3.84 = 12.64 \text{ [m]}$

Figure 5.39 shows earth pressure diagrams in a single view.

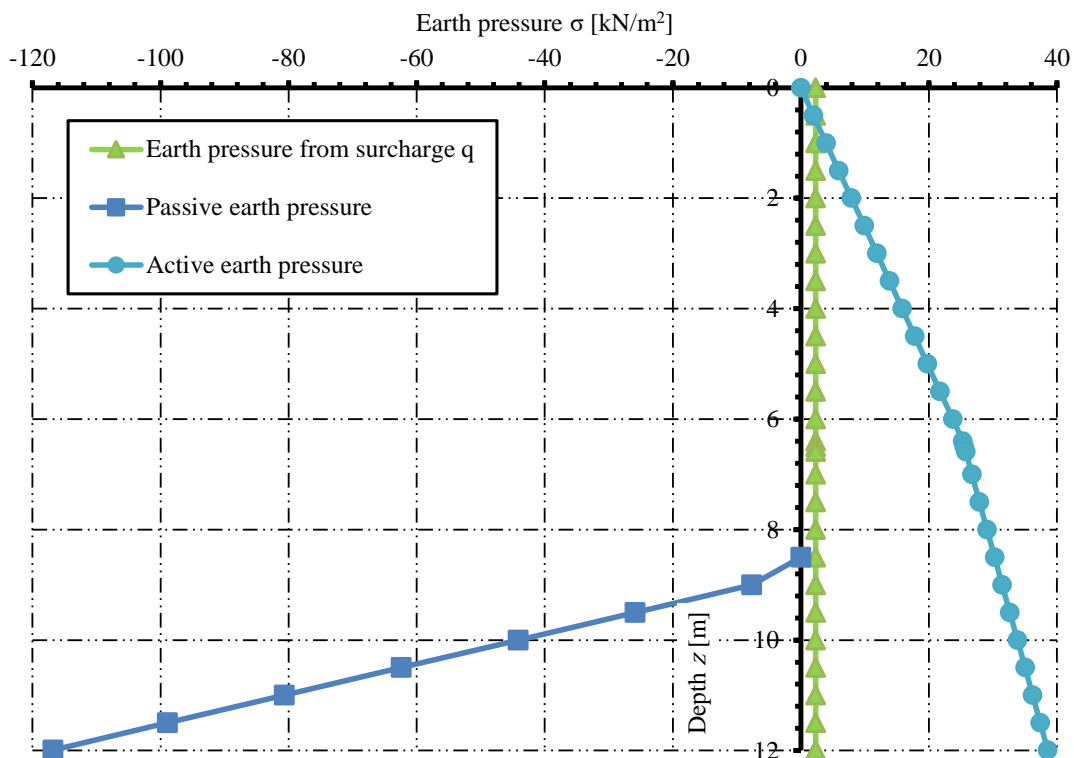

Figure 5.39 Earth pressures diagrams

### 5.5.8.5 Design of sheet pile wall

#### 5.5.8.5.1 Point of zero shear

Point of zero shear is determined from equating active forces and the anchored force  $P_a(y) = T$  at distance  $y$  below the water table, as shown in Figure 5.40. Earth pressures on the pile wall are listed in Table 5.22. Forces, arms, and moments are listed in Table 5.23.

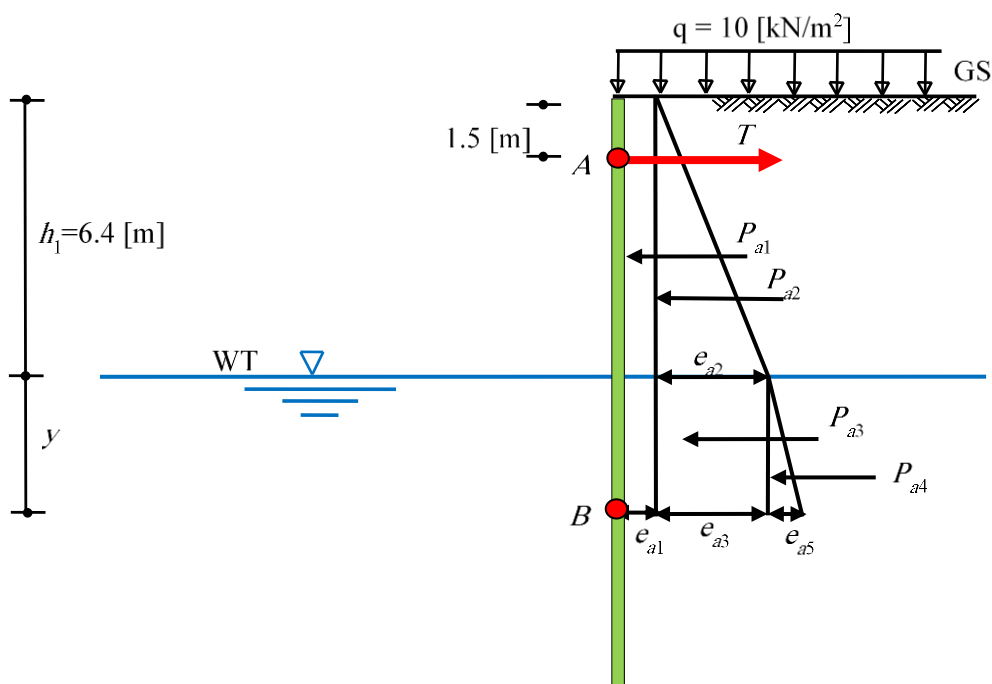

Figure 5.40 Point of zero shear

Table 5.22 Earth pressures on the pile wall

Soil	Earth pressure $e$ [kN/m <sup>2</sup> ]		
Active	$e_{a1} = q k_a$	$= 10 \times 0.233$	$= 2.33$
	$e_{a2} = \gamma_d h_1 k_a$	$= 17 \times 6.4 \times 0.23$	$= 25.31$
	$e_{a3} = e_{a2}$	$= 17 \times 6.4 \times 0.23$	$= 25.31$
	$e_{a4} = \gamma_{sub} y k_a$	$= 10.2 \times y \times 0.23$	$= 2.37 y$

Table 5.23 Earth forces on the pile wall and moments about point A

Soil	Force $P$ [kN]	Arm from B $r$ [m]	Moment @ A $M = P \times r$ [kN.m]
Active	$P_{a1} = e_{a1} (h_3 + y) = 2.33 y + 14.89$	$3.2 + y/2$	$M_{a1} = 1.16 y^2 + 14.89 y + 47.66$
	$P_{a2} = 0.5 e_{a2} h_1 = 81$	$2.133 + y$	$M_{a2} = 172.78 + 81 y$
	$P_{a3} = e_{a3} y = 25.31 y$	$y / 2$	$M_{a3} = 12.66 y^2$
	$P_{a4} = 0.5 e_{a4} y = 1.19 y^2$	$y / 3$	$M_{a4} = 0.4 y^3$
	$P_{at} = \Sigma P_a = 1.19 y^2 + 27.64 y + 95.9$		$M_{at} = \Sigma M_a = 0.4 y^3 + 13.82 y^2 + 95.9 y + 220.44$
Passive	$P_p = T = 100.98$	$4.9 + y$	$M_{pt} = 494.80 + 100.98 y$

$$1.19 y^2 + 27.64 y + 95.9 = 100.98$$

or

$$1.19 y^2 + 27.64 y - 5.09 = 0$$

Solving the above equation, gives the point of zero shear at distance y as:

$$y = 0.18 \text{ [m]}$$

Point of zero shear from the ground surface = 6.58 [m]

### 5.5.8.5.2 Max. Moment

Maximum moment on the wall is calculated in Table 5.24.

Table 5.24 Determining maximum moment  $M_{max}$

Soil	Moment $M = P \times r$ [kN.m]
Active	$M_a = 0.4 y^3 + 13.82 y^2 + 95.9 y + 220.44 = 238.45$
Passive	$M_{pt} = 494.80 + 100.98 y = 513.28$
	$M_{max} = M_{at} - M_{pt} = - 274.83$

### 5.5.8.6 Penetration depth by GEO Tools

The penetration depth obtained by *GEO Tools* for the anchored sheet pile in the sand is equal to that obtained by *Craig* (2012) through hand calculation. The input data and results of *GEO Tools* for this example are presented on the next pages.



# Sheet Pile Wall

---

\*\*\*\*\*  
GEO Tools  
Version 12.2  
Program authors Prof. M. El Gendy/ Dr. A. El Gendy  
\*\*\*\*\*  
Title: Anchored sheet pile wall with free earth support  
Date: 05-11-2021  
Project: Example 11.8, page 451, Soil Mechanics, Graig (2004)  
File: Ex07 Anchored SP in sand

-----  
Anchored sheet pile wall with free earth support  
-----

Data:

Distributed load	q	[kN/m <sup>2</sup> ]	= 10.00
Safety factor for passive resistance	Fs1	[-]	= 1.20
Safety factor for penetration depth	Fs2	[-]	= 1.20
Depth of dredge line	L1	[m]	= 8.80
Anchor depth	D	[m]	= 1.50

Soil Data:

Ground water depth-left	Gwl_L	[m]	= 6.40
Ground water depth-right	Gwl_R	[m]	= 6.40

Layer No.: 1

Cohesion of the soil	C	[kN/m <sup>2</sup> ]	= 0.000
Angle of internal friction	φ	[°]	= 38.50
Dry unit weight of the soil-left	γ <sub>d_L</sub>	[kN/m <sup>3</sup> ]	= 17.00
Saturated unit weight of the soil-left	γ <sub>sat_L</sub>	[kN/m <sup>3</sup> ]	= 20.00
Dry unit weight of the soil-right	γ <sub>d_R</sub>	[kN/m <sup>3</sup> ]	= 17.00
Saturated unit weight of the soil-right	γ <sub>sat_R</sub>	[kN/m <sup>3</sup> ]	= 20.00
Layer thickness	h	[m]	= 15.00

Result:

Sheet pile length	L	[m]	= 12.63
Minimum sheet pile length	L <sub>m</sub>	[m]	= 11.99
Minimum penetration depth	L <sub>2</sub>	[m]	= 3.19
Resistance force at the toe	R	[kN]	= 0.4
Anchor force	T	[kN]	= 100.8
Maximum moment	M <sub>max</sub>	[kN.m]	= -274.08
Moment arm from the ground surface	Y	[m]	= 6.59

---

 Earth pressures on the sheet pile:
 

---

No.	Depth	Passive earth pressure from soil weight	Water pressure left	Active earth pressure from surcharge	Active earth pressure from soil weight	Water pressure right	Earth pressure
I	z	ep	wl	eq	ea	wr	E
[-]	[m]	[kN/m <sup>2</sup> ]	[kN/m <sup>2</sup> ]	[kN/m <sup>2</sup> ]	[kN/m <sup>2</sup> ]	[kN/m <sup>2</sup> ]	[kN/m <sup>2</sup> ]
1	0.00	0.00	0.00	2.33	0.00	0.00	2.33
2	0.50	0.00	0.00	2.33	1.98	0.00	4.30
3	1.00	0.00	0.00	2.33	3.96	0.00	6.28
4	1.49	0.00	0.00	2.33	5.89	0.00	8.22
5	1.50	0.00	0.00	2.33	5.93	0.00	8.26
6	1.51	0.00	0.00	2.33	5.97	0.00	8.30
7	2.00	0.00	0.00	2.33	7.91	0.00	10.24
8	2.50	0.00	0.00	2.33	9.89	0.00	12.21
9	3.00	0.00	0.00	2.33	11.87	0.00	14.19
10	3.50	0.00	0.00	2.33	13.84	0.00	16.17
11	4.00	0.00	0.00	2.33	15.82	0.00	18.15
12	4.50	0.00	0.00	2.33	17.80	0.00	20.12
13	5.00	0.00	0.00	2.33	19.78	0.00	22.10
14	5.50	0.00	0.00	2.33	21.75	0.00	24.08
15	6.00	0.00	0.00	2.33	23.73	0.00	26.06
16	6.40	0.00	-0.10	2.33	25.30	0.10	27.62
17	6.50	0.00	-1.08	2.33	25.53	1.08	27.86
18	6.59	0.00	-1.96	2.33	25.75	1.96	28.07
19	7.00	0.00	-5.98	2.33	26.72	5.98	29.05
20	7.50	0.00	-10.89	2.33	27.90	10.89	30.23
21	8.00	0.00	-15.79	2.33	29.09	15.79	31.42
22	8.50	0.00	-20.70	2.33	30.28	20.70	32.60
23	8.79	0.00	-23.54	2.33	30.96	23.54	33.29
24	8.80	-0.36	-23.64	2.33	30.99	23.64	32.95
25	8.81	-0.73	-23.74	2.33	31.01	23.74	32.61
26	9.00	-7.66	-25.60	2.33	31.46	25.60	26.12
27	9.50	-25.91	-30.51	2.33	32.65	30.51	9.06
28	10.00	-44.16	-35.41	2.33	33.83	35.41	-8.01
29	10.50	-62.41	-40.32	2.33	35.02	40.32	-25.07
30	11.00	-80.66	-45.22	2.33	36.20	45.22	-42.13
31	11.50	-98.91	-50.13	2.33	37.39	50.13	-59.20
32	11.99	-116.80	-54.94	2.33	38.55	54.94	-75.92

---

## Sheet Pile Wall

---

Shear Forces/ Moments:

No. I	Depth z [m]	Shear force Q [kN]	Moment M [kN.m]
1	0.00	0.00	0.00
2	0.50	-1.66	0.37
3	1.00	-4.30	1.82
4	1.49	-7.86	4.76
5	1.50	-7.94	4.84
6	1.51	92.81	3.91
7	2.00	88.27	-40.49
8	2.50	82.66	-83.26
9	3.00	76.06	-122.98
10	3.50	68.47	-159.15
11	4.00	59.89	-191.28
12	4.50	50.32	-218.88
13	5.00	39.76	-241.44
14	5.50	28.22	-258.48
15	6.00	15.68	-269.49
16	6.40	4.94	-273.64
17	6.50	2.17	-274.00
18	6.59	-0.35	-274.08
19	7.00	-12.06	-271.55
20	7.50	-26.88	-261.84
21	8.00	-42.29	-244.58
22	8.50	-58.29	-219.46
23	8.79	-67.85	-201.17
24	8.80	-68.18	-200.49
25	8.81	-68.51	-199.81
26	9.00	-74.09	-186.25
27	9.50	-82.88	-146.65
28	10.00	-83.14	-104.79
29	10.50	-74.87	-64.93
30	11.00	-58.07	-31.34
31	11.50	-32.74	-8.28
32	11.99	0.36	-0.02

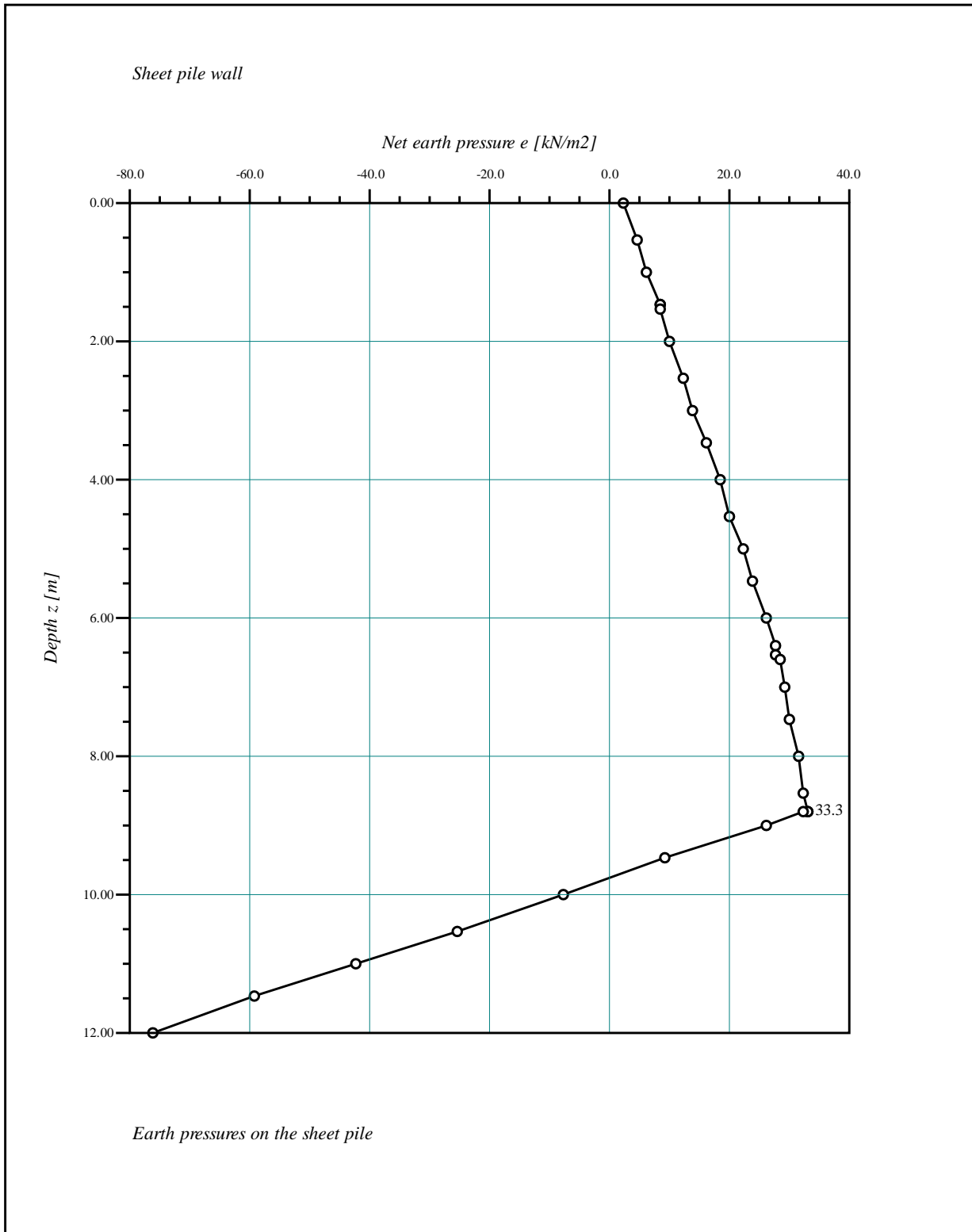

<p><b>GEOTEC Software Inc</b>                  PO Box 14001 Richmond Road PO, Calgary AB, Canada T3E 7Y7</p>	
<p>Scale: 769                  File: Ex07                  Page No.:</p>	<p>Project: Example 11.8, page 451, Soil Mechanics, Graig (2004)                  Date: 05-11-2021                  Title: Anchored sheet pile wall with free earth support</p>

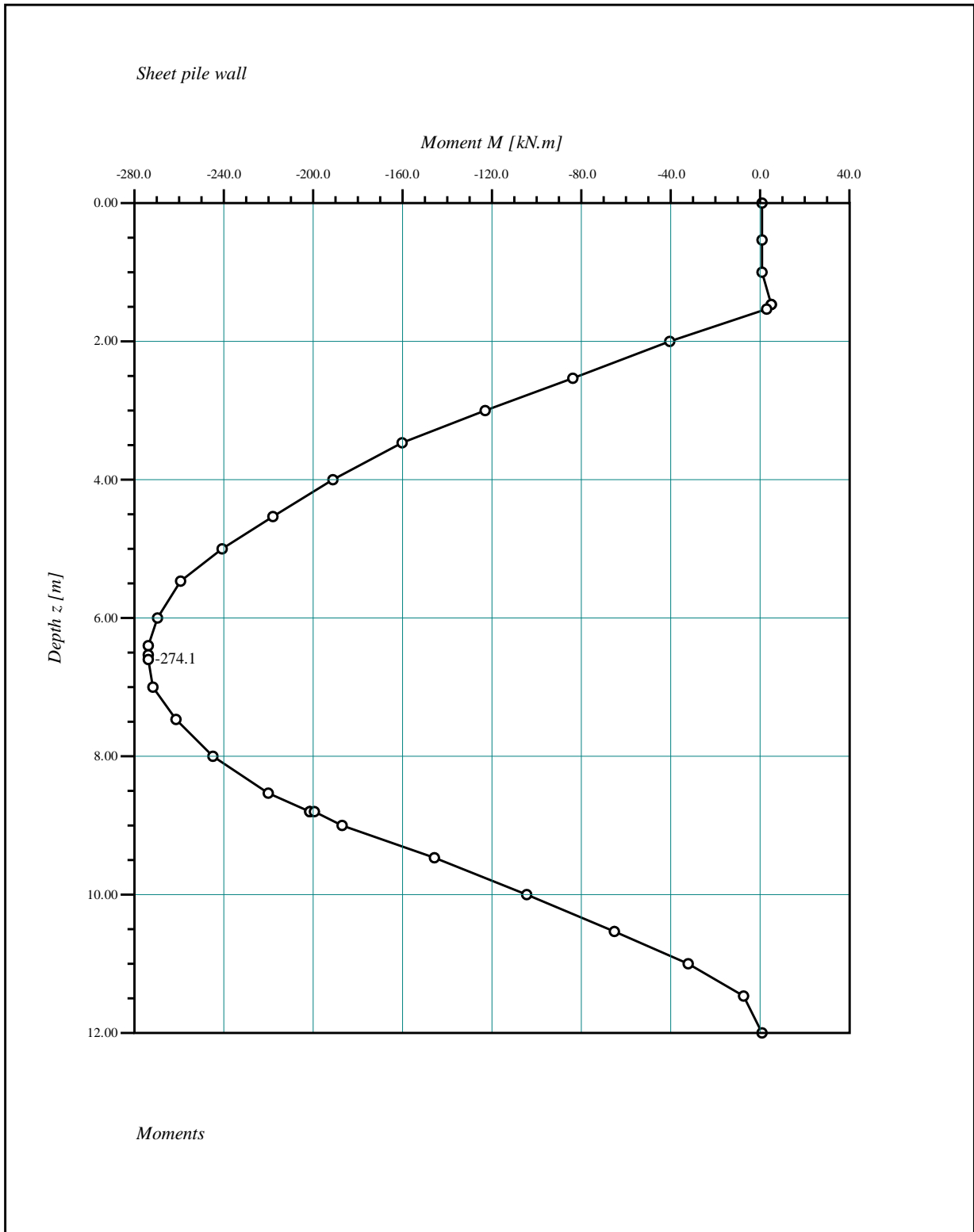

<b>GEOTEC Software Inc</b>	
<b>PO Box 14001 Richmond Road PO, Calgary AB, Canada T3E 7Y7</b>	
<b>Scale: 2065</b>	<b>Project: Example 11.8, page 451, Soil Mechanics, Graig (2004)</b>
<b>File: Ex07</b>	<b>Date: 05-11-2021</b>
<b>Page No.:</b>	<b>Title: Anchored sheet pile wall with free earth support</b>

Sheet pile wall

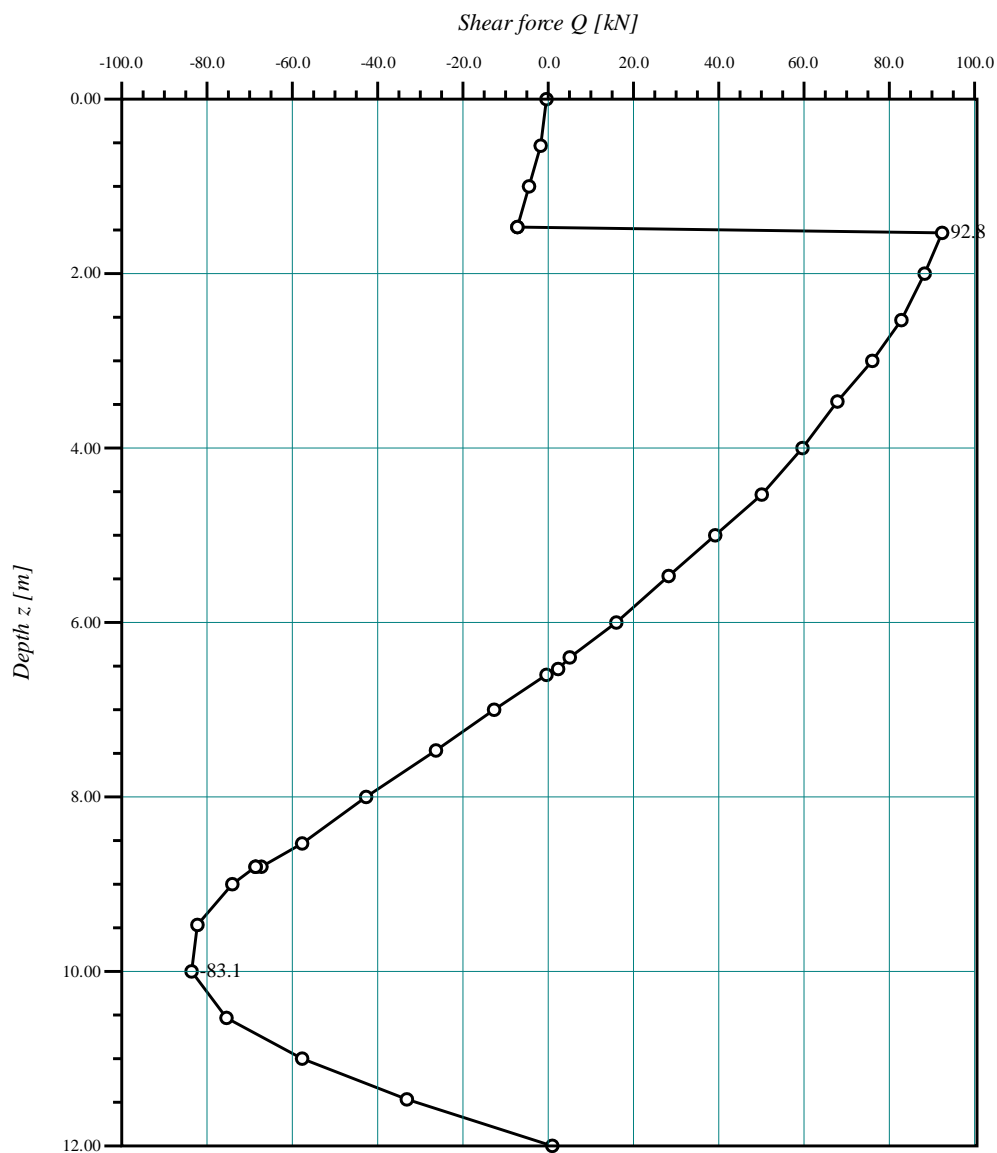

Shear Forces

GEOTEC Software Inc

PO Box 14001 Richmond Road PO, Calgary AB, Canada T3E 7Y7

Scale: 1364

File: Ex07

Page No.:

Project: Example 11.8, page 451, Soil Mechanics, Graig (2004)

Date: 05-11-2021

Title: Anchored sheet pile wall with free earth support

### 5.5.9 Example 8: Sheet pile supported by a strut at the surface

#### 5.5.9.1 Description of the problem

To verify the analysis of sheet pile wall supported by a strut at the surface, the theoretical penetration depth  $d$  for the given sheet pile in Figure 5.41 obtained by hand calculation using free earth support method is compared with that obtained by *GEO Tools*. The sides of an excavation 4 [m] deep in the sand are to be supported by a sheet pile wall with a strut at the surface. The water table is 1.5 [m] below the surface. The unit weight of the sand above the water table is  $\gamma_d = 18$  [kN/m<sup>3</sup>], and the saturated unit weight is  $\gamma_{sat} = 20$  [kN/m<sup>3</sup>] below the water table. Shear parameters are  $c = 0$  [kN/m<sup>2</sup>] and  $\phi = 25$  [°].

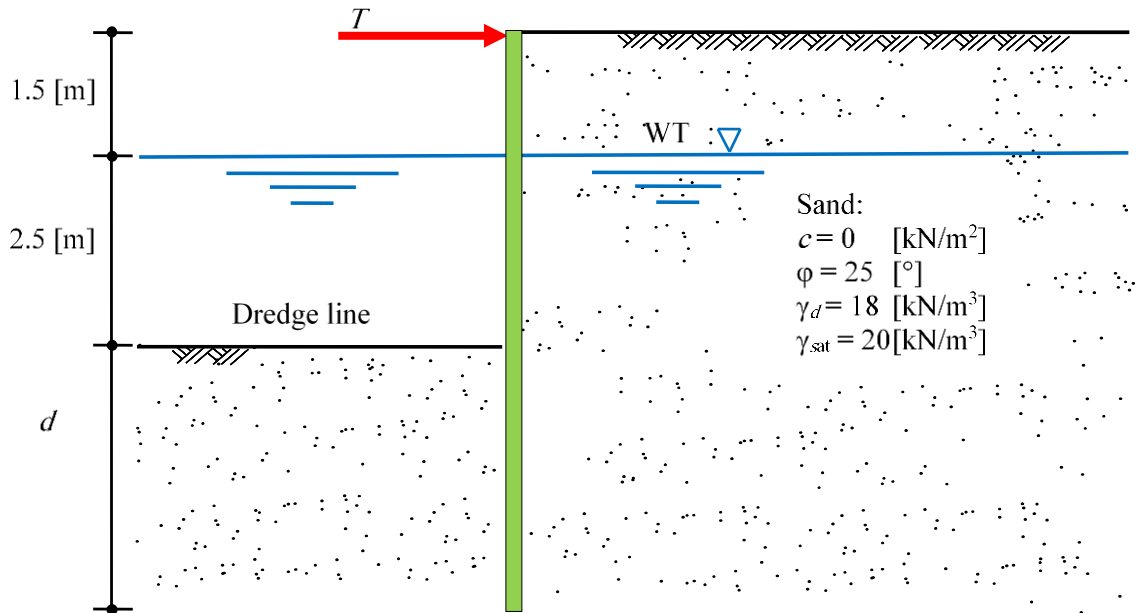

Figure 5.41 Anchored sheet pile with free earth support

#### 5.5.9.2 Soil parameters and earth pressure coefficients

Dry unit weight of the soil	$\gamma_d$	= 18 [kN/m <sup>3</sup> ]
Saturated unit weight of the soil	$\gamma_{sat}$	= 20 [kN/m <sup>3</sup> ]
Submerged unit weight of the soil	$\gamma_{Sub}$	= 20 - 9.81 = 10.2 [kN/m <sup>3</sup> ]
Angle of internal friction of the soil	$\phi$	= 25 [°]
Active earth pressure coefficient	$k_a$	= (1 - sin $\phi$ ) / (1 + sin $\phi$ ) = 0.41
Passive earth pressure coefficient	$k_p$	= (1 + sin $\phi$ ) / (1 - sin $\phi$ ) = 2.46

#### 5.5.9.3 Determining earth pressures, forces and moments on the wall

The design dimensions and the earth pressure diagrams are shown in Figure 5.42. The procedure is to equate moments about A, the position of the strut. Earth pressures on the pile wall are listed in Table 5.25. Forces, arms, and moments are listed in Table 5.26. The water levels on the two sides of the wall are equal. Therefore, the hydrostatic pressure distributions are in balance and can be eliminated from the calculations.

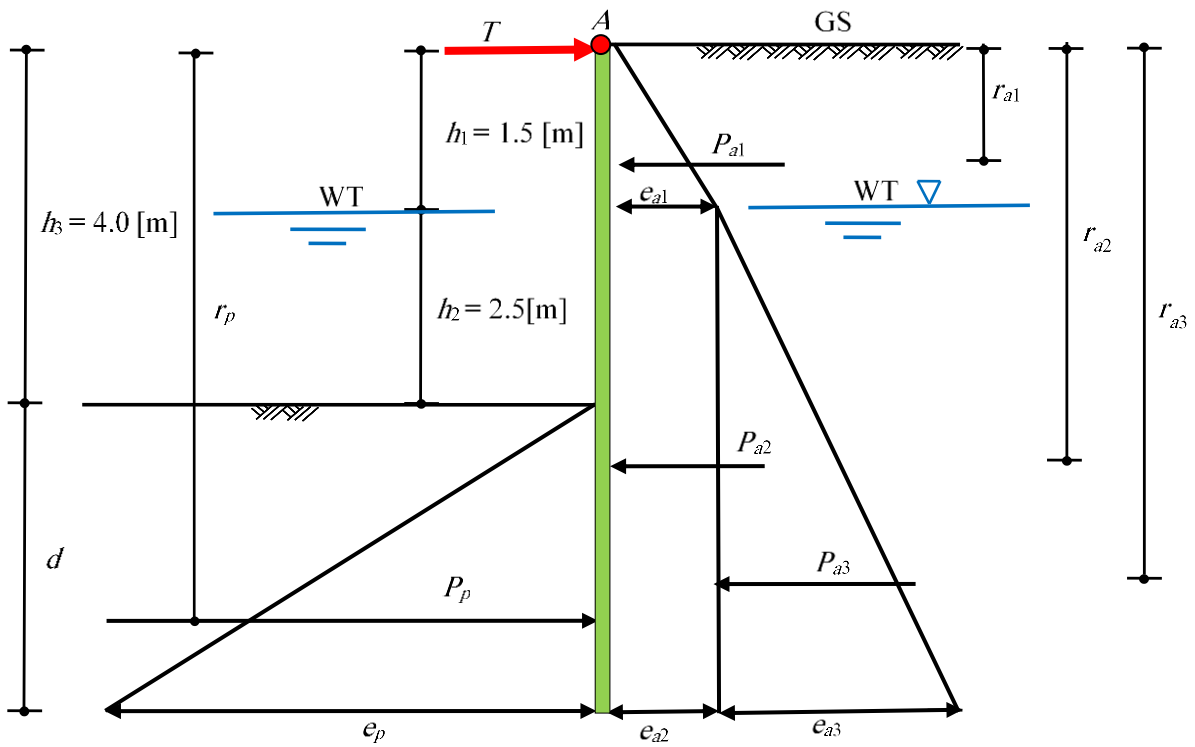

Figure 5.42 Earth pressures diagrams

Table 5.25 Earth pressures on the pile wall

Soil	Earth pressure $e$ [kN/m <sup>2</sup> ]		
Active	$e_{a1} = \gamma_d h_1 k_a$	$= 18 \times 1.5 \times 0.41$	$= 10.96$
	$e_{a2} = e_{a1}$	$= 10.96$	$= 10.96$
	$e_{a3} = \gamma_{sub} (h_2 + d) k_a$	$= 10.2 \times (2.5 + d) \times 0.41$	$= 4.14 d + 10.35$
Passive	$e_{p1} = \gamma_{sub} d k_p$	$= 10.2 \times d \times 2.46$	$= 25.13 d$

Table 5.26 Earth forces on the pile wall and moments about point A

Soil	Force $P$ [kN]	Arm from A $r$ [m]	Moment @ A $M = P \times r$ [kN.m]
Active	$P_{a1} = 0.5 e_{a1} h_1 = 8.22$	1	$M_{a1} = 8.22$
	$P_{a2} = e_{a2} (h_2 + d) = 27.4 + 10.96 d$	$2.75 + d/2$	$M_{a2} = 5.48 d^2 + 43.83 d + 75.34$
	$P_{a3} = 0.5 e_{a3} (h_2 + d) = 2.07 d^2 + 10.35 d + 12.94$	$3.17 + 2d/3$	$M_{a4} = 1.38 d^3 + 13.46 d^2 + 41.41 d + 40.98$
	$P_{at} = \Sigma P_a = 2.07 d^2 + 21.31 d + 48.56$		$M_{at} = \Sigma M_a = 1.38 d^3 + 18.94 d^2 + 85.24 d + 124.54$
Passive	$P_p = 0.5 e_p d = 12.57 d^2$	$4 + 2d/3$	$M_{pt} = 8.38 d^3 + 50.26 d^2$



**5.5.9.4 Determining penetration depth and pile length**

Take the bending moment at the anchor position A. Thus, by equating active and passive moments about A,  $M_{at} = M_{pt}$

$$1.38 d^3 + 18.94 d^2 + 85.24 d + 124.54 = 8.38 d^3 + 50.26 d^2$$

Or

$$7 d^3 + 31.33 d^2 - 85.24 d - 124.54 = 0$$

Solving the above equation gives:

$$d = 2.65 \text{ [m]}$$

The algebraic sum of the forces in Table 5.26 must equate to force in the anchored, Thus, for  $d = 2.65$  [m],  $T = P_{at} - P_p$

$$T = 2.07 d^2 + 21.31 d + 48.56 - 12.57 d^2$$

$$T = 2.07 \times 2.65^2 + 21.31 \times 2.65 + 48.56 - 12.57 \times 2.65^2$$

$$T = 31.28 \text{ [kN]}$$

Figure 5.43 shows earth pressure diagrams in a single view.

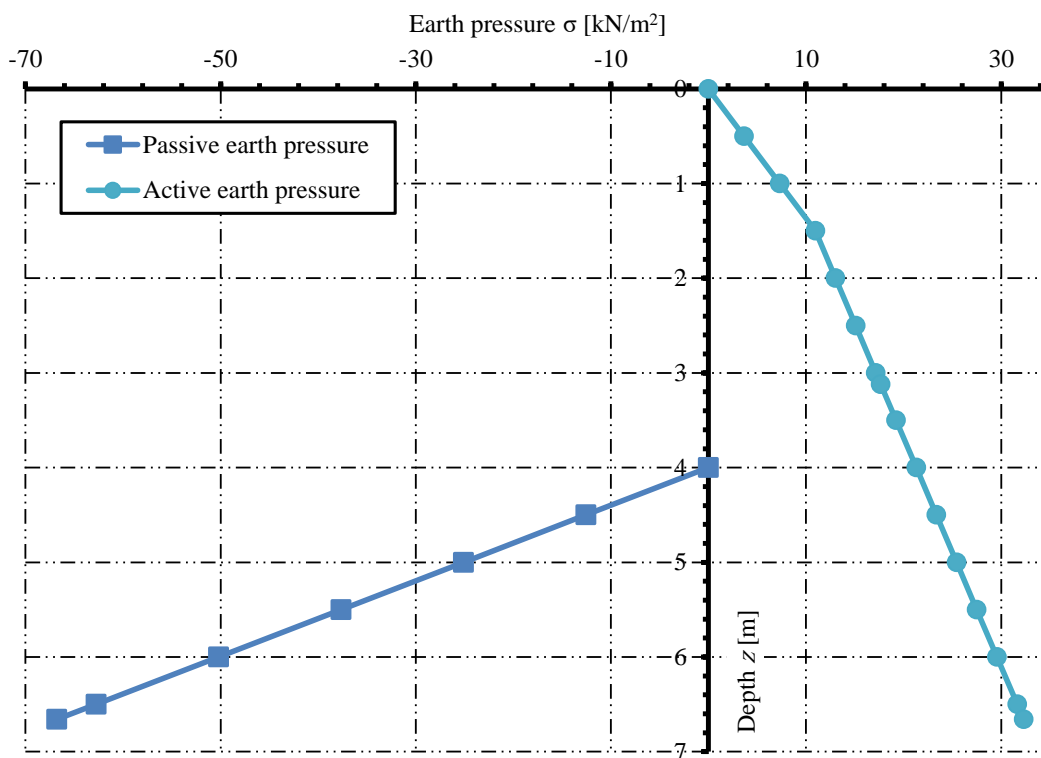

Figure 5.43 Earth pressures diagrams

5.5.9.5 Design of sheet pile wall

5.5.9.5.1 Point of zero shear

Point of zero shear is determined from equating active forces and the anchored force  $P_a(y) = T$  at distance  $y$  below the water table, as shown in Figure 5.44. Earth pressures on the pile wall are listed in Table 5.27. Forces, arms, and moments are listed in Table 5.28.

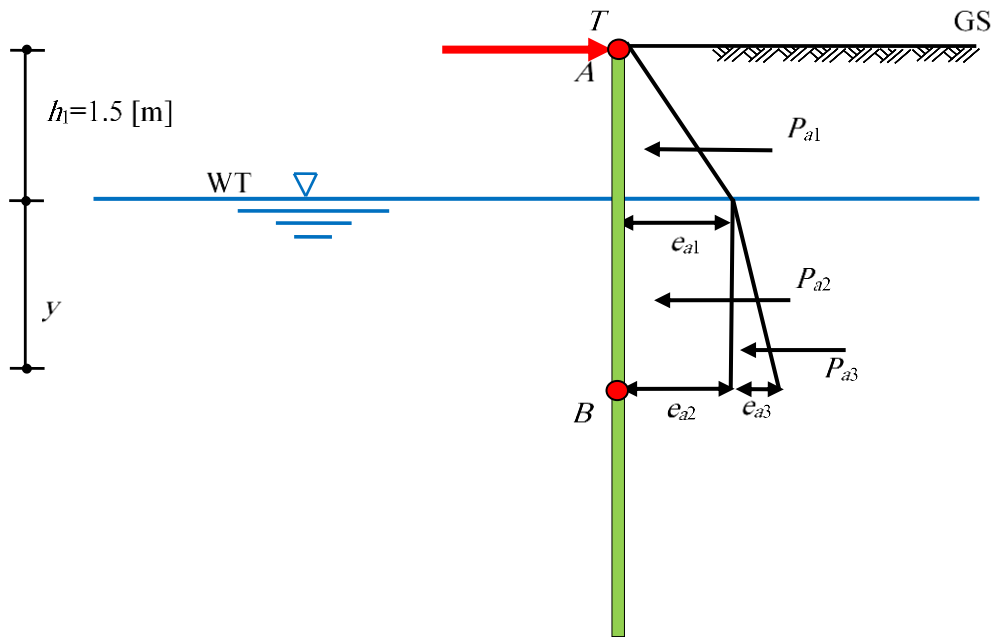

Figure 5.44 Point of zero shear

Table 5.27 Earth pressures on the pile wall

Soil	Earth pressure $e$ [kN/m <sup>2</sup> ]		
Active	$e_{a1} = \gamma_d h_1 k_a$	$= 18 \times 1.5 \times 0.41$	$= 10.96$
	$e_{a2} = e_{a1}$	$= 18 \times 1.5 \times 0.41$	$= 10.96$
	$e_{a3} = \gamma_{sub} y k_a$	$= 10.2 \times y \times 0.41$	$= 4.14 y$

Table 5.28 Earth forces on the pile wall and moments about point A

Soil	Force $P$ [kN]	Arm from B $r$ [m]	Moment @ A $M = P \times r$ [kN.m]
Active	$P_{a1} = 0.5 e_{a1} h_1 = 8.22$	$0.5 + y$	$M_{a1} = 4.11 + 8.22 y$
	$P_{a2} = e_{a2} y = 10.96 y$	$y/2$	$M_{a2} = 5.48 y^2$
	$P_{a3} = 0.5 e_{a3} y = 2.07 y^2$	$y/3$	$M_{a3} = 0.69 y^3$
	$P_{at} = \Sigma P_a = 2.07 y^2 + 10.96 y + 8.22$		$M_{at} = \Sigma M_a = 0.69 y^3 + 5.48 y^2 + 8.22 y + 4.11$
Passive	$P_p = T = 31.28$	$1.5 + y$	$M_{pt} = 46.93 + 31.28 y$

$$2.07 y^2 + 10.96 y + 8.22 = 31.28$$

or

$$2.07 y^2 + 10.96 y - 23.07 = 0$$

Solving the above equation, gives the point of zero shear at distance  $y$  as:

$$y = 1.61 \text{ [m]}$$

Point of zero shear from the ground surface = 3.11 [m]

#### 5.5.9.5.2 Max. Moment

Maximum moment on the wall is calculated in Table 5.29.

Table 5.29 Determining maximum moment  $M_{max}$

Soil	Moment $M = P \times r$ [kN.m]
Active	$M_{at} = 0.69 y^3 + 5.48 y^2 + 8.22 y + 4.11 = 34.52$
Passive	$M_{pt} = 46.93 + 31.28 y = 97.39$
	$M_{max} = M_{at} - M_{pt} = 62.87$

#### 5.5.9.6 Penetration depth by GEO Tools

The theoretical penetration depth obtained by *GEO Tools* for the sheet pile in the sand with a strut at the surface is equal to that obtained by hand calculation. The input data and results of *GEO Tools* for this example are presented on the next pages.

\*\*\*\*\*

GEO Tools  
Version 12.2

Program authors Prof. M. El Gendy/ Dr. A. El Gendy

\*\*\*\*\*

Title: Sheet pile supported by a strut at the surface

Date: 06-11-2021

Project: Examples to verify sheet pile wall

File: Ex08 SP supported by a strut

-----  
Anchored sheet pile wall with free earth support  
-----

Data:

Distributed load	q	[kN/m <sup>2</sup> ]	= 0.00
Safety factor for passive resistance	Fs1	[-]	= 1.00
Safety factor for penetration depth	Fs2	[-]	= 1.00
Depth of dredge line	L1	[m]	= 4.00
Anchor depth	D	[m]	= 0.00

Soil Data:

Ground water depth-left	Gwl_L	[m]	= 1.50
Ground water depth-right	Gwl_R	[m]	= 1.50

Layer No.: 1

Cohesion of the soil	C	[kN/m <sup>2</sup> ]	= 0.000
Angle of internal friction	φ	[°]	= 25.00
Dry unit weight of the soil-left	γ <sub>d_L</sub>	[kN/m <sup>3</sup> ]	= 18.00
Saturated unit weight of the soil-left	γ <sub>sat_L</sub>	[kN/m <sup>3</sup> ]	= 20.00
Dry unit weight of the soil-right	γ <sub>d_R</sub>	[kN/m <sup>3</sup> ]	= 18.00
Saturated unit weight of the soil-right	γ <sub>sat_R</sub>	[kN/m <sup>3</sup> ]	= 20.00
Layer thickness	h	[m]	= 10.00

Result:

Sheet pile length	L	[m]	= 6.66
Minimum sheet pile length	L <sub>m</sub>	[m]	= 6.66
Minimum penetration depth	L <sub>2</sub>	[m]	= 2.66
Resistance force at the toe	R	[kN]	= 0.3
Anchor force	T	[kN]	= 31.3
Maximum moment	M <sub>max</sub>	[kN.m]	= -62.87
Moment arm from the ground surface	Y	[m]	= 3.12

## Sheet Pile Wall

Earth pressures on the sheet pile:

No.	Depth	Passive earth pressure from soil weight	Water pressure left	Active earth pressure from soil weight	Water pressure right	Earth pressure
I	z	ep	wl	ea	wr	E
[-]	[m]	[kN/m <sup>2</sup> ]	[kN/m <sup>2</sup> ]	[kN/m <sup>2</sup> ]	[kN/m <sup>2</sup> ]	[kN/m <sup>2</sup> ]
1	0.00	0.00	0.00	0.00	0.00	0.00
2	0.01	0.00	0.00	0.07	0.00	0.07
3	0.50	0.00	0.00	3.65	0.00	3.65
4	1.00	0.00	0.00	7.31	0.00	7.31
5	1.50	0.00	0.00	10.96	0.00	10.96
6	2.00	0.00	-4.91	13.03	4.91	13.03
7	2.50	0.00	-9.81	15.09	9.81	15.09
8	3.00	0.00	-14.71	17.16	14.71	17.16
9	3.12	0.00	-15.89	17.66	15.89	17.66
10	3.50	0.00	-19.62	19.23	19.62	19.23
11	3.99	0.00	-24.43	21.26	24.43	21.26
12	4.00	0.00	-24.53	21.30	24.53	21.30
13	4.01	-0.25	-24.62	21.34	24.62	21.09
14	4.50	-12.55	-29.43	23.37	29.43	10.81
15	5.00	-25.11	-34.34	25.43	34.34	0.33
16	5.50	-37.66	-39.24	27.50	39.24	-10.16
17	6.00	-50.21	-44.14	29.57	44.14	-20.65
18	6.50	-62.77	-49.05	31.64	49.05	-31.13
19	6.66	-66.79	-50.62	32.30	50.62	-34.49

Shear Forces/ Moments:

No.	Depth	Shear force	Moment
I	z	Q	M
	[m]	[kN]	[kN.m]
1	0.00	0.00	0.00
2	0.01	31.28	-0.31
3	0.50	30.37	-15.49
4	1.00	27.63	-30.06
5	1.50	23.06	-42.81
6	2.00	17.07	-52.89
7	2.50	10.04	-59.71
8	3.00	1.97	-62.76
9	3.12	-0.12	-62.87
10	3.50	-7.12	-61.51
11	3.99	-17.04	-55.63
12	4.00	-17.26	-55.46
13	4.01	-17.47	-55.29
14	4.50	-25.28	-44.61
15	5.00	-28.07	-31.05
16	5.50	-25.61	-17.41
17	6.00	-17.91	-6.32
18	6.50	-4.96	-0.38
19	6.66	0.29	0.00

Sheet pile wall

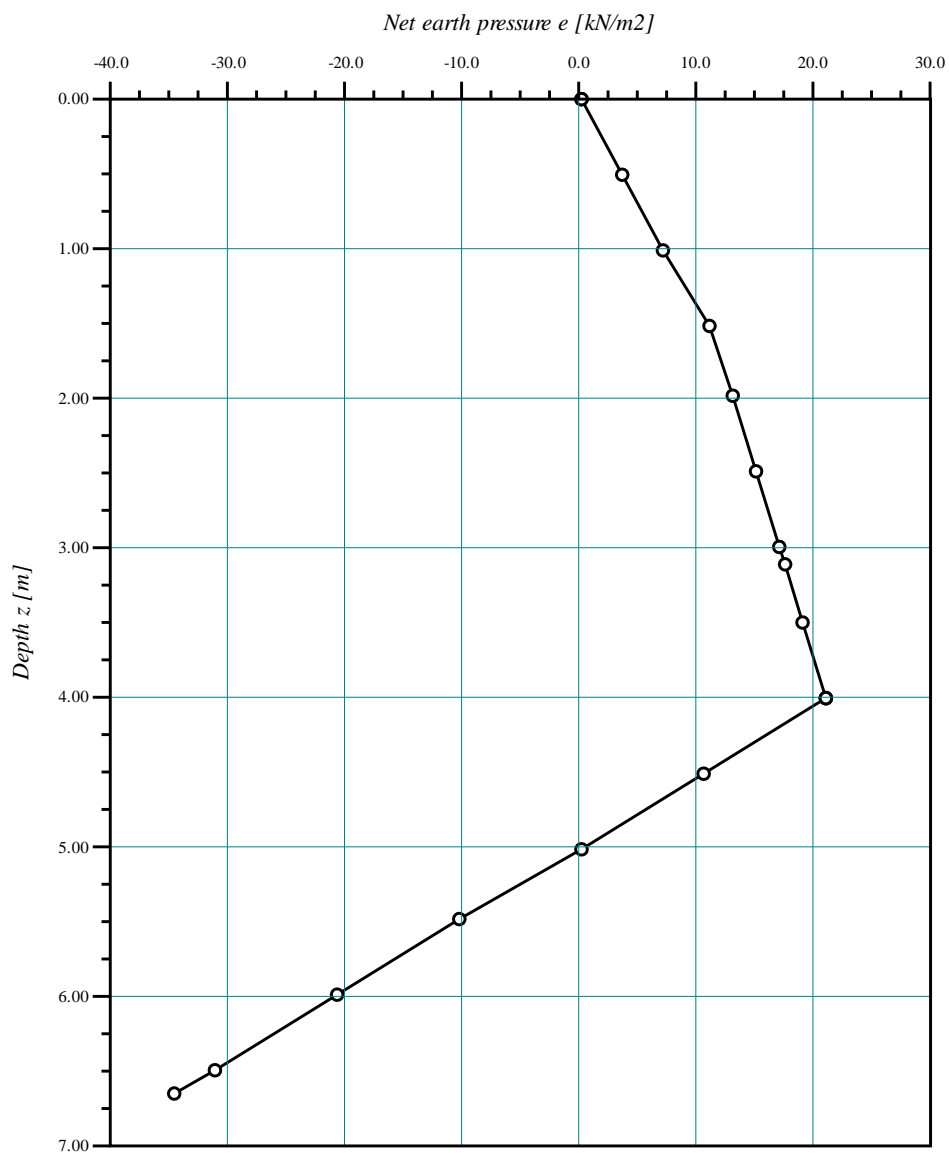

GEOTEC Software Inc

PO Box 14001 Richmond Road PO, Calgary AB, Canada T3E 7Y7

Scale: 497

File: Ex08

Page No.:

Project: Examples to verify sheet pile wall

Date: 06-11-2021

Title: Sheet pile supported by a strut at the surface

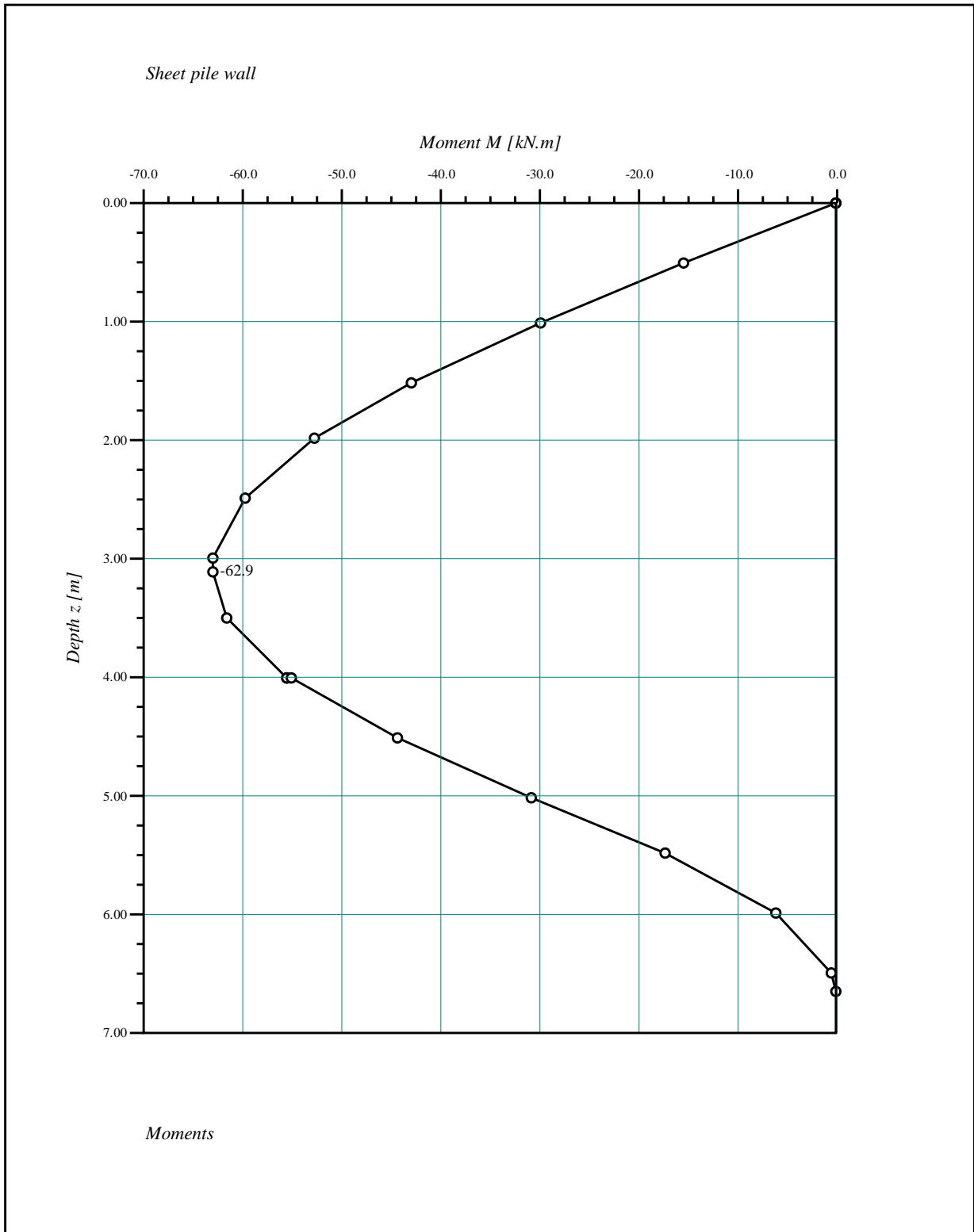

<p><b>GEOTEC Software Inc</b>                  PO Box 14001 Richmond Road PO, Calgary AB, Canada T3E 7Y7</p>	
<p><b>Scale: 466</b>  <b>File: Ex08</b>  <b>Page No.:</b></p>	<p><b>Project: Examples to verify sheet pile wall</b>  <b>Date: 06-11-2021</b>  <b>Title: Sheet pile supported by a strut at the surface</b></p>

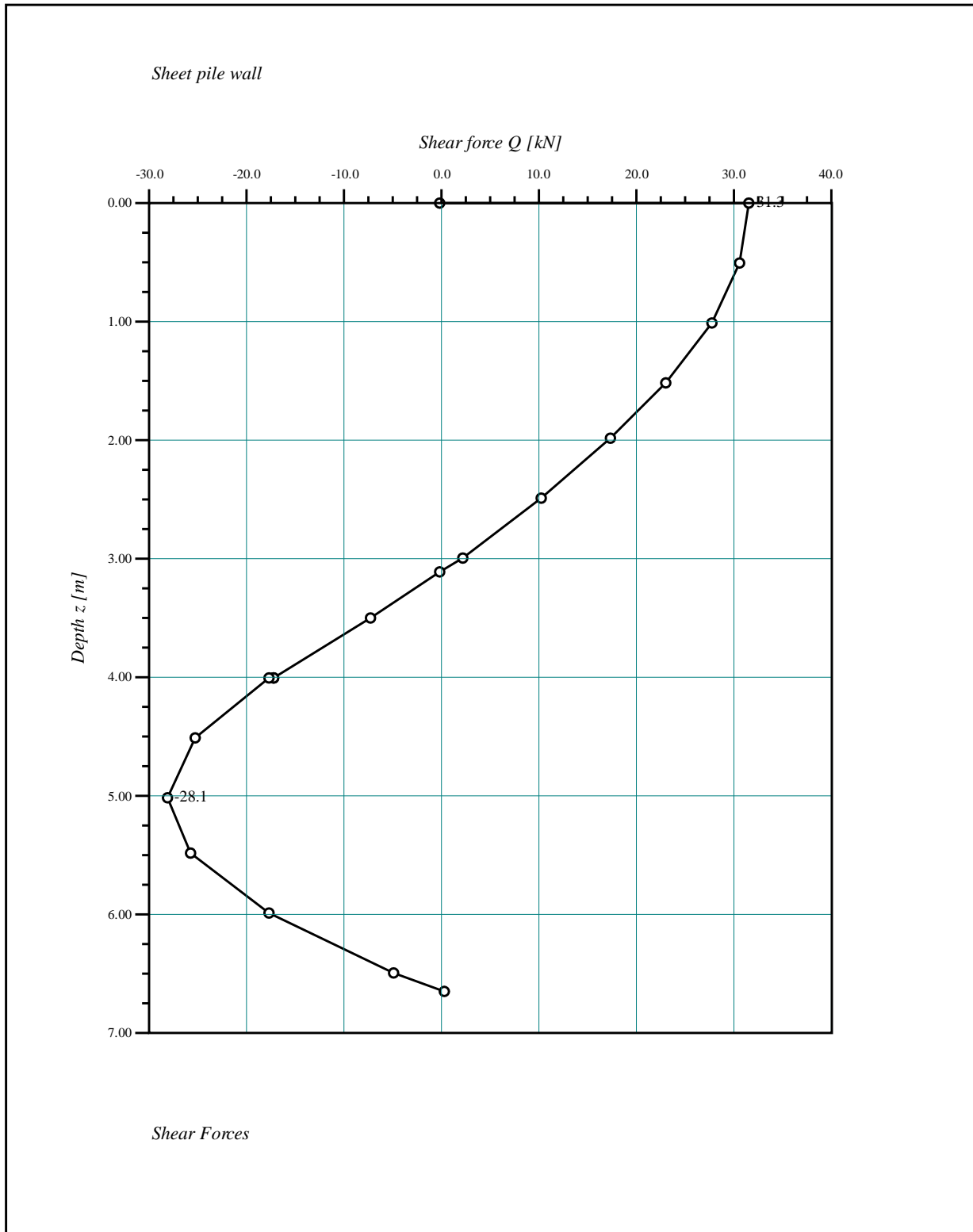

<p><b>GEOTEC Software Inc</b>                  PO Box 14001 Richmond Road PO, Calgary AB, Canada T3E 7Y7</p>	
<p><b>Scale:</b> 474  <b>File:</b> Ex08  <b>Page No.:</b></p>	<p><b>Project:</b> Examples to verify sheet pile wall  <b>Date:</b> 06-11-2021  <b>Title:</b> Sheet pile supported by a strut at the surface</p>



**5.5.10 Example 9: Anchored sheet pile penetrating in clay**

**5.5.10.1 Description of the problem**

To verify the analysis of anchored sheet pile penetrating in clay, the theoretical penetration depth  $d$  for the given anchored sheet pile penetrating in clay in Figure 5.45 obtained by *Das* (2011), Example (9.10) page 484, through hand calculation using free earth support method is compared with that obtained by *GEO Tools*. The unit weight and shear parameters of the soil layers are shown in Figure 5.45.

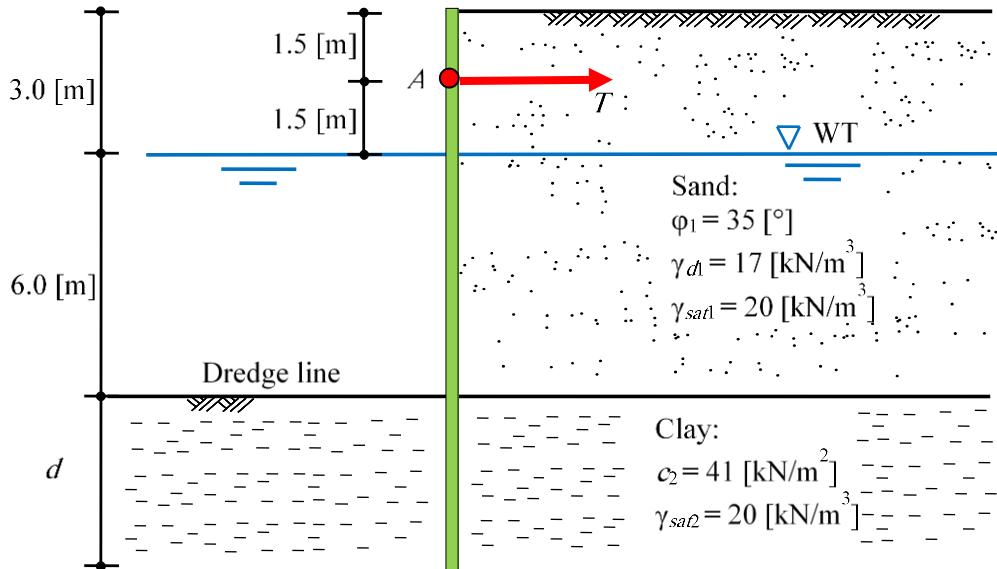

Figure 5.45 Anchored sheet pile penetrating in clay

**5.5.10.2 Soil parameters and earth pressure coefficients**

Sand layer:

Dry unit weight of the soil	$\gamma_{d1}$	= 17	[kN/m <sup>3</sup> ]
Saturated unit weight of the soil	$\gamma_{sat1}$	= 20	[kN/m <sup>3</sup> ]
Submerged unit weight of the soil	$\gamma_{Sub1}$	= 20 – 9.81 = 10.2	[kN/m <sup>3</sup> ]
Angle of internal friction of the soil	$\phi_1$	= 35	[°]
Active earth pressure coefficient	$k_{a1}$	= (1 – sin $\phi$ ) / (1 + sin $\phi$ ) = 0.27	

Clay layer:

Saturated unit weight of the soil	$\gamma_{sat2}$	= 20	[kN/m <sup>3</sup> ]
Submerged unit weight of the soil	$\gamma_{Sub2}$	= 20 – 9.81 = 10.2	[kN/m <sup>3</sup> ]
Angle of internal friction of the soil	$\phi_2$	= 0	[°]
Cohesion of the soil	$c_2$	= 41	[kN/m <sup>2</sup> ]
Active earth pressure coefficient	$k_{a2}$	= (1 – sin $\phi$ ) / (1 + sin $\phi$ ) = 1	
Passive earth pressure coefficient	$k_{p2}$	= 1/ $k_{a3}$ = 1	

**5.5.10.3 Determining earth pressures, forces and moments on the wall**

The design dimensions and the earth pressure diagrams are shown in Figure 5.46. The procedure is to equate moments about *A*, the position of the anchored. Earth pressures on the pile wall are listed in Table 5.30. Forces, arms, and moments are listed in Table 5.31. The water levels on the two sides of the wall are equal. Therefore, the hydrostatic pressure distributions are in balance and can be eliminated from the calculations.

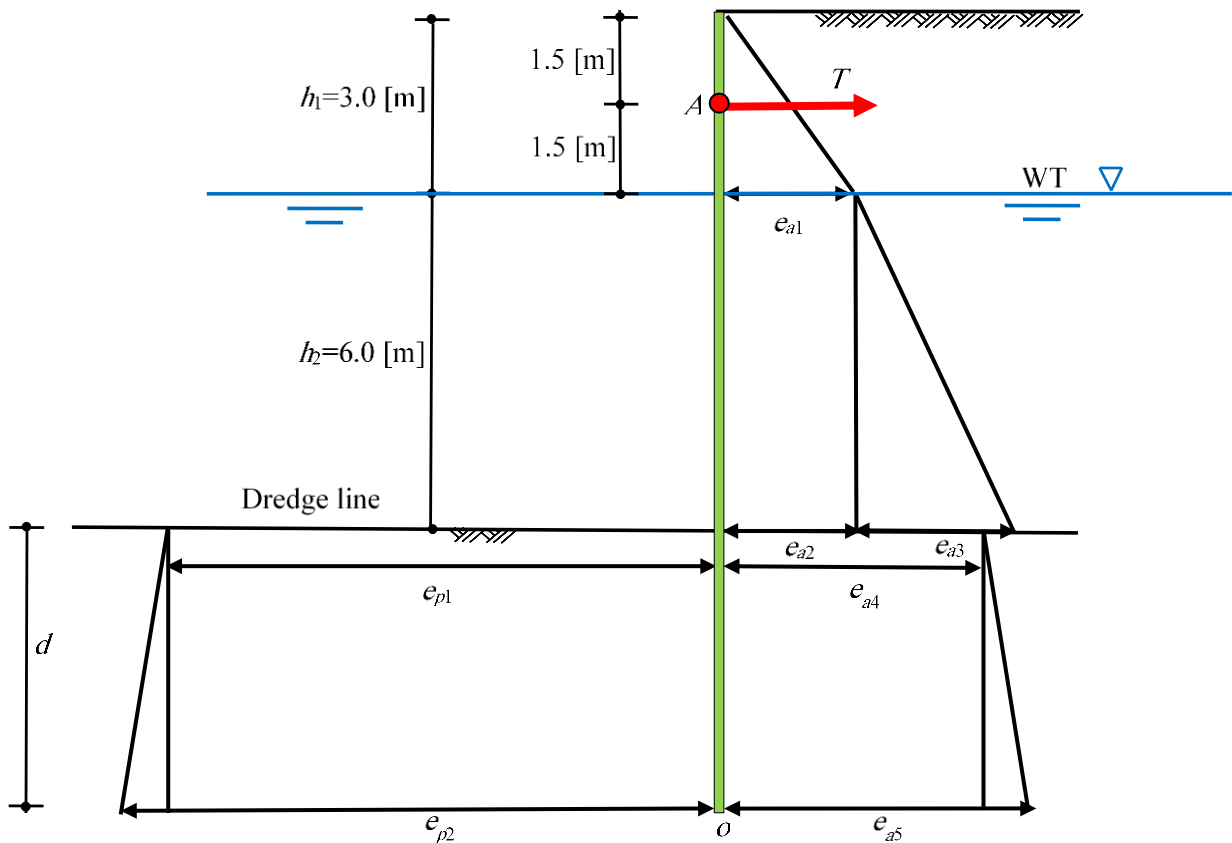

Figure 5.46 Earth pressures diagrams

In the analysis, it is convenient to obtain the net earth pressure distribution under the dredge line. This is done by subtracting the active earth pressure from the passive earth pressure under the dredge line. Figure 5.47 shows the net earth pressure diagrams.

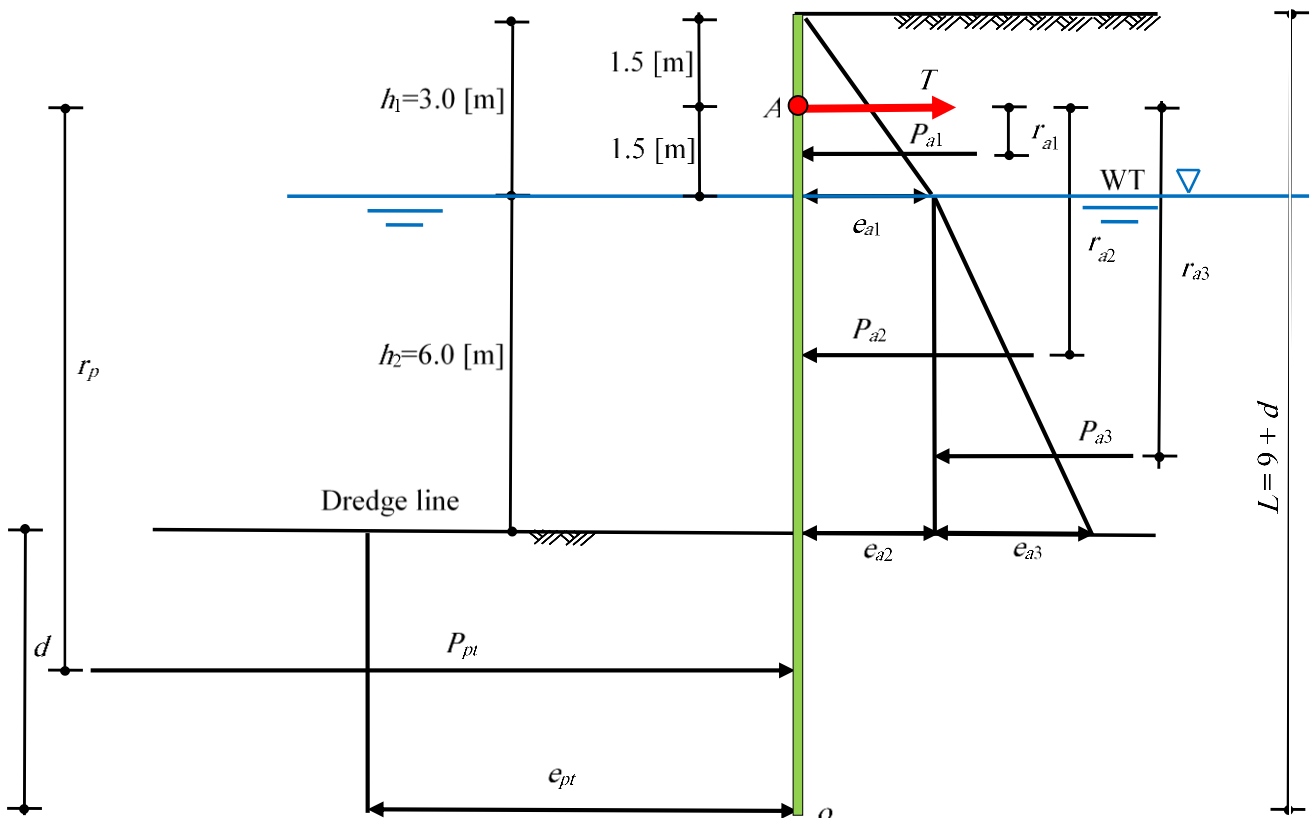

Figure 5.47 Net earth pressures diagrams

Table 5.30 Earth pressures on the pile wall

Soil	Earth pressure $e$ [kN/m <sup>2</sup> ]		
Active	$e_{a1} = \gamma_{d1} h_1 k_{a1}$	$= 17 \times 3 \times 0.27$	$= 13.82$
	$e_{a2} = e_{a1}$	$= 13.82$	$= 13.82$
	$e_{a3} = \gamma_{sub1} h_2 k_{a1}$	$= 10.2 \times 6 \times 0.271$	$= 16.59$
Net passive	$e_{pt} = 4c - q$	$= 4 \times 41 - (17 \times 3 + 10.2 \times 6)$	$= 51.8 (-)$

Table 5.31 Earth forces on the pile wall and moments about point A

Soil	Force $P$ [kN]	Arm from A $r$ [m]	Moment @ o $M = P \times r$ [kN.m]
Active	$P_{a1} = 0.5 e_{a1} h_1 = 20.73$	0.5	$M_{a1} = 10.37$
	$P_{a2} = e_{a2} h_2 = 82.93$	4.5	$M_{a2} = 373.17$
	$P_{a3} = 0.5 e_{a3} h_2 = 49.76$	5.5	$M_{a3} = 273.65$
	$P_{at} = \Sigma P_a = 153.41$		
Passive	$P_p = e_{pt} d = 51.8 d$	$7.5 + d/2$	$M_p = 25.9 d^2 + 388.5 d$

**5.5.10.4 Determining penetration depth and pile length**

Equating active and passive moments about A,  $M_{at} = M_{pt}$

$$657.19 = 25.9 d^2 + 388.5 d$$

or

$$25.9 d^2 + 388.5 d - 657.19 = 0$$

Solving the above equation gives:

$$d = 1.54 \text{ [m]}$$

The algebraic sum of the forces in Table 5.31 must equate to force in the anchored, Thus, for  $d = 1.54$  [m],  $T = P_{at} - P_p$

$$T = 153.41 - 51.8 d$$

$$T = 153.41 - 51.8 \times 1.54$$

$$T = 73.9 \text{ [kN]}$$

Figure 5.48 shows net earth pressure diagram.

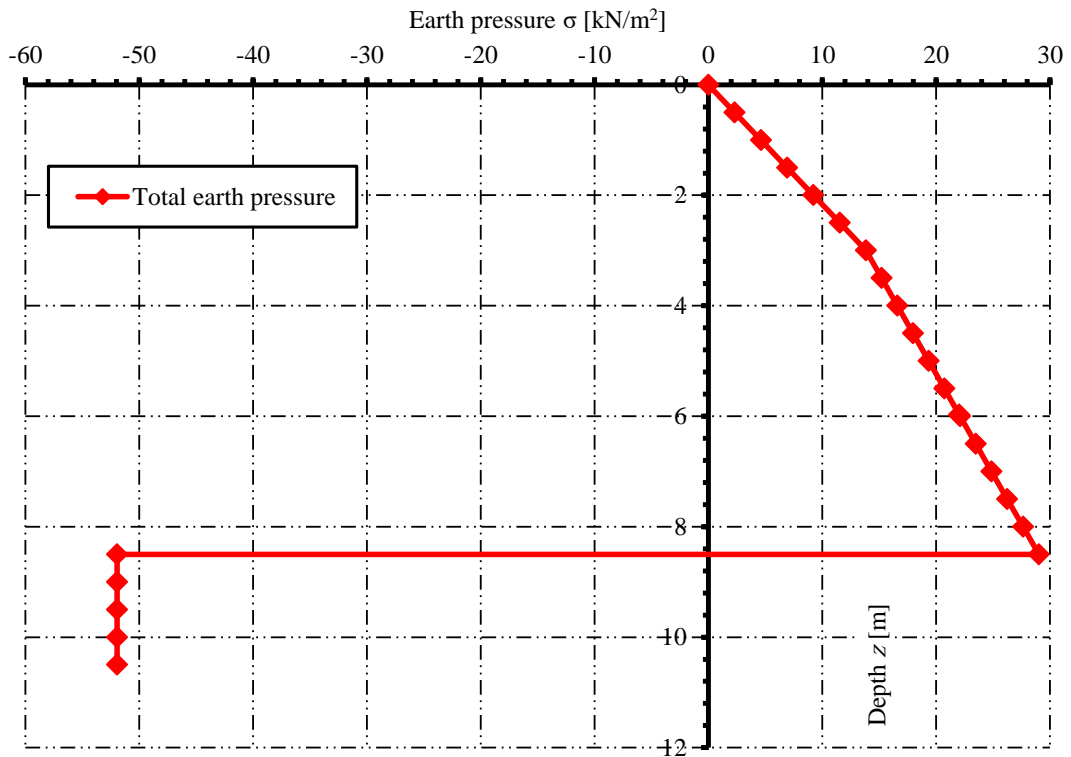

Figure 5.48 Net earth pressures diagram

### 5.5.10.5 Design of sheet pile wall

#### 5.5.10.5.1 Point of zero shear

Point of zero shear is determined from equating active forces and the anchored force  $P_a(y) = T$  at distance  $y$  below the water table, as shown in Figure 5.49. Earth pressures on the pile wall are listed in Table 5.32. Forces, arms, and moments are listed in 0.

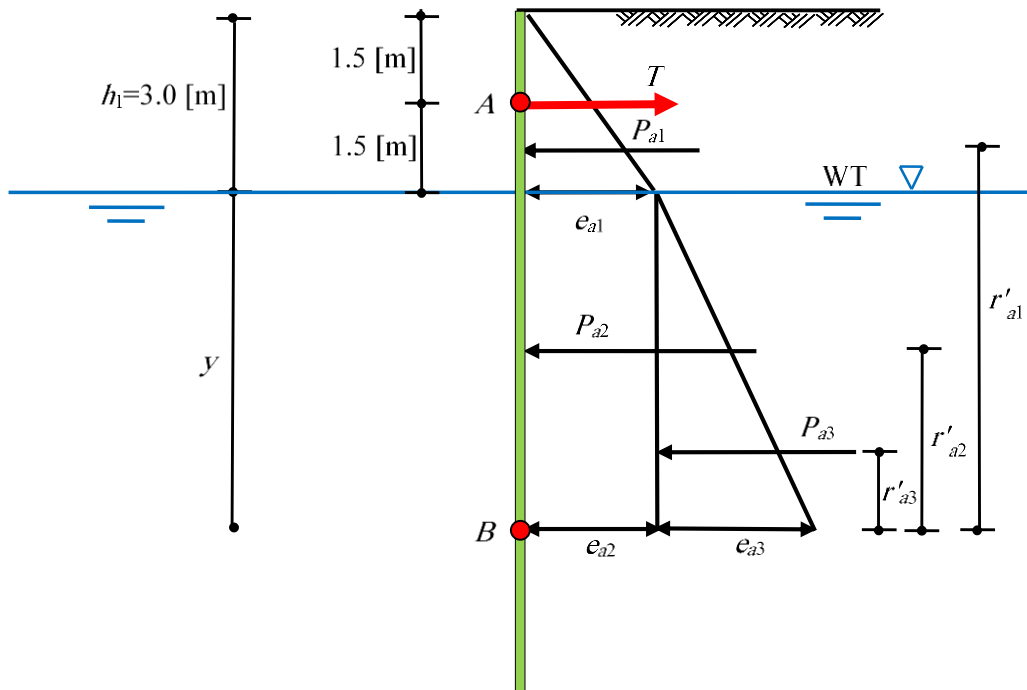

Figure 5.49 Point of zero shear

Table 5.32 Earth pressures on the pile wall

Soil	Earth pressure $e$ [kN/m <sup>2</sup> ]		
Active	$e_{a1} = \gamma_d h_1 k_a$	$= 17 \times 3 \times 0.27$	$= 13.82$
	$e_{a2} = e_{a2}$	$= 17 \times 3 \times 0.27$	$= 13.82$
	$e_{a3} = \gamma_{sub} y k_a$	$= 10.2 \times y \times 0.27$	$= 2.76 y$

Table 5.33 Earth forces on the pile wall and moments about point A

Soil	Force $P$ [kN]	Arm from B $r$ [m]	Moment @ A $M = P \times r$ [kN.m]
Active	$P_{a1} = 0.5 e_{a2} h_1 = 20.73$	$1 + y$	$M_{a1} = 20.73 + 20.73 y$
	$P_{a2} = e_{a3} y = 13.82 y$	$y / 2$	$M_{a2} = 6.91 y^2$

	$P_{a3} = 0.5 e_{a4} y = 1.38 y^2$	$y / 3$	$M_{a3} = 0.46 y^3$
	$P_{at} = \Sigma P_a = 1.38 y^2 + 13.82 y + 20.73$	$M_{at} = \Sigma M_a = 0.46 y^3 + 6.91 y^2 + 20.73 y + 20.73$	
Passive	$P_p = T = 73.9$	$1.5 + y$	$M_{pt} = 110.85 + 73.9 y$

Equating active forces and the anchored force  $P_{at} = T$  at distance  $y$  below the water table

$$1.38 y^2 + 13.82 y + 20.73 = 73.9$$

or

$$1.38 y^2 + 13.82 y - 53.17 = 0$$

Solving the above equation, gives the point of zero shear at distance  $y$  as:

$$y = 2.97 \text{ [m]}$$

Point of zero shear from the ground surface = 5.97 [m]

#### 5.5.10.5.2 Max. Moment

Maximum moment on the wall is calculated in Table 5.24.

Table 5.34 Determining maximum moment  $M_{max}$

Soil	Moment $M = P \times r$ [kN.m]
Active	$M_{at} = 0.46y^3 + 6.91y^2 + 20.73y + 20.73 = 155.11$
Passive	$M_{pt} = 554.25 + 73.9 y = 330.1$
	$M_{max} = M_{at} - M_{pt} = - 174.99$

#### 5.5.10.6 Penetration depth by GEO Tools

The penetration depth obtained by *GEO Tools* for the anchored sheet pile penetrating in clay is equal to that obtained by *Das* (2011) through hand calculation. The input data and results of *GEO Tools* for this example are presented on the next pages.

```

*****
                        GEO Tools
                        Version 12.2
                        Program authors Prof. M. El Gendy/ Dr. A. El Gendy
*****
Title: Anchored sheet pile penetrating in clay by free earth support method
Date: 15-11-2021
Project: Example 9.10, page 484, Principles of Foundation Engineering, Das (2011)
File: Ex09 Anchored SP in clay

```

## Sheet Pile Wall

---

-----  
Anchored sheet pile wall with free earth support  
-----

### Data:

Distributed load	q	[kN/m <sup>2</sup> ]	= 0.00
Safety factor for passive resistance	Fs1	[-]	= 1.00
Safety factor for penetration depth	Fs2	[-]	= 1.00
Depth of dredge line	L1	[m]	= 9.00
Anchor depth	D	[m]	= 1.50

### Soil Data:

Ground water depth-left	Gwl_L	[m]	= 3.00
Ground water depth-right	Gwl_R	[m]	= 3.00

### Layer No.: 1

Cohesion of the soil	C	[kN/m <sup>2</sup> ]	= 0.000
Angle of internal friction	φ	[°]	= 35.00
Dry unit weight of the soil-left	γ <sub>d_L</sub>	[kN/m <sup>3</sup> ]	= 17.00
Saturated unit weight of the soil-left	γ <sub>sat_L</sub>	[kN/m <sup>3</sup> ]	= 20.00
Dry unit weight of the soil-right	γ <sub>d_R</sub>	[kN/m <sup>3</sup> ]	= 17.00
Saturated unit weight of the soil-right	γ <sub>sat_R</sub>	[kN/m <sup>3</sup> ]	= 20.00
Layer thickness	h	[m]	= 9.00

### Layer No.: 2

Cohesion of the soil	C	[kN/m <sup>2</sup> ]	= 41.000
Angle of internal friction	φ	[°]	= 0.00
Dry unit weight of the soil-left	γ <sub>d_L</sub>	[kN/m <sup>3</sup> ]	= 17.00
Saturated unit weight of the soil-left	γ <sub>sat_L</sub>	[kN/m <sup>3</sup> ]	= 20.00
Dry unit weight of the soil-right	γ <sub>d_R</sub>	[kN/m <sup>3</sup> ]	= 17.00
Saturated unit weight of the soil-right	γ <sub>sat_R</sub>	[kN/m <sup>3</sup> ]	= 20.00
Layer thickness	h	[m]	= 5.00

### Result:

Sheet pile length	L	[m]	= 10.53
Minimum sheet pile length	L <sub>m</sub>	[m]	= 10.53
Minimum penetration depth	L <sub>2</sub>	[m]	= 1.53
Resistance force at the toe	R	[kN]	= 0.4
Anchor force	T	[kN]	= 73.8
Maximum moment	M <sub>max</sub>	[kN.m]	= -174.61
Moment arm from the ground surface	Y	[m]	= 5.97

---

 Earth pressures on the sheet pile:
 

---

No.	Depth	Passive earth pressure from soil weight	Water pressure left	Active earth pressure from soil weight	Water pressure right	Earth pressure
I	z	ep	wl	ea	wr	E
[-]	[m]	[kN/m <sup>2</sup> ]	[kN/m <sup>2</sup> ]	[kN/m <sup>2</sup> ]	[kN/m <sup>2</sup> ]	[kN/m <sup>2</sup> ]
1	0.00	0.00	0.00	0.00	0.00	0.00
2	0.50	0.00	0.00	2.30	0.00	2.30
3	1.00	0.00	0.00	4.61	0.00	4.61
4	1.49	0.00	0.00	6.86	0.00	6.86
5	1.50	0.00	0.00	6.91	0.00	6.91
6	1.51	0.00	0.00	6.96	0.00	6.96
7	2.00	0.00	0.00	9.21	0.00	9.21
8	2.50	0.00	0.00	11.52	0.00	11.52
9	3.00	0.00	0.00	13.82	0.00	13.82
10	3.50	0.00	-4.91	15.20	4.91	15.20
11	4.00	0.00	-9.81	16.58	9.81	16.58
12	4.50	0.00	-14.71	17.96	14.71	17.96
13	5.00	0.00	-19.62	19.34	19.62	19.34
14	5.50	0.00	-24.53	20.72	24.53	20.72
15	5.97	0.00	-29.14	22.02	29.14	22.02
16	6.00	0.00	-29.43	22.10	29.43	22.10
17	6.50	0.00	-34.34	23.49	34.34	23.49
18	7.00	0.00	-39.24	24.87	39.24	24.87
19	7.50	0.00	-44.14	26.25	44.14	26.25
20	8.00	0.00	-49.05	27.63	49.05	27.63
21	8.50	0.00	-53.95	29.01	53.95	29.01
22	8.99	0.00	-58.76	30.36	58.76	30.36
23	9.00	-82.10	-58.86	30.14	58.86	-51.96
24	9.01	-82.20	-58.96	30.24	58.96	-51.96
25	9.50	-87.20	-63.76	35.23	63.76	-51.96
26	10.00	-92.29	-68.67	40.33	68.67	-51.96
27	10.50	-97.39	-73.57	45.42	73.57	-51.96
28	10.53	-97.69	-73.87	45.73	73.87	-51.96

---



## Sheet Pile Wall

---

Shear Forces/ Moments:

No. I	Depth z [m]	Shear force Q [kN]	Moment M [kN.m]
1	0.00	0.00	0.00
2	0.50	-0.58	0.10
3	1.00	-2.30	0.77
4	1.49	-5.11	2.54
5	1.50	-5.18	2.59
6	1.51	68.55	1.91
7	2.00	64.59	-30.76
8	2.50	59.41	-61.81
9	3.00	53.08	-89.98
10	3.50	45.82	-114.73
11	4.00	37.88	-135.68
12	4.50	29.24	-152.49
13	5.00	19.91	-164.81
14	5.50	9.90	-172.29
15	5.97	-0.15	-174.61
16	6.00	-0.81	-174.59
17	6.50	-12.21	-171.37
18	7.00	-24.30	-162.27
19	7.50	-37.07	-146.96
20	8.00	-50.54	-125.08
21	8.50	-64.70	-96.30
22	8.99	-79.25	-61.06
23	9.00	-79.14	-60.27
24	9.01	-78.62	-59.48
25	9.50	-53.16	-27.20
26	10.00	-27.18	-7.11
27	10.50	-1.19	-0.02
28	10.53	0.37	-0.01

Sheet pile wall

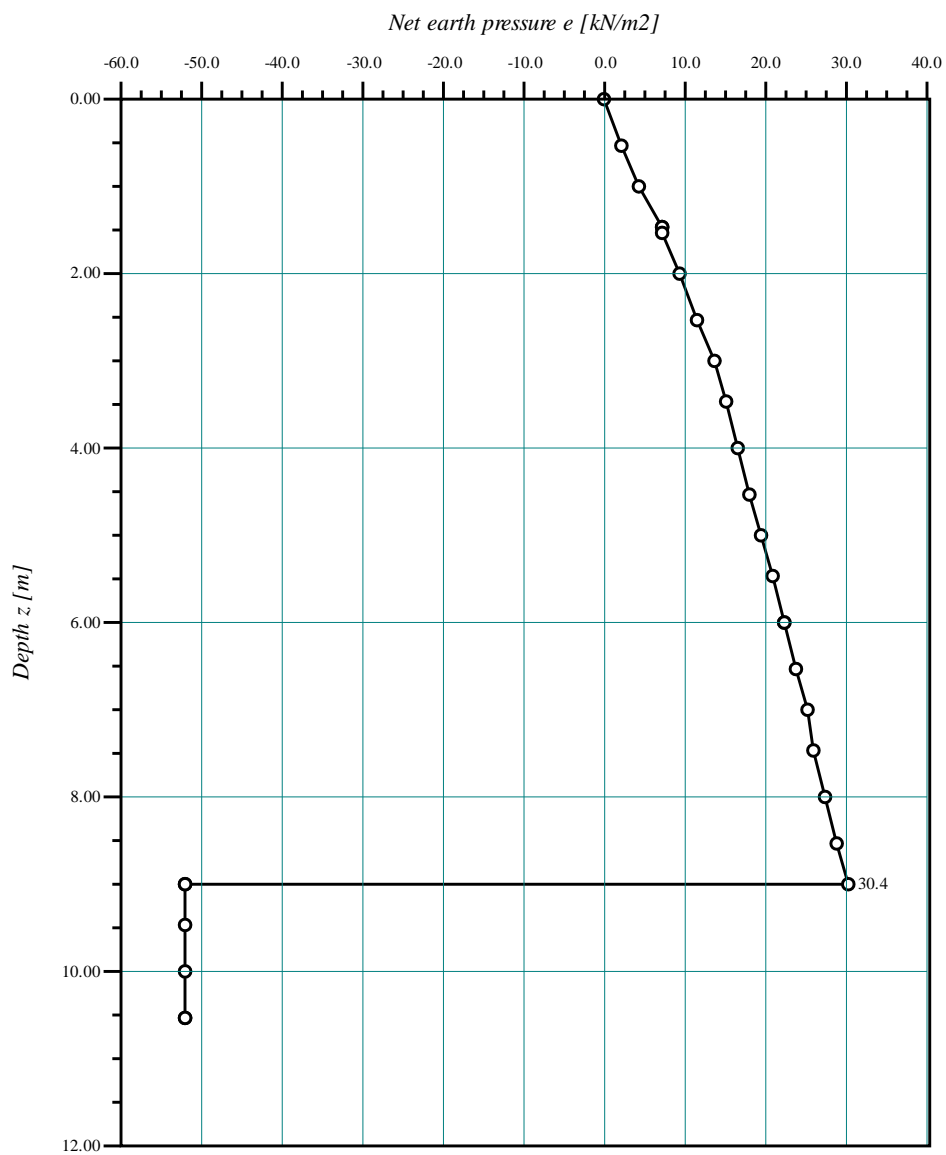

Earth pressures on the sheet pile

GEOTEC Software Inc

PO Box 14001 Richmond Road PO, Calgary AB, Canada T3E 7Y7

Scale: 722

File: Ex09

Page No.:

Project: Example 9.10, page 484, Principles of Foundation Engineering, Das (2011)

Date: 15-11-2021

Title: Anchored sheet pile penetrating in clay by free earth support method

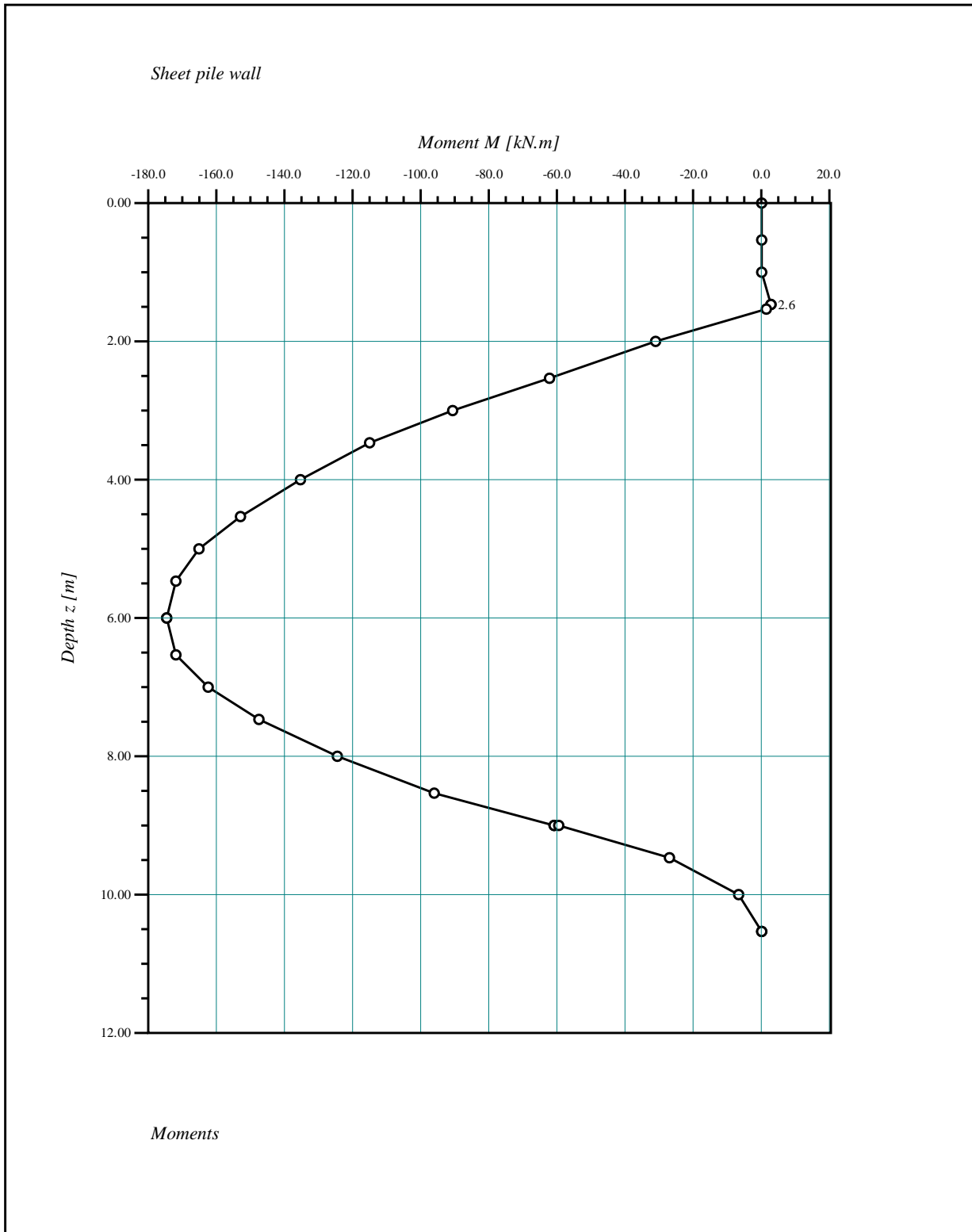

<p><b>GEOTEC Software Inc</b>                  PO Box 14001 Richmond Road PO, Calgary AB, Canada T3E 7Y7</p>	
<p>Scale: 1354                  File: Ex09                  Page No.:</p>	<p>Project: Example 9.10, page 484, Principles of Foundation Engineering, Das (2011)                  Date: 15-11-2021                  Title: Anchored sheet pile penetrating in clay by free earth support method</p>

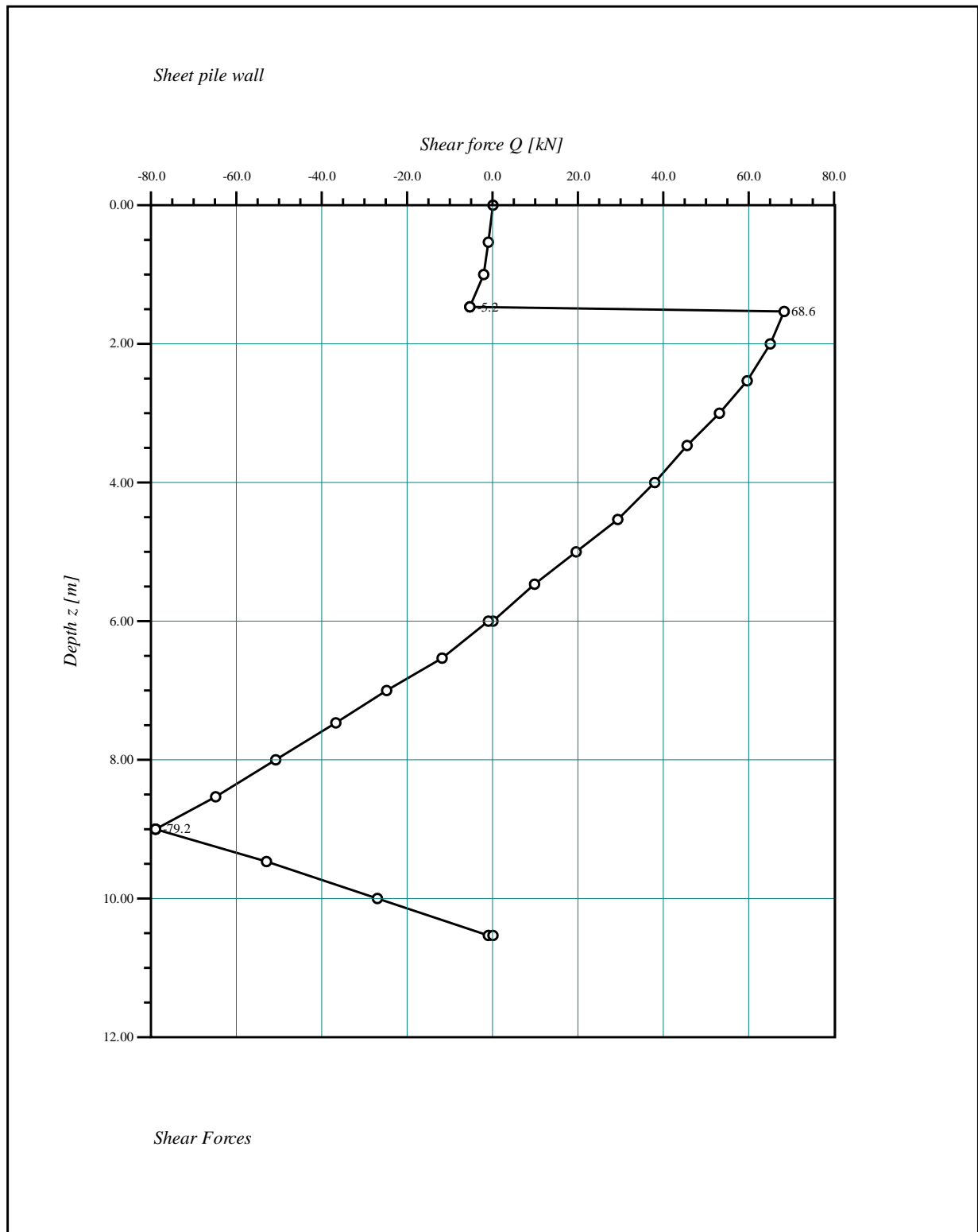

<p><b>GEOTEC Software Inc</b>                  PO Box 14001 Richmond Road PO, Calgary AB, Canada T3E 7Y7</p>	
<p><b>Scale: 1083</b>  <b>File: Ex09</b>  <b>Page No.:</b></p>	<p><b>Project: Example 9.10, page 484, Principles of Foundation Engineering, Das (2011)</b>  <b>Date: 15-11-2021</b>  <b>Title: Anchored sheet pile penetrating in clay by free earth support method</b></p>

**5.5.11 Example 10: Anchored sheet pile penetrating  $c$ -  $\phi$  soil**

**5.5.11.1 Description of the problem**

To verify the analysis of anchored sheet pile penetrating in  $c$ -  $\phi$  soil, the theoretical penetration depth  $d$  for the given anchored sheet pile penetrating in  $c$ -  $\phi$  soil in Figure 5.50 obtained by *Al-Agha* (2015), Problem (1) page 237, through hand calculation using free earth support method is compared with that obtained by *GEO Tools*. The unit weight and shear parameters of the soil layers are shown in Figure 5.50.

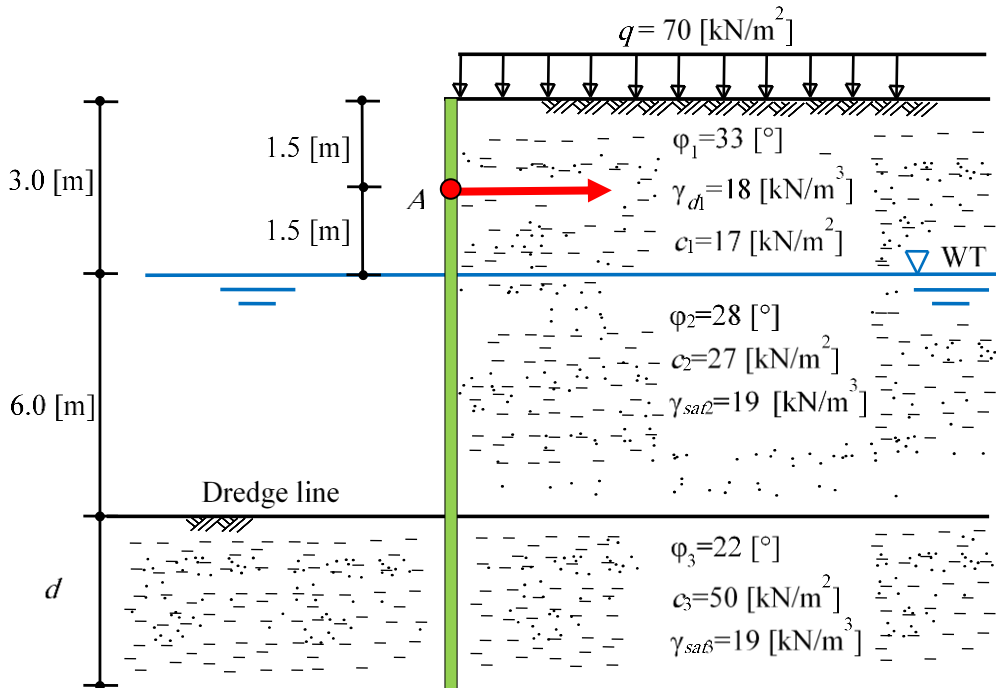

Figure 5.50 Anchored sheet pile penetrating in clay

**5.5.11.2 Soil parameters and earth pressure coefficients**

First layer:

Dry unit weight of the soil	$\gamma_{d1}$	= 18	[kN/m <sup>3</sup> ]
Angle of internal friction of the soil	$\phi_1$	= 33	[°]
Cohesion of the soil	$c_1$	= 17	[kN/m <sup>2</sup> ]
Active earth pressure coefficient	$k_{a1}$	= $(1 - \sin \phi) / (1 + \sin \phi) = 0.30$	

Second layer:

Saturated unit weight of the soil	$\gamma_{sat2}$	= 19	[kN/m <sup>3</sup> ]
Submerged unit weight of the soil	$\gamma_{Sub2}$	= $19 - 9.81 = 9.19$	[kN/m <sup>3</sup> ]
Angle of internal friction of the soil	$\phi_2$	= 28	[°]
Cohesion of the soil	$c_2$	= 27	[kN/m <sup>2</sup> ]
Active earth pressure coefficient	$k_{a2}$	= $(1 - \sin \phi) / (1 + \sin \phi) = 0.36$	

Third layer:

Saturated unit weight of the soil	$\gamma_{sat3}$	= 19	[kN/m <sup>3</sup> ]
Submerged unit weight of the soil	$\gamma_{Sub3}$	= $19 - 9.81 = 9.19$	[kN/m <sup>3</sup> ]
Angle of internal friction of the soil	$\phi_3$	= 22	[°]
Cohesion of the soil	$c_3$	= 50	[kN/m <sup>2</sup> ]
Active earth pressure coefficient	$k_{a3}$	= $(1 - \sin \phi) / (1 + \sin \phi) = 0.46$	
Passive earth pressure coefficient	$k_{p3}$	= $1 / k_{a3} = 2.20$	

5.5.11.3 Determining earth pressures, forces and moments on the wall

The design dimensions and the earth pressure diagrams are shown in Figure 5.51. The procedure is to equate moments about A, the position of the anchored. Earth pressures on the pile wall are listed in Table 5.35. Forces, arms, and moments are listed in Table 5.36. The water levels on the two sides of the wall are equal. Therefore, the hydrostatic pressure distributions are in balance and can be eliminated from the calculations.

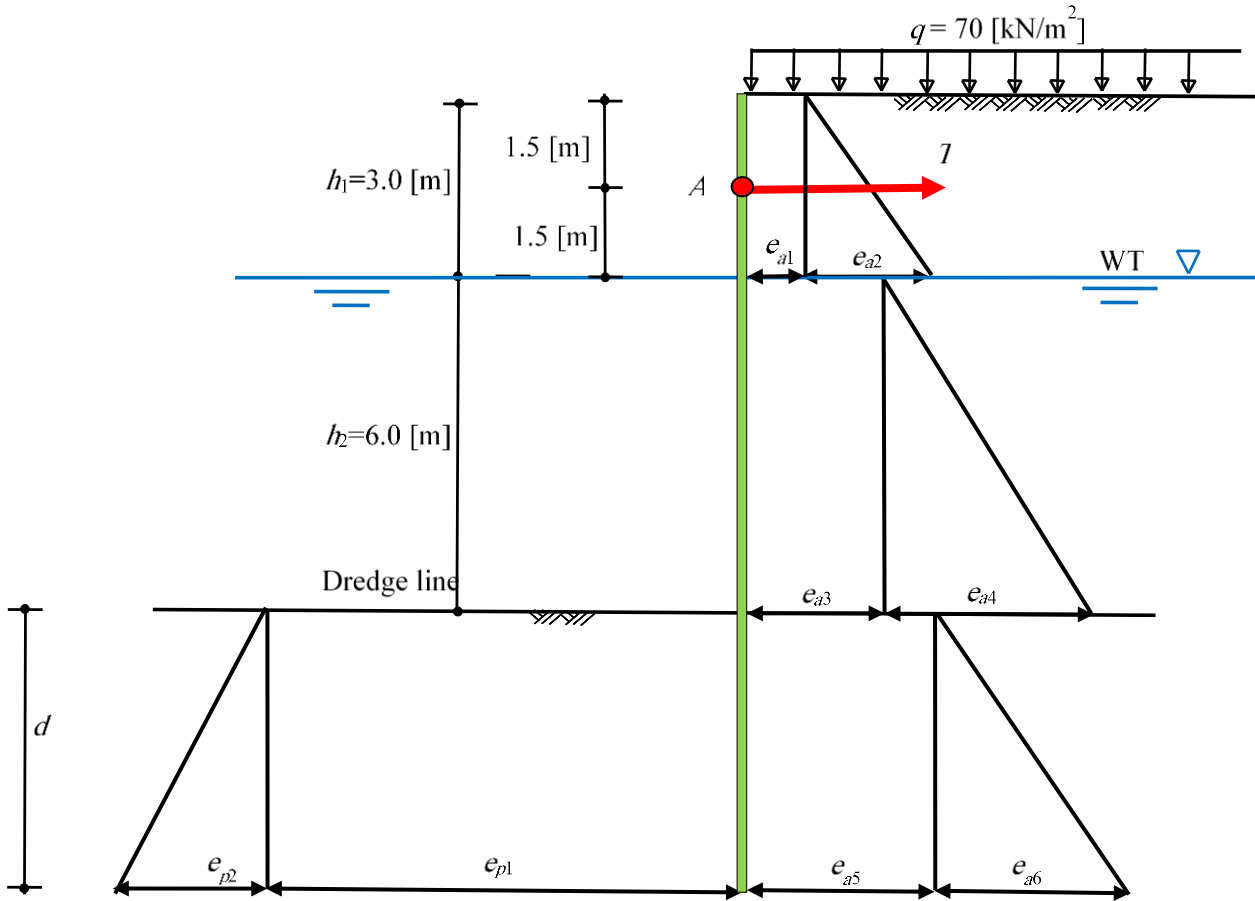

Figure 5.51 Earth pressures diagrams

In the analysis, it is convenient to obtain the net earth pressure distribution under the dredge line. This is done by subtracting the active earth pressure from the passive earth pressure under the dredge line. Figure 5.52 shows the net earth pressure diagrams.

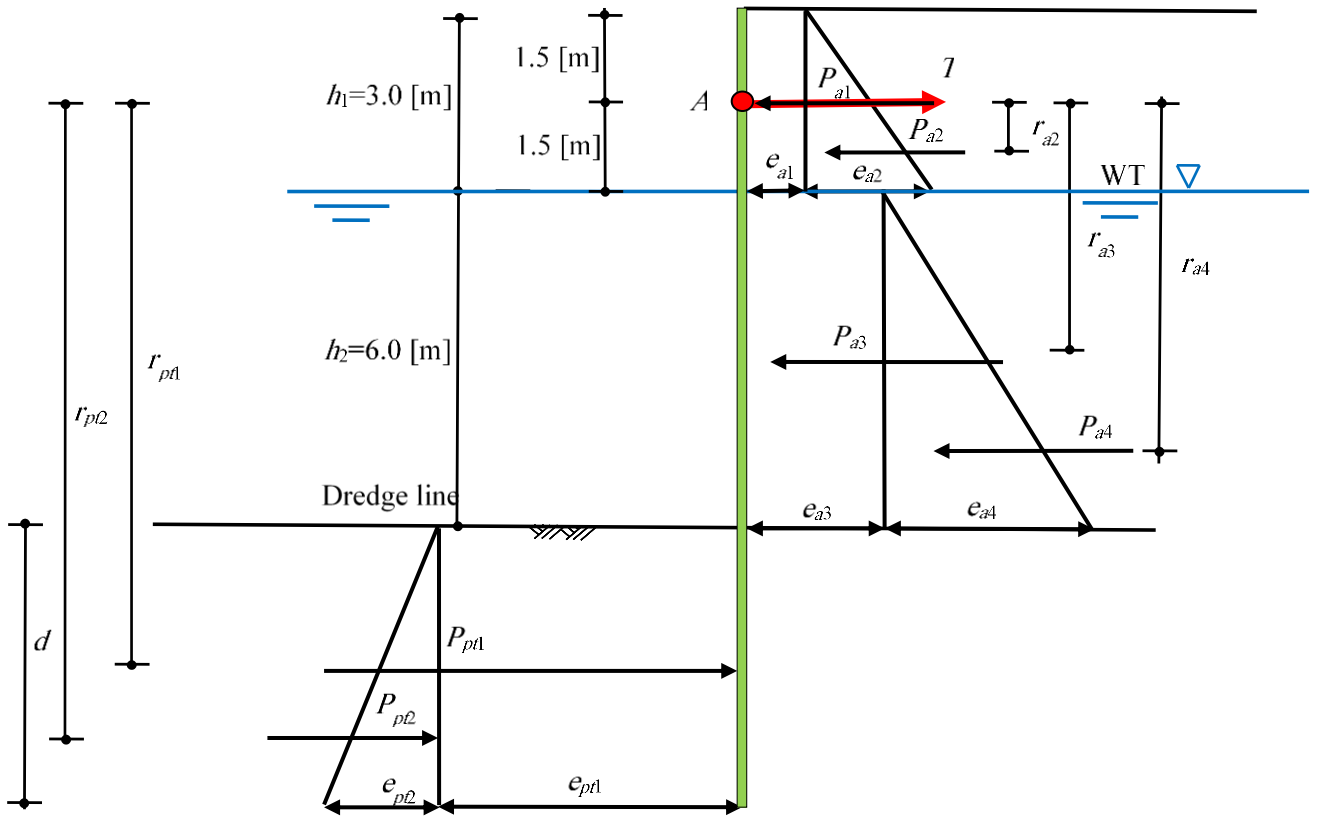

Figure 5.52 Net earth pressures diagrams

Table 5.35 Earth pressures on the pile wall

Soil	Earth pressure $e$ [kN/m <sup>2</sup> ]		
Active	$e_{a1} = q k_{a1} - 2 c_1 \sqrt{k_{a1}}$	$= 70 \times 0.3 - 2 \times 17 \sqrt{0.3}$	$= 2.18$
	$e_{a2} = \gamma_{d1} h_1 k_{a1}$	$= 18 \times 3 \times 0.3$	$= 15.93$
	$e_{a3} = (q + \gamma_{d1} h_1) k_{a2} - 2 c_1 \sqrt{k_{a2}}$	$= (70 + 18 \times 3) \times 0.36 - 2 \times 27 \sqrt{0.36}$	$= 12.32$
	$e_{a4} = \gamma_{sub2} h_2 k_{a2}$	$= 9.19 \times 6 \times 0.36$	$= 19.91$
	$e_{a5} = (q + \gamma_{d1} h_1 + \gamma_{sub1} h_2) k_{a3}$	$= (70 + 18 \times 3 + 9.19 \times 6) \times 0.46$	$= 14.06$
	$e_{a6} = e_{a4} + \gamma_{sub3} d k_{a3}$	$= 9.19 \times d \times 0.46$	$= 4.18 d$
Passive	$e_{p1} = 2 c_3 \sqrt{k_{p3}}$	$= 2 \times 50 \sqrt{2.2}$	$= 148.26$
	$e_{p2} = \gamma_{sub3} d k_{p3}$	$= 9.19 \times d \times 2.2$	$= 20.2 d$
Net	$e_{pt1} = e_{p1} - e_{a5}$	$= 148.26 - 14.06$	$= -134.2 (-)$
passive	$e_{pt2} = e_{p2} - e_{a6}$	$= 20.2 d - 4.18 d$	$= -16.02 d (-)$

Table 5.36 Earth forces on the pile wall and moments about point A

Soil	Force $P$ [kN]	Arm from A $r$ [m]	Moment @ $o$ $M = P \times r$ [kN.m]
Active	$P_{a1} = e_{a1} h_1 = 6.55$	0	$M_{a1} = 0$
	$P_{a2} = 0.5 e_{a2} h_1 = 23.9$	0.5	$M_{a2} = 11.95$
	$P_{a3} = e_{a3} h_2 = 73.91$	4.5	$M_{a3} = 332.61$
	$P_{a4} = 0.5 e_{a4} h_2 = 59.72$	5.5	$M_{a4} = 328.45$
	$P_{at} = \Sigma P_a = 164.08$		$M_{at} = \Sigma M_a = 673.01$
Passive	$P_{p1} = e_{p1} d = 134.26 d (-)$	$7.5 + d/2$	$M_{p1} = 67.13 d^2 + 1006.95 d (-)$
	$P_{p2} = e_p d = 8.01 d^2 (-)$	$7.5 + 2d/3$	$M_{p2} = 5.34 d^3 + 60.08 d^2 (-)$
	$P_{pt} = \Sigma P_p = 8.01 d^2 + 134.26 d (-)$		$M_{pt} = \Sigma M_p = 5.34 d^3 + 127.21 d^2 + 1006.95 d (-)$

#### 5.5.11.4 Determining penetration depth and pile length

Equating active and passive moments about A,  $M_{at} = M_{pt}$

$$673.01 = 5.34 d^3 + 127.21 d^2 + 1006.95 d$$

or

$$5.34 d^3 + 127.21 d^2 + 1006.95 d - 673.01 = 0$$

Solving the above equation gives:

$$d = 0.62 \text{ [m]}$$

The algebraic sum of the forces in Table 5.36 must equate to force in the anchored, Thus, for  $d = 0.62$  [m],  $T = P_{at} - P_{pt}$

$$T = 164.08 - 8.01 d^2 + 134.26 d$$

$$T = 164.08 - 8.01 \times 0.62^2 - 134.26 \times 0.62$$

$$T = 77.9 \text{ [kN]}$$



**5.5.11.5 Design of sheet pile wall**

**5.5.11.5.1 Point of zero shear**

Point of zero shear is determined from equating active force and anchored force  $P_a(y) = T$  at point  $s$  at distance  $y$  from the water table, Figure 5.53.

$$P_{a1} + P_{a2} + e_{a3} y + 0.5 \gamma_{sub2} y k_{a2} y = T$$

$$6.55 + 23.9 + 12.32 y + 0.5 \times 9.19 \times 0.36 y^2 = 77.9$$

or

$$1.66 y^2 + 12.32 y - 47.46 = 0$$

Solving the above equation, gives the point of zero shear at distance  $y$  as:

$$y = 2.8 \text{ [m]}$$

$$\text{Moment arm from the ground surface} = 2.8 + 3 = 5.8 \text{ [m]}$$

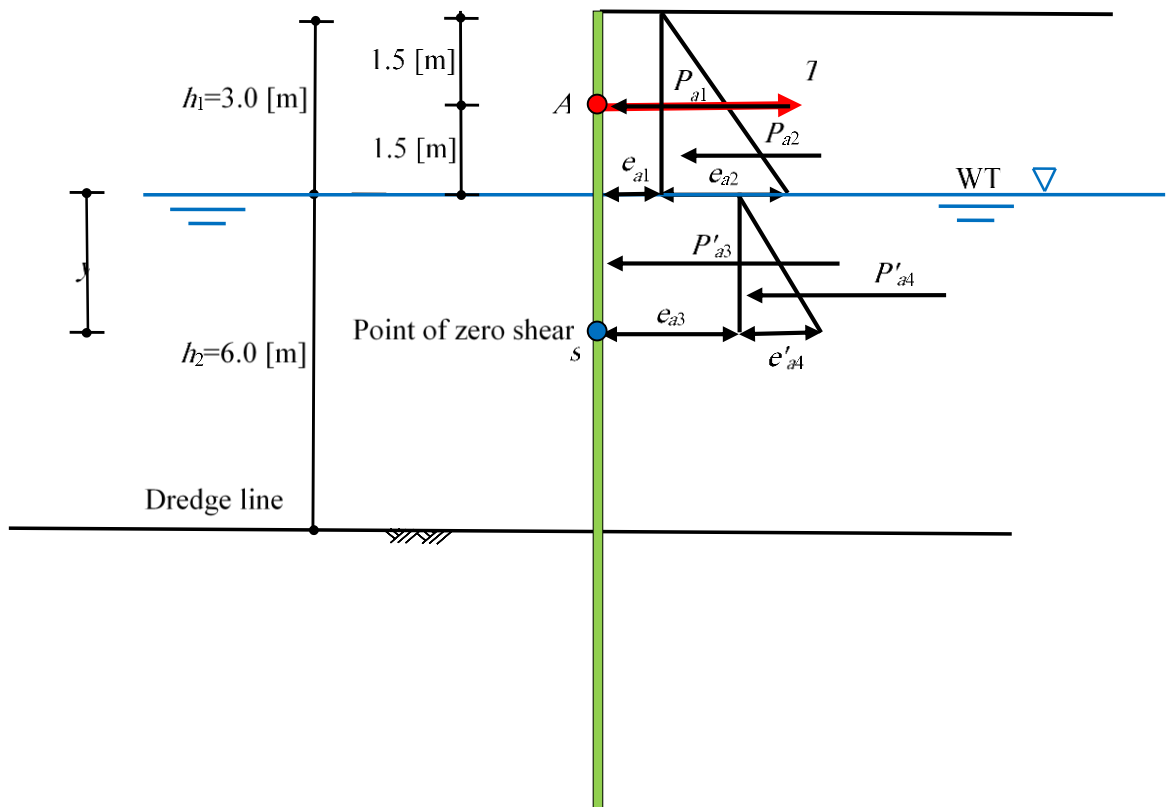

Figure 5.53 Point of zero shear

5.5.11.5.2 Max. Moment

Maximum moment at point  $s$  on the wall is calculated in Table 5.37.

Table 5.37 Determining maximum moment  $M_{max}$  at point  $s$

Force $P$ [kN]	Arm from $A$ $s$ [m]	Moment @ $s$ $M = P \times r$ [kN.m]
$P_{a1} = 6.55$	4.3	$M_1 = 28.15$
$P_{a2} = 23.9$	3.8	$M_2 = 90.75$
$P_{a3} = 12.32$ $y = 34.47$	1.4	$M_3 = 48.22$
$P_{a4} = 1.66$ $y^2 = 12.99$	0.93	$M_4 = 12.12$
$T = -77.9$	4.3	$M_5 = -334.81$
$P_t = \Sigma P_a = 0$		$M_{at} = \Sigma M_a = -155.57$

Figure 5.54 shows net earth pressure diagram.

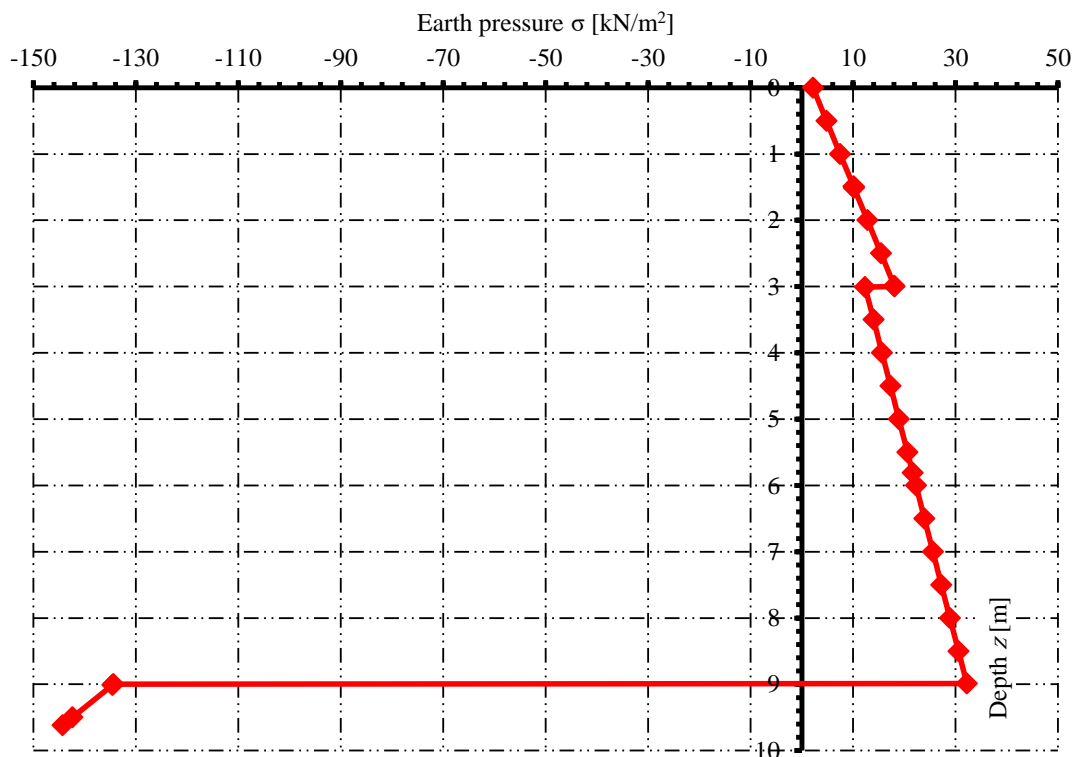

Figure 5.54 Net earth pressures diagram

5.5.11.6 Penetration depth by GEO Tools

The penetration depth obtained by *GEO Tools* for the anchored sheet pile penetrating in  $c$ -  $\phi$  soil is equal to that obtained by *Al-Agha* (2015) through hand calculation. The input data and results of *GEO Tools* for this example are presented on the next pages.

# Sheet Pile Wall

\*\*\*\*\*

GEO Tools  
Version 12.2

Program authors Prof. M. El Gendy/ Dr. A. El Gendy

\*\*\*\*\*

Title: Anchored sheet pile penetrating c- fhi soil

Date: 18/11/2021

Project: Al-Agha (2015), Problem 1, page 237

File: Ex10 Anchored SP in c- fhi soil

-----  
Anchored sheet pile wall with free earth support  
-----

## Data:

Distributed load	q	[kN/m2]	= 70.00
Safety factor for passive resistance	Fs1	[-]	= 1.00
Safety factor for penetration depth	Fs2	[-]	= 1.00
Depth of dredge line	L1	[m]	= 9.00
Anchor depth	D	[m]	= 1.50

## Soil Data:

Ground water depth-left	Gwl_L	[m]	= 3.00
Ground water depth-right	Gwl_R	[m]	= 3.00

## Layer No.: 1

Cohesion of the soil	C	[kN/m2]	= 17.000
Angle of internal friction	$\phi$	[°]	= 33.00
Dry unit weight of the soil-left	$\gamma_{d\_L}$	[kN/m3]	= 18.00
Saturated unit weight of the soil-left	$\gamma_{sat\_L}$	[kN/m3]	= 18.00
Dry unit weight of the soil-right	$\gamma_{d\_R}$	[kN/m3]	= 18.00
Saturated unit weight of the soil-right	$\gamma_{sat\_R}$	[kN/m3]	= 18.00
Layer thickness	h	[m]	= 3.00

## Layer No.: 2

Cohesion of the soil	C	[kN/m2]	= 27.000
Angle of internal friction	$\phi$	[°]	= 28.00
Dry unit weight of the soil-left	$\gamma_{d\_L}$	[kN/m3]	= 19.00
Saturated unit weight of the soil-left	$\gamma_{sat\_L}$	[kN/m3]	= 19.00
Dry unit weight of the soil-right	$\gamma_{d\_R}$	[kN/m3]	= 19.00
Saturated unit weight of the soil-right	$\gamma_{sat\_R}$	[kN/m3]	= 19.00
Layer thickness	h	[m]	= 6.00

## Layer No.: 3

Cohesion of the soil	C	[kN/m2]	= 50.000
Angle of internal friction	$\phi$	[°]	= 22.00
Dry unit weight of the soil-left	$\gamma_{d\_L}$	[kN/m3]	= 19.00
Saturated unit weight of the soil-left	$\gamma_{sat\_L}$	[kN/m3]	= 19.00
Dry unit weight of the soil-right	$\gamma_{d\_R}$	[kN/m3]	= 19.00
Saturated unit weight of the soil-right	$\gamma_{sat\_R}$	[kN/m3]	= 19.00
Layer thickness	h	[m]	= 3.00

## Result:

Sheet pile length	L	[m]	= 9.62
Minimum sheet pile length	Lm	[m]	= 9.62
Minimum penetration depth	L2	[m]	= 0.62
Resistance force at the toe	R	[kN]	= 1.0
Anchor force	T	[kN]	= 77.9
Maximum moment	Mmax	[kN.m]	= -155.49
Moment arm from the ground surface	Y	[m]	= 5.81

---

 Earth pressures on the sheet pile:
 

---

No.	Depth	Passive earth pressure from soil weight	Water pressure left wl	Active earth pressure from surcharge eq	Active earth pressure from soil weight ea	Water pressure right wr	Earth pressure E
I	z	ep	wl	eq	ea	wr	E
[-]	[m]	[kN/m <sup>2</sup> ]	[kN/m <sup>2</sup> ]	[kN/m <sup>2</sup> ]	[kN/m <sup>2</sup> ]	[kN/m <sup>2</sup> ]	[kN/m <sup>2</sup> ]
1	0.00	0.00	0.00	20.64	-18.46	0.00	2.18
2	0.50	0.00	0.00	20.64	-15.81	0.00	4.83
3	1.00	0.00	0.00	20.64	-13.15	0.00	7.48
4	1.49	0.00	0.00	20.64	-10.55	0.00	10.08
5	1.50	0.00	0.00	20.64	-10.50	0.00	10.14
6	1.51	0.00	0.00	20.64	-10.45	0.00	10.19
7	2.00	0.00	0.00	20.64	-7.85	0.00	12.79
8	2.50	0.00	0.00	20.64	-5.19	0.00	15.44
9	2.99	0.00	0.00	20.64	-2.59	0.00	18.04
10	3.00	0.00	0.00	20.64	-2.54	0.00	18.09
11	3.01	0.00	-0.10	25.27	-12.92	0.10	12.35
12	3.50	0.00	-4.91	25.27	-11.29	4.91	13.98
13	4.00	0.00	-9.81	25.27	-9.63	9.81	15.64
14	4.50	0.00	-14.71	25.27	-7.97	14.71	17.30
15	5.00	0.00	-19.62	25.27	-6.31	19.62	18.96
16	5.50	0.00	-24.53	25.27	-4.66	24.53	20.62
17	5.81	0.00	-27.57	25.27	-3.63	27.57	21.65
18	6.00	0.00	-29.43	25.27	-3.00	29.43	22.28
19	6.50	0.00	-34.34	25.27	-1.34	34.34	23.93
20	7.00	0.00	-39.24	25.27	0.32	39.24	25.59
21	7.50	0.00	-44.14	25.27	1.98	44.14	27.25
22	8.00	0.00	-49.05	25.27	3.64	49.05	28.91
23	8.50	0.00	-53.95	25.27	5.30	53.95	30.57
24	8.99	0.00	-58.76	25.27	6.92	58.76	32.20
25	9.00	-148.46	-58.86	31.85	-17.80	58.86	-134.41
26	9.01	-148.66	-58.96	31.85	-17.75	58.96	-134.57
27	9.50	-158.56	-63.76	31.85	-15.70	63.76	-142.42
28	9.62	-160.98	-64.94	31.85	-15.20	64.94	-144.34

---

## Sheet Pile Wall

---

Shear Forces/ Moments:

No. I	Depth z [m]	Shear force Q [kN]	Moment M [kN.m]
1	0.00	0.00	0.00
2	0.50	-1.75	0.38
3	1.00	-4.83	1.97
4	1.49	-9.13	5.34
5	1.50	-9.23	5.43
6	1.51	68.53	4.75
7	2.00	62.90	-27.51
8	2.50	55.84	-57.25
9	2.99	47.64	-82.65
10	3.00	47.46	-83.13
11	3.01	47.31	-83.60
12	3.50	40.85	-105.23
13	4.00	33.45	-123.84
14	4.50	25.21	-138.54
15	5.00	16.15	-148.92
16	5.50	6.26	-154.56
17	5.81	-0.29	-155.49
18	6.00	-4.47	-155.04
19	6.50	-16.02	-149.96
20	7.00	-28.40	-138.89
21	7.50	-41.61	-121.42
22	8.00	-55.65	-97.14
23	8.50	-70.52	-65.63
24	8.99	-85.90	-27.34
25	9.00	-85.39	-26.48
26	9.01	-84.05	-25.63
27	9.50	-16.19	-0.92
28	9.62	1.02	-0.01

Sheet pile wall

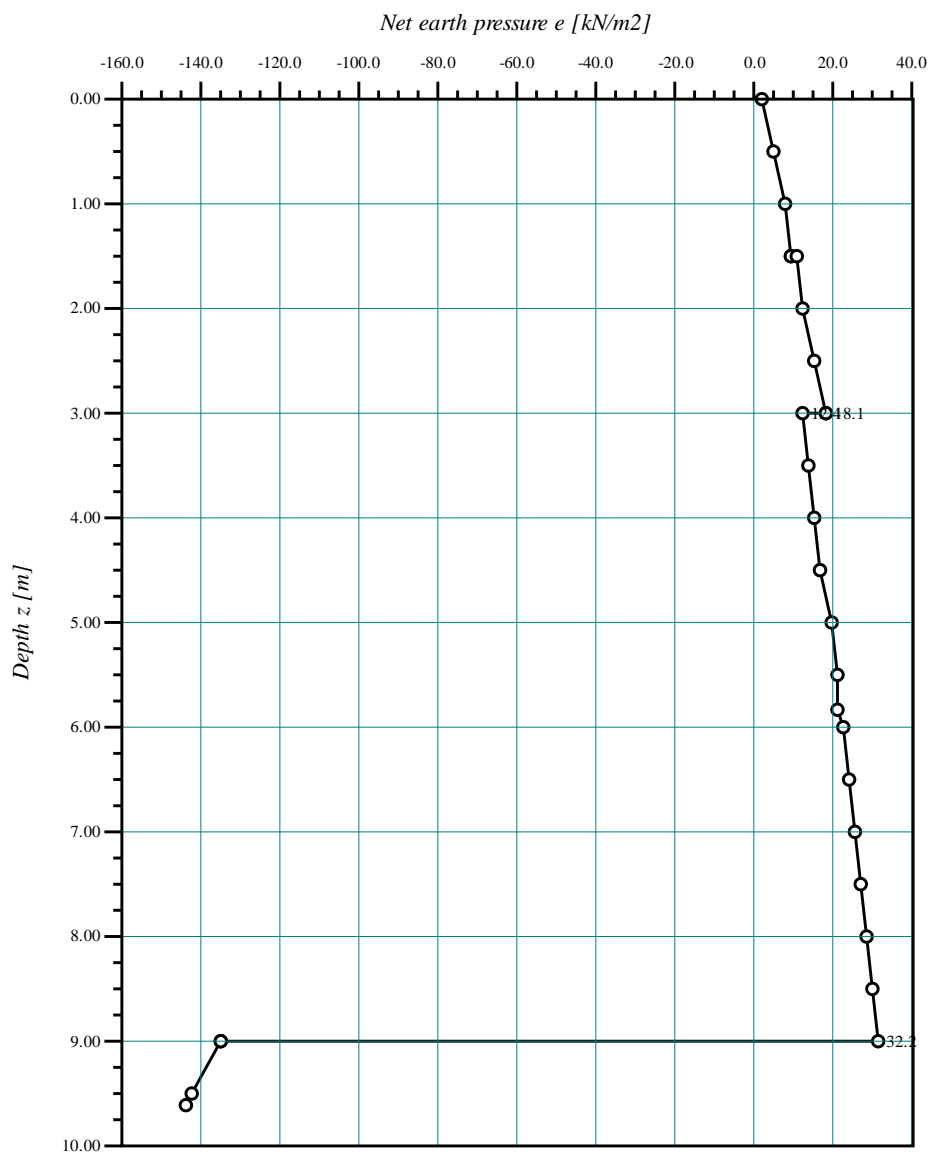

Earth pressures on the sheet pile

GEOTEC Software Inc

PO Box 14001 Richmond Road PO, Calgary AB, Canada T3E 7Y7

Scale: 1473

File: Ex10

Page No.:

Project: Al-Agha (2015), Problem 1, page 237

Date: 18/11/2021

Title: Anchored sheet pile penetrating c- ? soil

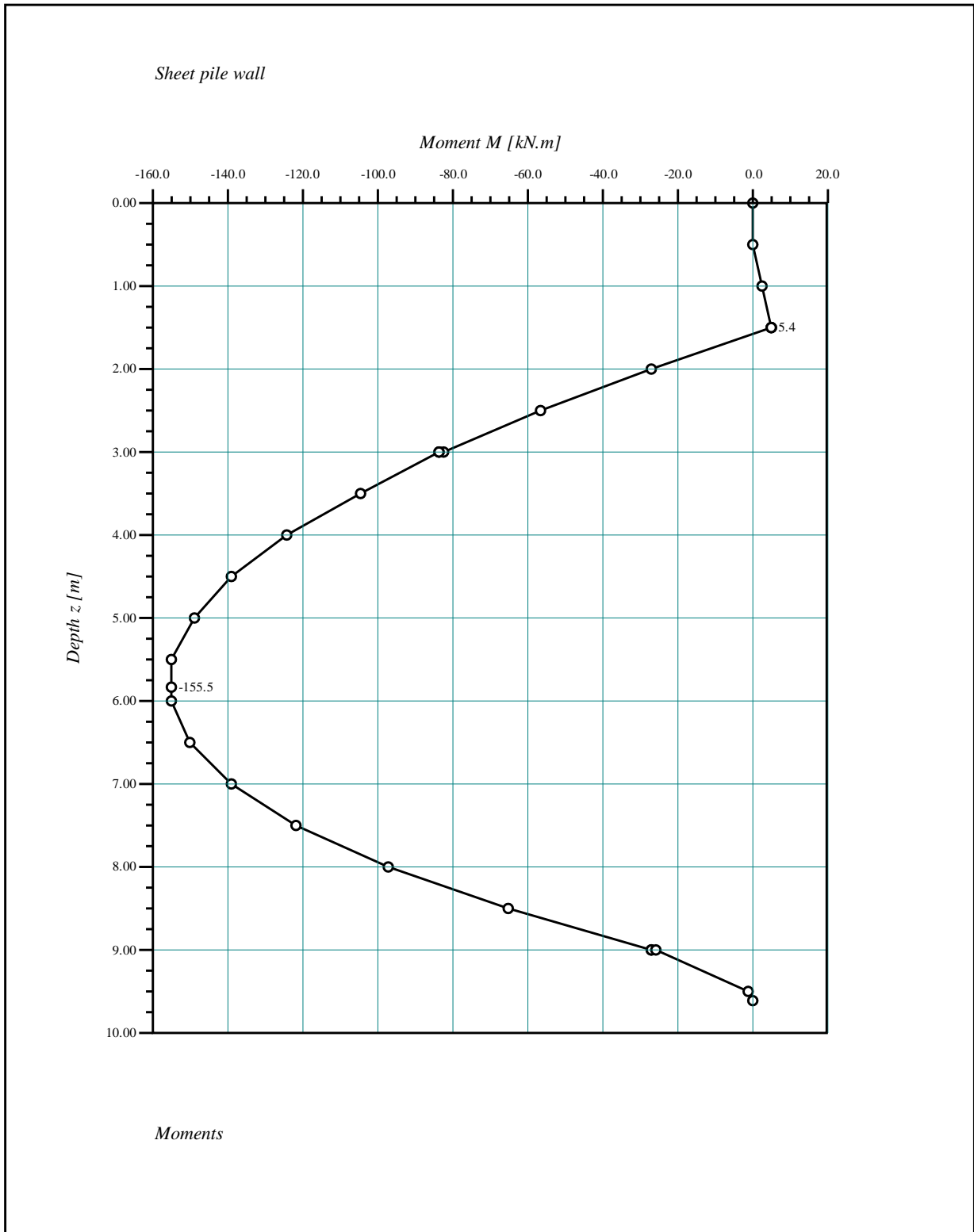

<p><b>GEOTEC Software Inc</b>                  PO Box 14001 Richmond Road PO, Calgary AB, Canada T3E 7Y7</p>	
<p>Scale: 1231                  File: Ex10                  Page No.:</p>	<p>Project: Al-Agha (2015), Problem 1, page 237                  Date: 18/11/2021                  Title: Anchored sheet pile penetrating c- ? soil</p>

Sheet pile wall

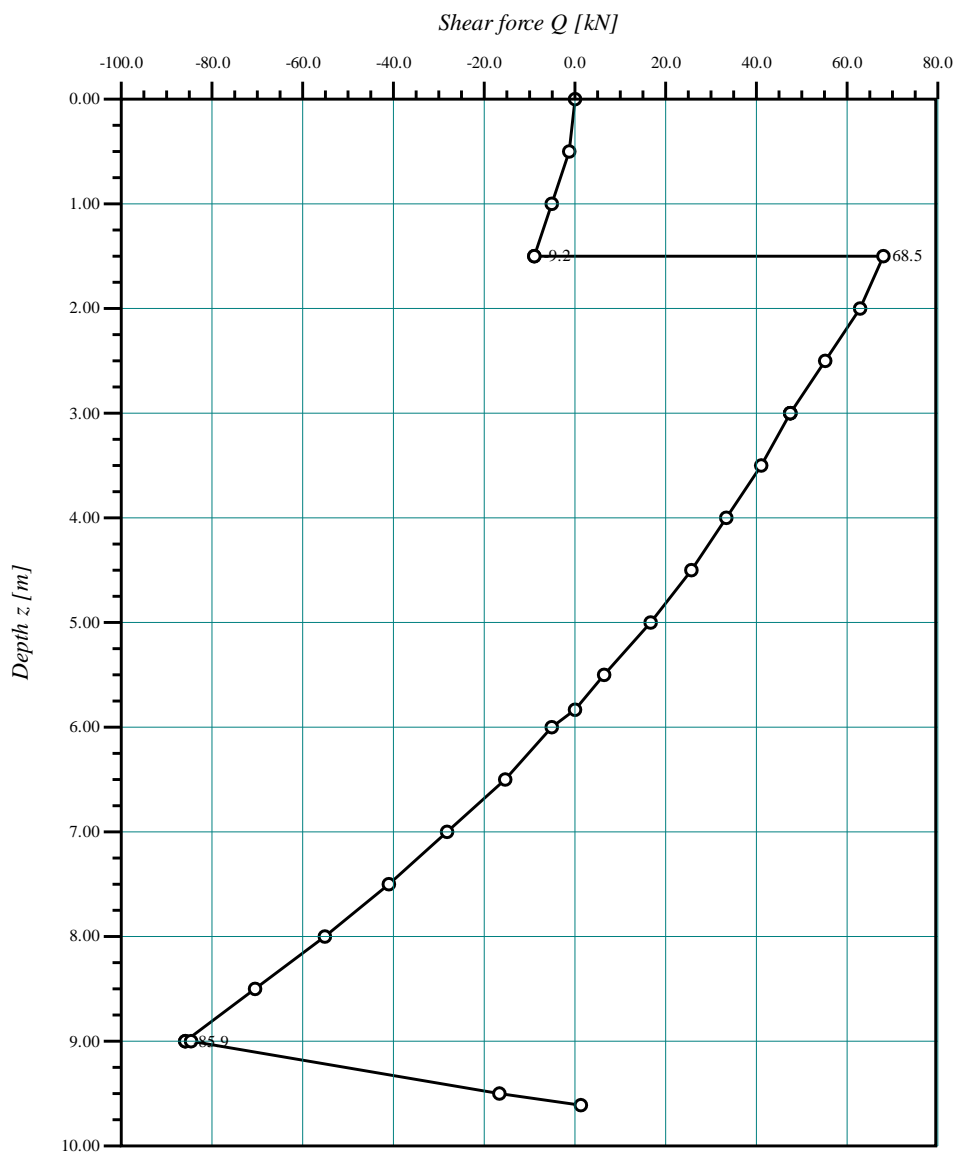

Shear Forces

GEOTEC Software Inc

PO Box 14001 Richmond Road PO, Calgary AB, Canada T3E 7Y7

Scale: 1282

File: Ex10

Page No.:

Project: Al-Agha (2015), Problem 1, page 237

Date: 18/11/2021

Title: Anchored sheet pile penetrating c- ? soil



**5.5.12 Example 11: Anchored sheet pile penetrating in sand by EBM**

**5.5.12.1 Description of the problem**

To verify the analysis of an anchored sheet pile wall in the sand, the maximum moment  $M_{max}$ , theoretical penetration depth  $d$ , and the anchor force  $T$  for the given anchored sheet pile wall in Figure 5.55 obtained by *Das* (2011), Example (9.9) page 477, using the equivalent beam method (EBM) is compared with that obtained by *GEO Tools*.

The side of an excavation 9.15 [m] deep in the sand is to be supported by an anchored sheet pile wall. The anchor is at a depth of 1.53 [m] from the surface. The water table is 3.05 [m] below the ground surface. The unit weight of the sand above the water table is  $\gamma_d = 16$  [kN/m<sup>3</sup>], and the saturated unit weight is  $\gamma_{sat} = 19.5$  [kN/m<sup>3</sup>] below the water table. Shear parameters are  $c = 0$  [kN/m<sup>2</sup>] and  $\phi = 30$  [°]. Take a factor of safety for the penetration depth = 20%.

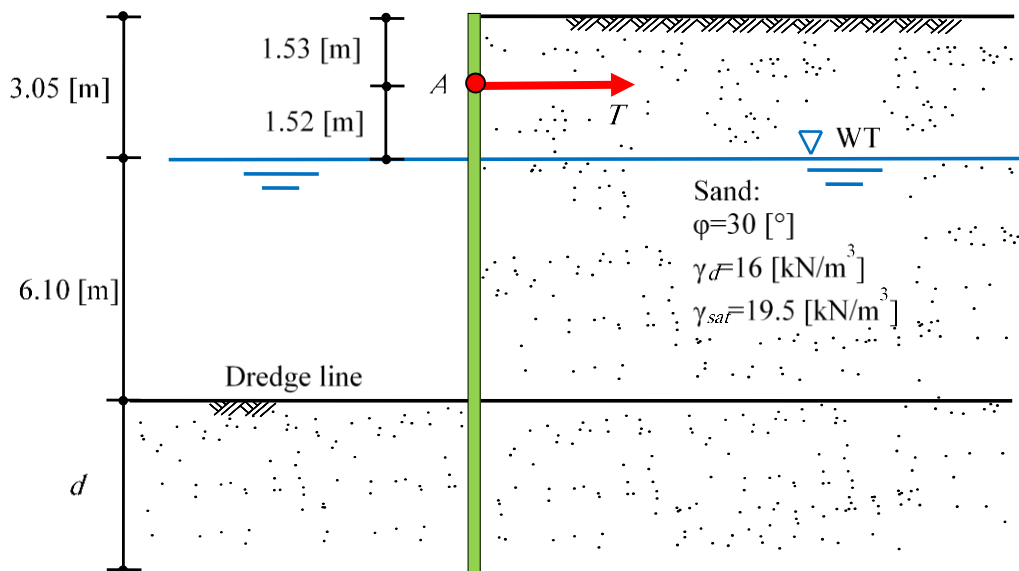

Figure 5.55 Anchored sheet pile penetrating in sand

**5.5.12.2 Soil parameters and earth pressure coefficients**

Dry unit weight of the soil	$\gamma_d$	= 16 [kN/m <sup>3</sup> ]
Saturated unit weight of the soil	$\gamma_{sat}$	= 19.5 [kN/m <sup>3</sup> ]
Submerged unit weight of the soil	$\gamma_{Sub}$	= 19.5 – 9.81 = 9.69 [kN/m <sup>3</sup> ]
Angle of internal friction	$\phi$	= 30 [°]

Active earth pressure coefficient	$k_a$	= (1 – sin $\phi$ ) / (1 + sin $\phi$ ) = 1 / 3
Passive earth pressure coefficient	$k_p$	= (1 + sin $\phi$ ) / (1 – sin $\phi$ ) = 3

**5.5.12.3 Determining earth pressures, forces and moments on the wall**

Figure 5.55 shows the design dimensions and the earth pressure diagrams for the equivalent beam shown in Figure 5.56 and Figure 5.57. For  $\phi = 30$  [°],  $y = 0.08 h = 0.08 \times 9.15 = 0.73$  [m]

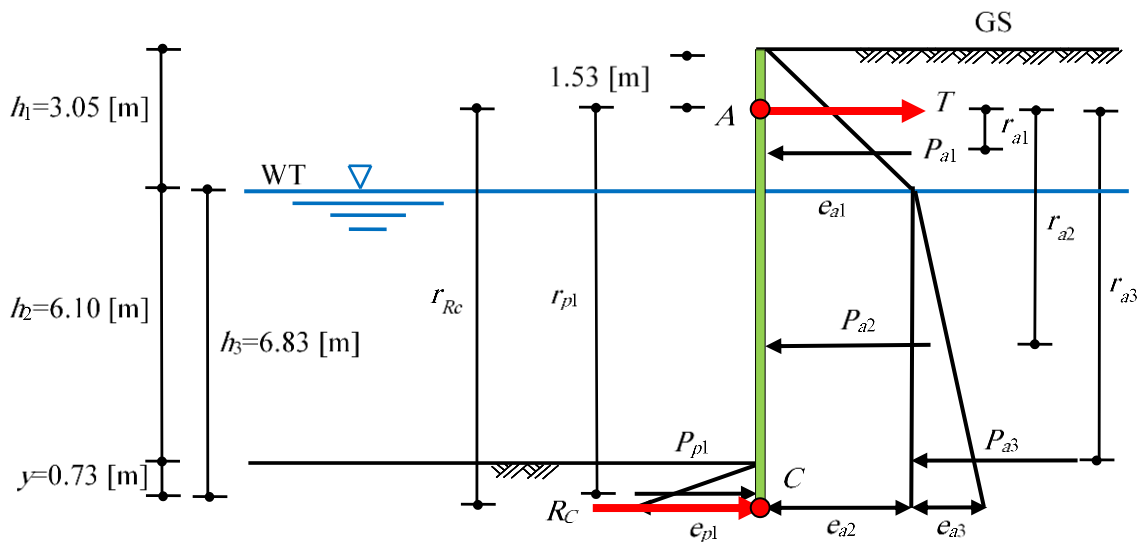

Figure 5.56 Upper beam

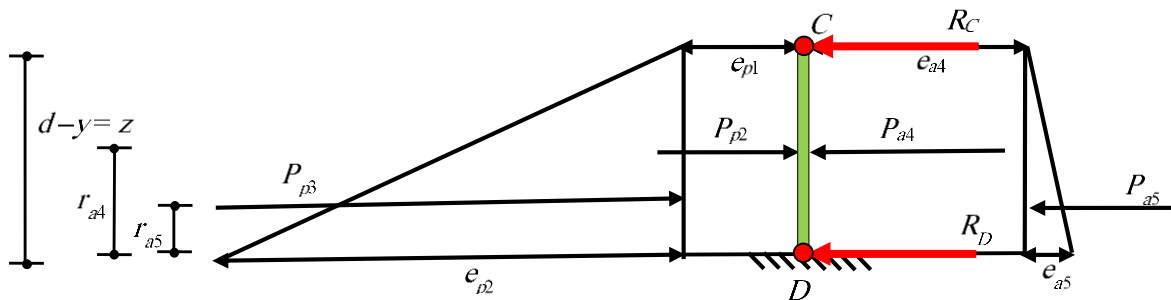

Figure 5.57 Lower beam

Consider the upper beam, for equilibrium, the algebraic sum of the moments of the forces about A, the position of the anchor, must be zero. Earth pressures on the upper beam are listed in Table 5.38. Forces, arms, and moments are listed in Table 5.39. The water levels on the two sides of the wall are equal. Therefore, the hydrostatic pressure distributions are in balance and can be eliminated from the calculations.

Table 5.38 Earth pressures on upper beam

Soil	Earth pressure $e$ [kN/m <sup>2</sup> ]		
Active	$e_{a1} = \gamma_d h_1 k_a$	$= 16 \times 3.05 \times 1/3$	$= 16.27$
	$e_{a2} = e_{a1}$	$= 16.27$	$= 16.27$
	$e_{a3} = \gamma_{sub} h_3 k_a$	$= 9.69 \times 6.83 \times 1/3$	$= 22.06$
Passive	$e_{p1} = \gamma_{sub} y k_p$	$= 9.69 \times 0.73 \times 3$	$= 21.22$

Table 5.39 Earth forces on the upper beam and moments about point A

Soil	Force $P$ [kN]	Arm from A $r$ [m]	Moment @ A $M = P \times r$ [kN.m]
Active	$P_{a1} = 0.5 e_{a1} h_1 = 24.81$	0.5	$M_{a1} = 12.41$
	$P_{a2} = e_{a2} h_3 = 111.12$	4.94	$M_{a2} = 548.93$
	$P_{a3} = 0.5 e_{a3} h_3 = 75.33$	6.07	$M_{a3} = 457.25$
	$P_{atu} = \Sigma P_a = 211.26$		$M_{atu} = \Sigma M_a = 1018.59$
Passive	$P_{p1} = 0.5 e_{p1} y = 7.75$	8.11	$M_{ptu} = 62.85 (-)$
Reaction	$R_C$	8.35	$M_{Rc} = 8.35 R_C (-)$

**5.5.12.4 Determining the force  $R_C$**

Take the bending moment at the anchor position A. Thus, by equating active and passive moments about A,  $M_{atu} - M_{ptu} - M_{RC} = 0$

$$1018.53 - 67.54 - 8.35 R_C = 0$$

Solving the above equation gives:

$$R_C = 114.46 \text{ [kN]}$$

In addition, for equilibrium, the algebraic sum of the forces in Table 5.39 must equate to force in the anchored,  $T = P_{at} - P_p - R_C$ :

$$T = 211.26 - 7.75 - 114.46$$

$$T = 89.05 \text{ [kN]}$$

**5.5.12.5 Determining penetration depth  $d$**

Consider, now, the lower beam, the length of the beam is  $(d - y) = z$ . For equilibrium, the algebraic sum of the moments of the forces about  $D$  must be zero. Earth pressures on the lower beam are listed in Table 5.40. Forces, arms, and moments are listed in Table 5.41. The water levels on the two sides of the wall are equal. Therefore, the hydrostatic pressure distributions are in balance and can be eliminated from the calculations.

Table 5.40 Earth pressures on the lower beam

Soil	Earth pressure $e$ [kN/m <sup>2</sup> ]		
Active	$e_{a4} = e_{a2} + e_{a3}$	$= 16.27 + 22.06$	$= 38.33$
	$e_{a5} = \gamma_{sub} z k_a$	$= 9.69 \times z \times 1/3$	$= 3.23 z$
Passive	$e_{p1} = 21.22$	$= 21.22$	$= 21.22$
	$e_{p2} = \gamma_{sub} z k_p$	$= 9.69 \times z \times 3$	$= 29.07 z$

Table 5.41 Earth forces on the lower beam and moments about point D

Soil	Force $P$ [kN]	Arm from A $r$ [m]	Moment @ D $M = P \times r$ [kN.m]
Active	$P_{a4} = e_{a4} z = 38.33 z$	$z/2$	$M_{a2} = 19.17 z^2$
	$P_{a5} = 0.5 e_{a5} z = 1.62 z^2$	$z/3$	$M_{a3} = 0.54 z^3$
	$P_{atl} = \Sigma P_a = 1.62 z^2 + 38.33 z$		
Passive	$P_{p2} = e_{p1} z = 21.22 z$	$z/2$	$M_{p2} = 10.61 z^2 (-)$
	$P_{p3} = 0.5 e_{p2} z = 14.54 z^2$	$z/3$	$M_{p3} = 4.85 z^3 (-)$
	$P_{ptl} = \Sigma P_p = 14.54 z^2 + 21.22 z$		
Reaction	$R_C = 114.46$	$z$	$M_{RC} = 114.46 z$

Thus:

$$-4.31 z^3 + 8.56 z^2 + 114.46 z = 0$$

or

$$-4.31 z^2 + 8.56 z + 114.46 = 0$$

The solution is:

$$z = 6.24$$

$$i.e. \quad d = 6.24 + 0.73 = 6.97 \text{ [m]}$$

Min penetration depth  $L_2 = 6.97 \text{ [m]}$

Factor of safety for penetration depth = 20%. Therefore, the penetration depth with an additional 20% is:

Penetration depth  $d_p = 1.2 \times L_2 = 1.2 \times 6.97 = 8.36$  [m]

Pile wall length  $L = h_3 + d_p = 9.15 + 8.36 = 17.51$  [m]

$$R_d = P_{pt} - P_{at} - R_C$$

$$R_d = 14.54 z^2 + 21.22 z - 1.62 z^2 - 38.33 z - 114.46 = 278.34$$
 [kN]

**5.5.12.6 Design of sheet pile wall**

**5.5.12.6.1 Point of zero shear**

Point of zero shear is determined from equating active and passive forces and anchored force  $P_a(y) = P_p(y) + T$  at point  $s$  at distance  $y$  from the water table, Figure 5.58.

$$P_{atu} + P_{atl} = P_{p1} + P_{ptl} + T$$

$$211.26 + 1.62 y^2 + 38.33 y = 7.75 + 14.54 y^2 + 21.22 y + 89.61$$

$$12.92 y^2 + 17.11 y - 114.46 = 0$$

Solving the above equation, gives the point of zero shear at distance  $y$  as:

$$y = 3.71$$
 [m]

Moment arm from the ground surface =  $3.05 + 6.1 + 0.73 + 3.71 = 13.59$  [m]

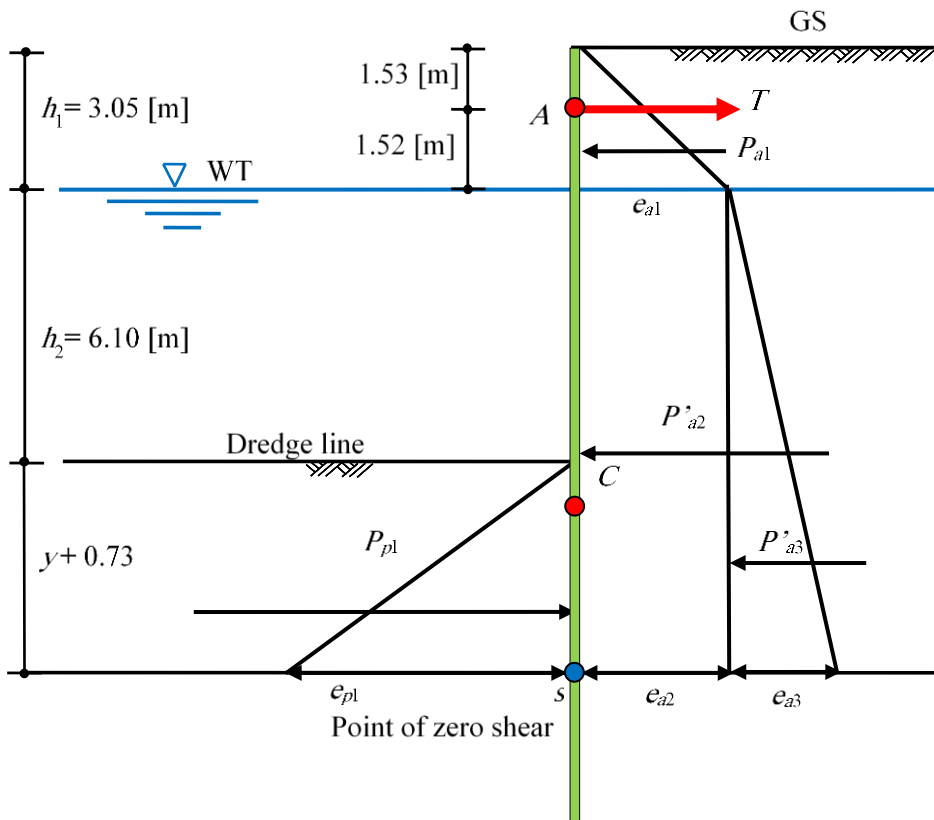

Figure 5.58 Point of zero shear

5.5.12.6.2 Max. Moment

Maximum moment at point  $s$  on the wall is calculated in Table 5.42.

Table 5.42 Determining maximum moment  $M_{max}$  at point  $s$

Force $P$ [kN]	Arm from $A$ $s$ [m]	Moment @ $s$ $M = P \times r$ [kN.m]
$P_{a1} = 24.81$	11.56	$M_1 = 286.8$
$P'_{a2} = 16.27 \times (6.83 + y) = 171.49$	5.27	$M_2 = 903.75$
$P'_{a3} = 1.62 \times (6.83 + y)^2 = 179.97$	3.51	$M_3 = 631.7$
$T = -89.61$	12.06	$M_4 = -1080.7$
$P'a_t = \Sigma P_a = 286.66$		$M'_{at} = \Sigma M_a = 741.55$
$P'p_t = 14.54 \times (0.73 + y)^2 = 286.64$	1.48	$M'_p = 424.23 (-)$
$M_{max} = M'_{at} - M'_p = 317.32$		

Figure 5.59 shows earth pressure diagrams in a single view.

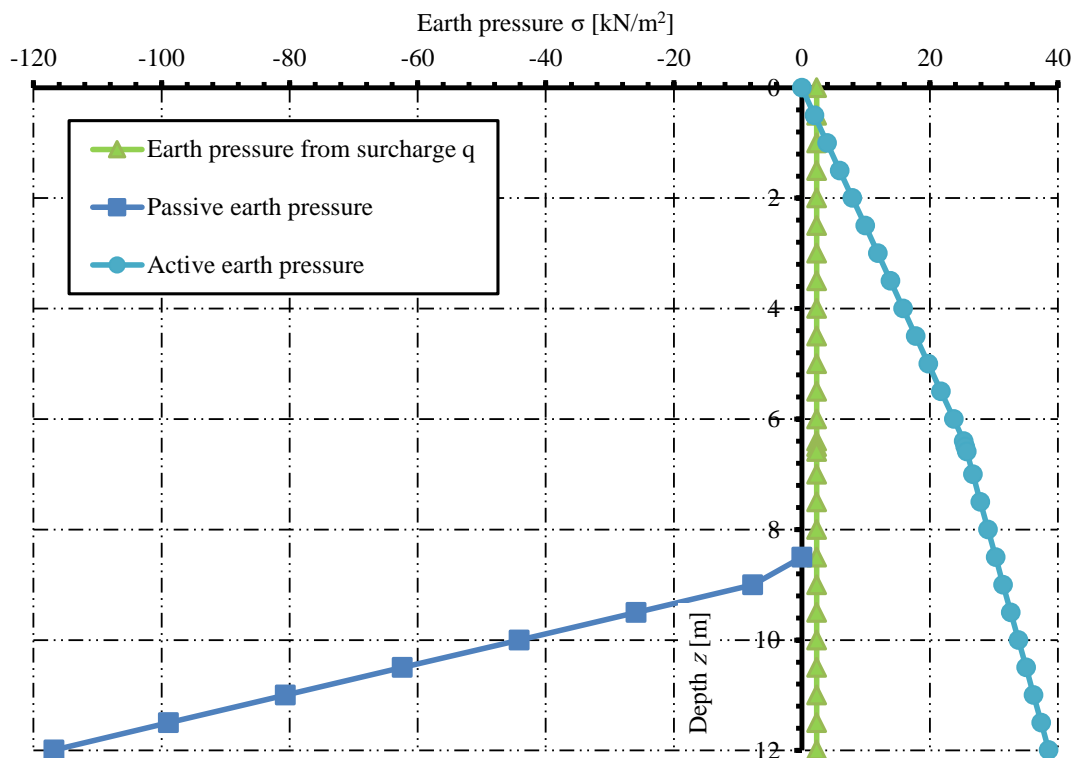

Figure 5.59 Earth pressures diagrams

**5.5.12.7 Penetration depth by *GEO Tools***

The penetration depth obtained by *GEO Tools* for the anchored sheet pile in the sand is equal to that obtained by *Craig* (2012) through hand calculation. The input data and results of *GEO Tools* for this example are presented on the next pages.

\*\*\*\*\*

GEO Tools  
Version 12.2

Program authors Prof. M. El Gendy/ Dr. A. El Gendy

\*\*\*\*\*

Title: Anchored sheet pile penetrating in sand by EBM

Date: 07/11/2021

Project: Example 9.9, page 477, Principles of Foundation Engineering, Das (2011)

File: Ex11 Anchored SP in sand by EBM

-----  
Anchored sheet pile wall with fixed earth support (Equivalent beam method)  
-----

## Data:

Distributed load	q	[kN/m <sup>2</sup> ]	= 0.00
Safety factor for passive resistance	Fs1	[-]	= 1.00
Safety factor for penetration depth	Fs2	[-]	= 1.20
Depth of dredge line	L1	[m]	= 9.15
Anchor depth	D	[m]	= 1.53

## Soil Data:

Ground water depth-left	Gwl_L	[m]	= 3.05
Ground water depth-right	Gwl_R	[m]	= 3.05

## Layer No.: 1

Cohesion of the soil	C	[kN/m <sup>2</sup> ]	= 0.000
Angle of internal friction	φ	[°]	= 30.00
Dry unit weight of the soil-left	γ <sub>d_L</sub>	[kN/m <sup>3</sup> ]	= 16.00
Saturated unit weight of the soil-left	γ <sub>sat_L</sub>	[kN/m <sup>3</sup> ]	= 19.50
Dry unit weight of the soil-right	γ <sub>d_R</sub>	[kN/m <sup>3</sup> ]	= 16.00
Saturated unit weight of the soil-right	γ <sub>sat_R</sub>	[kN/m <sup>3</sup> ]	= 19.50
Layer thickness	h	[m]	= 20.00

## Result:

Sheet pile length	L	[m]	= 17.48
Minimum sheet pile length	L <sub>m</sub>	[m]	= 16.09
Minimum penetration depth	L <sub>2</sub>	[m]	= 6.94
Resistance force at the toe	R	[kN]	= 279.6
Anchor force	T	[kN]	= 89.0
Reaction force on the hinge of the upper beam	R <sub>c</sub>	[kN]	= 114.3
Maximum moment	M <sub>max</sub>	[kN.m]	= 319.85
Moment arm from the ground surface	Y	[m]	= 13.58



## Sheet Pile Wall

Earth pressures on the sheet pile:

No.	Depth	Passive earth pressure from soil weight	Water pressure left	Active earth pressure from soil weight	Water pressure right	Earth pressure
I	z	ep	wl	ea	wr	E
[-]	[m]	[kN/m <sup>2</sup> ]	[kN/m <sup>2</sup> ]	[kN/m <sup>2</sup> ]	[kN/m <sup>2</sup> ]	[kN/m <sup>2</sup> ]
1	0.00	0.00	0.00	0.00	0.00	0.00
2	0.50	0.00	0.00	2.67	0.00	2.67
3	1.00	0.00	0.00	5.33	0.00	5.33
4	1.50	0.00	0.00	8.00	0.00	8.00
5	1.52	0.00	0.00	8.11	0.00	8.11
6	1.53	0.00	0.00	8.16	0.00	8.16
7	1.54	0.00	0.00	8.21	0.00	8.21
8	2.00	0.00	0.00	10.67	0.00	10.67
9	2.50	0.00	0.00	13.33	0.00	13.33
10	3.00	0.00	0.00	16.00	0.00	16.00
11	3.05	0.00	0.00	16.27	0.00	16.27
12	3.50	0.00	-4.41	17.72	4.41	17.72
13	4.00	0.00	-9.32	19.34	9.32	19.34
14	4.50	0.00	-14.22	20.95	14.22	20.95
15	5.00	0.00	-19.13	22.57	19.13	22.57
16	5.50	0.00	-24.03	24.18	24.03	24.18
17	6.00	0.00	-28.94	25.80	28.94	25.80
18	6.50	0.00	-33.84	27.41	33.84	27.41
19	7.00	0.00	-38.75	29.03	38.75	29.03
20	7.50	0.00	-43.65	30.64	43.65	30.64
21	8.00	0.00	-48.56	32.26	48.56	32.26
22	8.50	0.00	-53.46	33.87	53.46	33.87
23	9.00	0.00	-58.37	35.49	58.37	35.49
24	9.14	0.00	-59.74	35.94	59.74	35.94
25	9.15	-0.29	-59.84	35.97	59.84	35.68
26	9.16	-0.58	-59.94	36.00	59.94	35.42
27	9.50	-10.47	-63.27	37.10	63.27	26.64
28	10.00	-25.00	-68.18	38.72	68.18	13.72
29	10.50	-39.54	-73.08	40.33	73.08	0.80
30	11.00	-54.07	-77.99	41.95	77.99	-12.12
31	11.50	-68.61	-82.89	43.56	82.89	-25.05
32	12.00	-83.14	-87.80	45.18	87.80	-37.97
33	12.50	-97.68	-92.70	46.79	92.70	-50.89
34	13.00	-112.21	-97.61	48.41	97.61	-63.81
35	13.50	-126.75	-102.51	50.02	102.51	-76.73
36	13.58	-129.07	-103.30	50.28	103.30	-78.79
37	14.00	-141.28	-107.42	51.63	107.42	-89.65
38	14.50	-155.82	-112.32	53.25	112.32	-102.57
39	15.00	-170.35	-117.23	54.86	117.23	-115.49
40	15.50	-184.89	-122.13	56.48	122.13	-128.41
41	16.00	-199.42	-127.04	58.09	127.04	-141.33
42	16.09	-202.04	-127.92	58.39	127.92	-143.65

## Shear Forces/ Moments:

No. I	Depth z [m]	Shear force Q [kN]	Moment M [kN.m]
1	0.00	0.00	0.00
2	0.50	-0.67	0.11
3	1.00	-2.67	0.89
4	1.50	-6.00	3.00
5	1.52	-6.16	3.12
6	1.53	-6.24	3.18
7	1.54	82.71	2.36
8	2.00	78.37	-34.74
9	2.50	72.37	-72.47
10	3.00	65.03	-106.88
11	3.05	64.23	-110.11
12	3.50	56.58	-137.32
13	4.00	47.32	-163.33
14	4.50	37.25	-184.50
15	5.00	26.37	-200.44
16	5.50	14.68	-210.74
17	6.00	2.19	-214.99
18	6.50	-11.11	-212.79
19	7.00	-25.22	-203.74
20	7.50	-40.14	-187.44
21	8.00	-55.86	-163.47
22	8.50	-72.40	-131.44
23	9.00	-89.73	-90.94
24	9.14	-94.73	-78.03
25	9.15	-95.09	-77.08
26	9.16	-95.45	-76.13
27	9.50	-106.00	-41.80
28	10.00	-116.08	13.99
29	10.50	-119.71	73.21
30	11.00	-116.88	132.62
31	11.50	-107.59	189.01
32	12.00	-91.83	239.13
33	12.50	-69.62	279.76
34	13.00	-40.95	307.67
35	13.50	-5.82	319.63
36	13.58	0.40	319.85
37	14.00	35.78	312.41
38	14.50	83.83	282.78
39	15.00	138.34	227.50
40	15.50	199.32	143.35
41	16.00	266.75	27.11
42	16.09	279.57	2.52

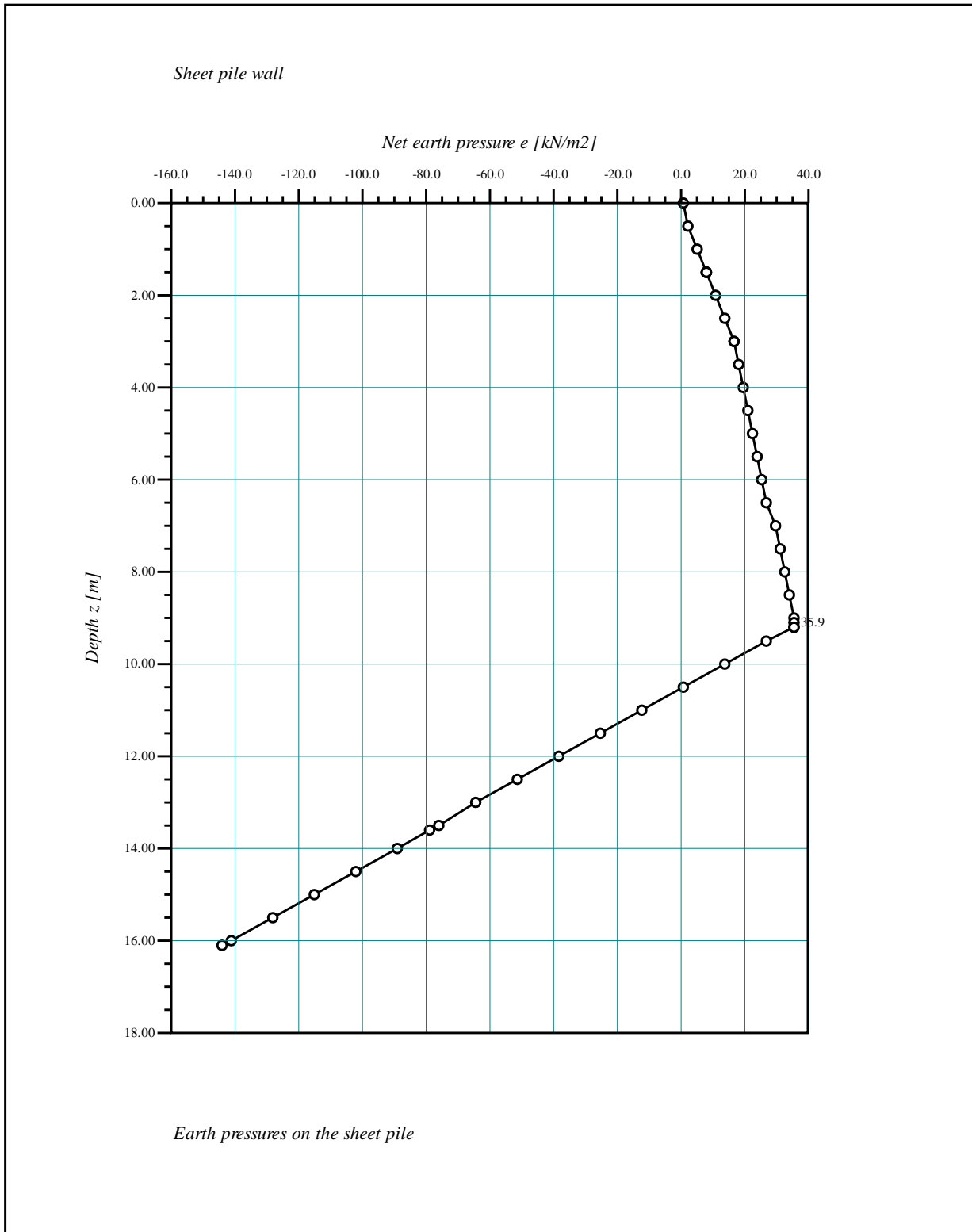

<p><b>GEOTEC Software Inc</b>                  PO Box 14001 Richmond Road PO, Calgary AB, Canada T3E 7Y7</p>	
<p><b>Scale: 1448</b>  <b>File: Ex11</b>  <b>Page No.:</b></p>	<p><b>Project: Example 9.9, page 477, Principles of Foundation Engineering, Das (2011)</b>  <b>Date: 07/11/2021</b>  <b>Title: Anchored sheet pile penetrating in sand by EBM</b></p>

Sheet pile wall

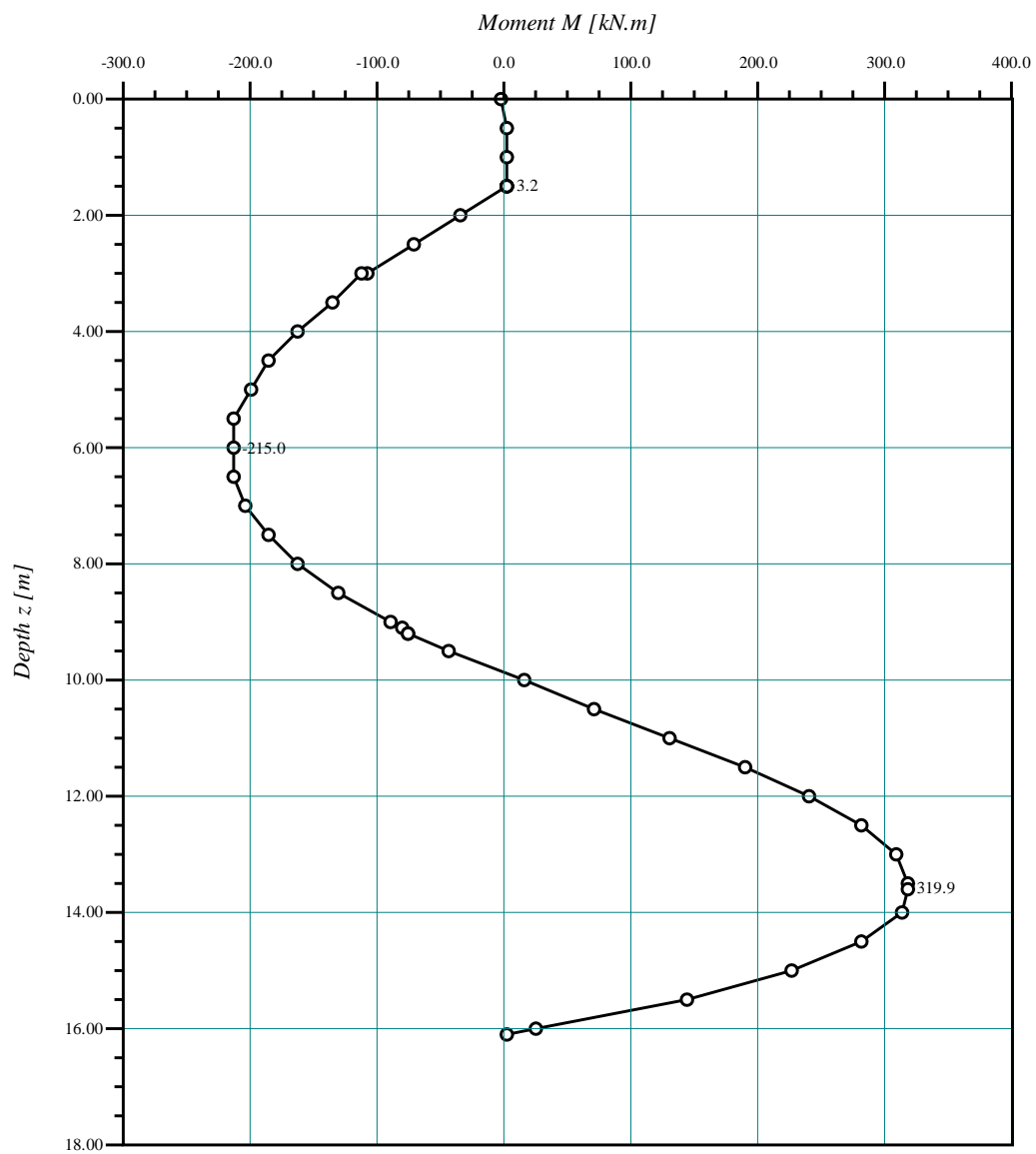

Moments

GEOTEC Software Inc

PO Box 14001 Richmond Road PO, Calgary AB, Canada T3E 7Y7

Scale: 4580

File: Ex11

Page No.:

Project: Example 9.9, page 477, Principles of Foundation Engineering, Das (2011)

Date: 07/11/2021

Title: Anchored sheet pile penetrating in sand by EBM

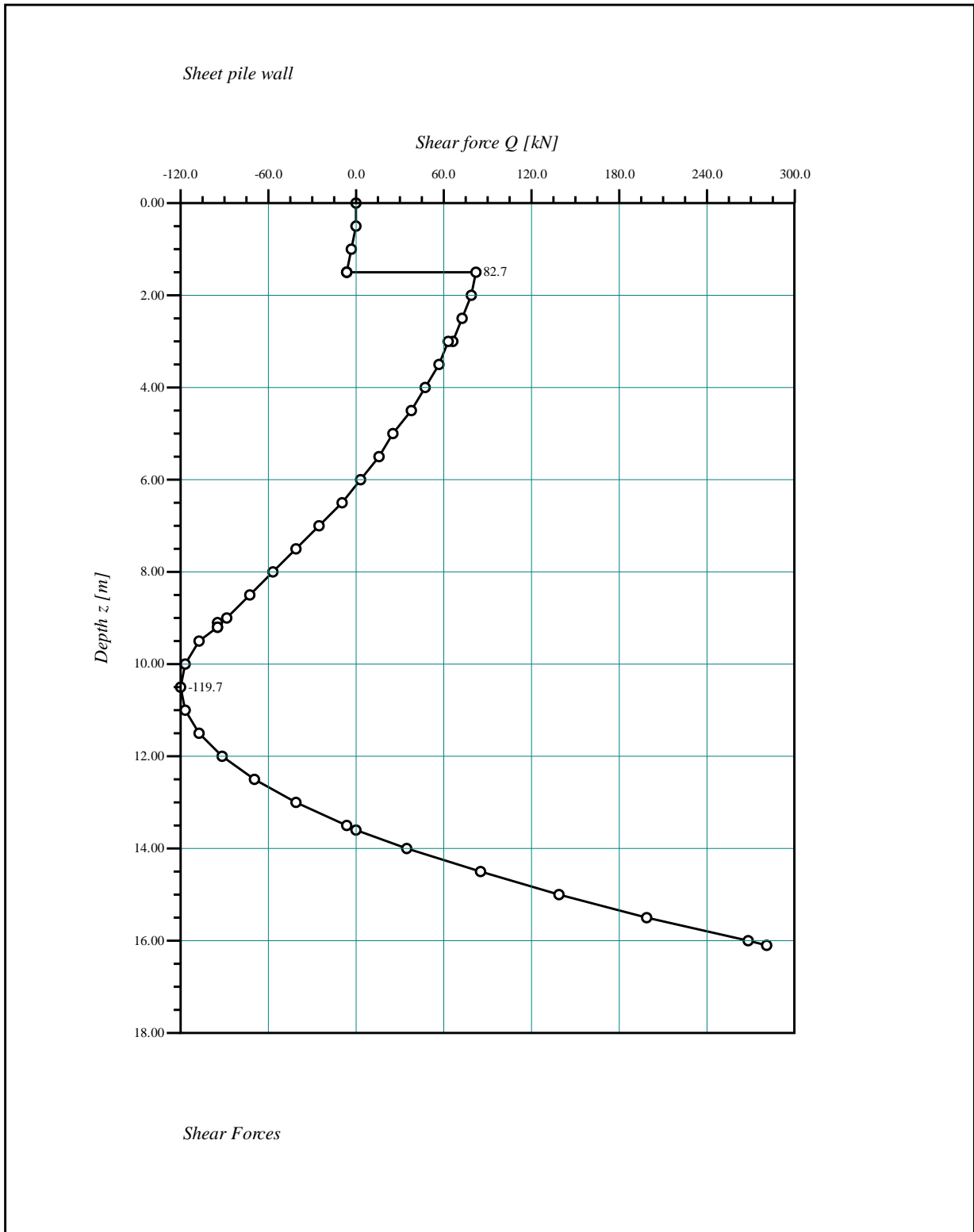

<p><b>GEOTEC Software Inc</b>                  PO Box 14001 Richmond Road PO, Calgary AB, Canada T3E 7Y7</p>	
<p><b>Scale:</b> 3156  <b>File:</b> Ex11  <b>Page No.:</b></p>	<p><b>Project:</b> Example 9.9, page 477, Principles of Foundation Engineering, Das (2011)  <b>Date:</b> 07/11/2021  <b>Title:</b> Anchored sheet pile penetrating in sand by EBM</p>

5.5.13 Example 12: Anchored sheet pile in sand by *Blum's* method

5.5.13.1 Description of the problem

To verify the analysis of an anchored sheet pile in the sand by *Blum's* method, the results of the anchored sheet pile in Figure 5.60, obtained by *Kort* (2002) using *Blum's* method, are compared with that obtained by *GEO Tools*. The sheet pile retains a 5-meter-deep excavation in dry sand with a unit weight of  $\gamma_d = 18 \text{ [kN/m}^3\text{]}$  and angle of friction  $\phi = 30 \text{ [}^\circ\text{]}$ .

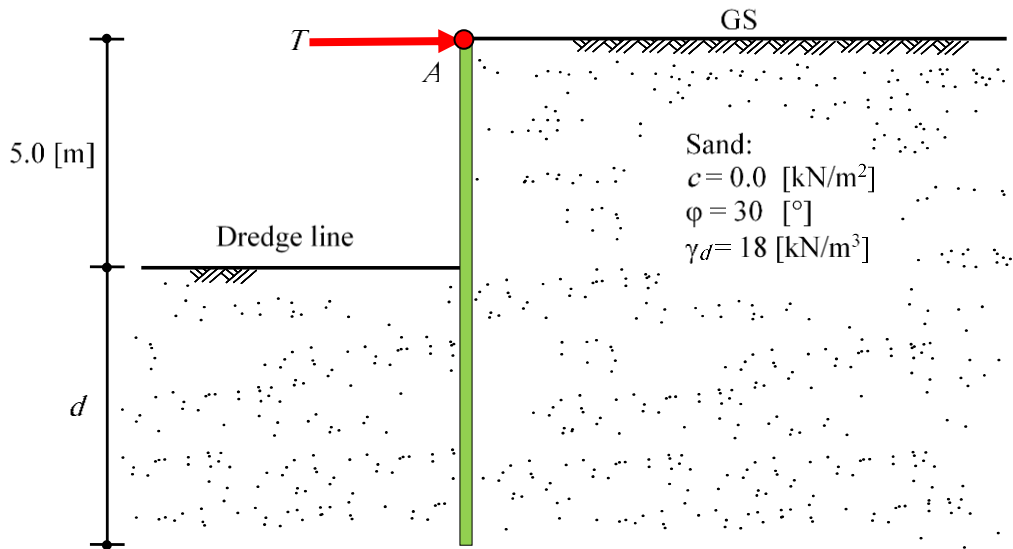

Figure 5.60 Anchored sheet pile in sand

Figure 5.61 shows earth pressure diagrams.

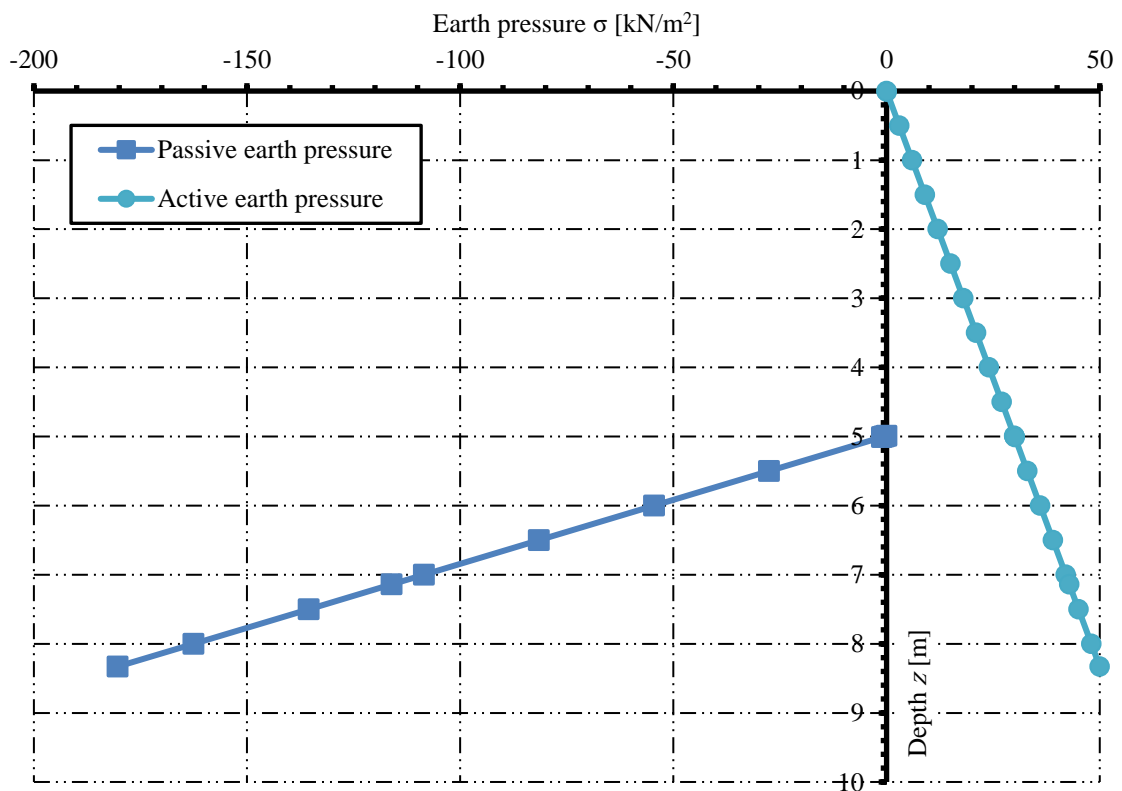

Figure 5.61 Earth pressures diagrams

### 5.5.13.2 Results by GEO Tools

Results obtained by *GEO Tools* for the anchored sheet pile in the sand by *Blum's* method show a good agreement with those of *Kort (2002)*, as shown in Table 5.43. The input data and results of *GEO Tools* for this example are presented on the next pages.

Table 5.43 Comparison of the results obtained by *GEO Tools* with those of *Kort (2002)*

	Penetration depth $d$ [m]	Moment arm from the surface $Y$ [m]	Max. Moment $M_{pl}$ [kN.m]	Anchor force $T$
<i>Kort (2002)</i>	3.37	3.15	61.85	29.56
<i>GEO Tools</i>	3.24	3.19	64.52	30.40

```

*****
                        GEO Tools
                        Version 12.2
Program authors Prof. M. El Gendy/ Dr. A. El Gendy
*****
Title: Anchored sheet pile in sand by Blum's method
Date: 07/11/2021
Project: Kort, D., A. (2002): Steel Sheet Pile Walls in Soft Soil
File: Ex12 Anchored SP in sand by Blum

-----
Anchored sheet pile wall with fixed earth support (Blum's method)
-----

Data:
Distributed load                q      [kN/m2] = 0.00
Safety factor for passive resistance  Fs1   [-]    = 1.00
Safety factor for penetration depth  Fs2   [-]    = 1.00
Depth of dredge line            L1    [m]    = 5.00
Anchor depth                     D     [m]    = 0.00

Soil Data:
Ground water depth-left         Gwl_L [m]    = 20.00
Ground water depth-right        Gwl_R [m]    = 20.00

Layer No.: 1
Cohesion of the soil           C     [kN/m2] = 0.000
Angle of internal friction      φ     [°]    = 30.00
Dry unit weight of the soil-left γd_L  [kN/m3] = 18.00
Saturated unit weight of the soil-left γsat_L [kN/m3] = 18.00
Dry unit weight of the soil-right γd_R  [kN/m3] = 18.00
Saturated unit weight of the soil-right γsat_R [kN/m3] = 18.00
Layer thickness                 h     [m]    = 20.00

Result:
Sheet pile length               L     [m]    = 8.24
Minimum sheet pile length       Lm    [m]    = 8.24
Minimum penetration depth       L2    [m]    = 3.24
Resistance force at the toe     R     [kN]   = 111.9
Anchor force                    T     [kN]   = 30.4
Maximum moment                  Mmax  [kN.m] = -64.52
Moment arm from the ground surface Y     [m]    = 3.19

```



## Sheet Pile Wall

Earth pressures on the sheet pile:

No.	Depth	Passive earth pressure from soil weight	Active earth pressure from soil weight	Earth pressure
I	z	ep	ea	E
[-]	[m]	[kN/m <sup>2</sup> ]	[kN/m <sup>2</sup> ]	[kN/m <sup>2</sup> ]
1	0.00	0.00	0.00	0.00
2	0.01	0.00	0.06	0.06
3	0.50	0.00	3.00	3.00
4	1.00	0.00	6.00	6.00
5	1.50	0.00	9.00	9.00
6	2.00	0.00	12.00	12.00
7	2.50	0.00	15.00	15.00
8	3.00	0.00	18.00	18.00
9	3.19	0.00	19.14	19.14
10	3.50	0.00	21.00	21.00
11	4.00	0.00	24.00	24.00
12	4.50	0.00	27.00	27.00
13	4.99	0.00	29.94	29.94
14	5.00	-0.54	30.00	29.46
15	5.01	-1.08	30.06	28.98
16	5.50	-27.54	33.00	5.46
17	6.00	-54.54	36.00	-18.54
18	6.50	-81.54	39.00	-42.54
19	7.00	-108.54	42.00	-66.54
20	7.50	-135.54	45.00	-90.54
21	8.00	-162.54	48.00	-114.54
22	8.24	-175.50	49.44	-126.06

Shear Forces/ Moments:

No.	Depth	Shear force	Moment
I	z	Q	M
	[m]	[kN]	[kN.m]
1	0.00	30.40	0.00
2	0.01	30.40	-0.30
3	0.50	29.65	-15.08
4	1.00	27.40	-29.40
5	1.50	23.65	-42.23
6	2.00	18.40	-52.81
7	2.50	11.65	-60.38
8	3.00	3.40	-64.21
9	3.19	-0.13	-64.52
10	3.50	-6.35	-63.54
11	4.00	-17.60	-57.61
12	4.50	-30.35	-45.69
13	4.99	-44.30	-27.46
14	5.00	-44.59	-27.02
15	5.01	-44.89	-26.57
16	5.50	-53.32	-2.04
17	6.00	-50.05	24.31
18	6.50	-34.78	46.02
19	7.00	-7.51	57.09
20	7.50	31.76	51.53
21	8.00	83.03	23.34
22	8.24	111.90	0.00

Sheet pile wall

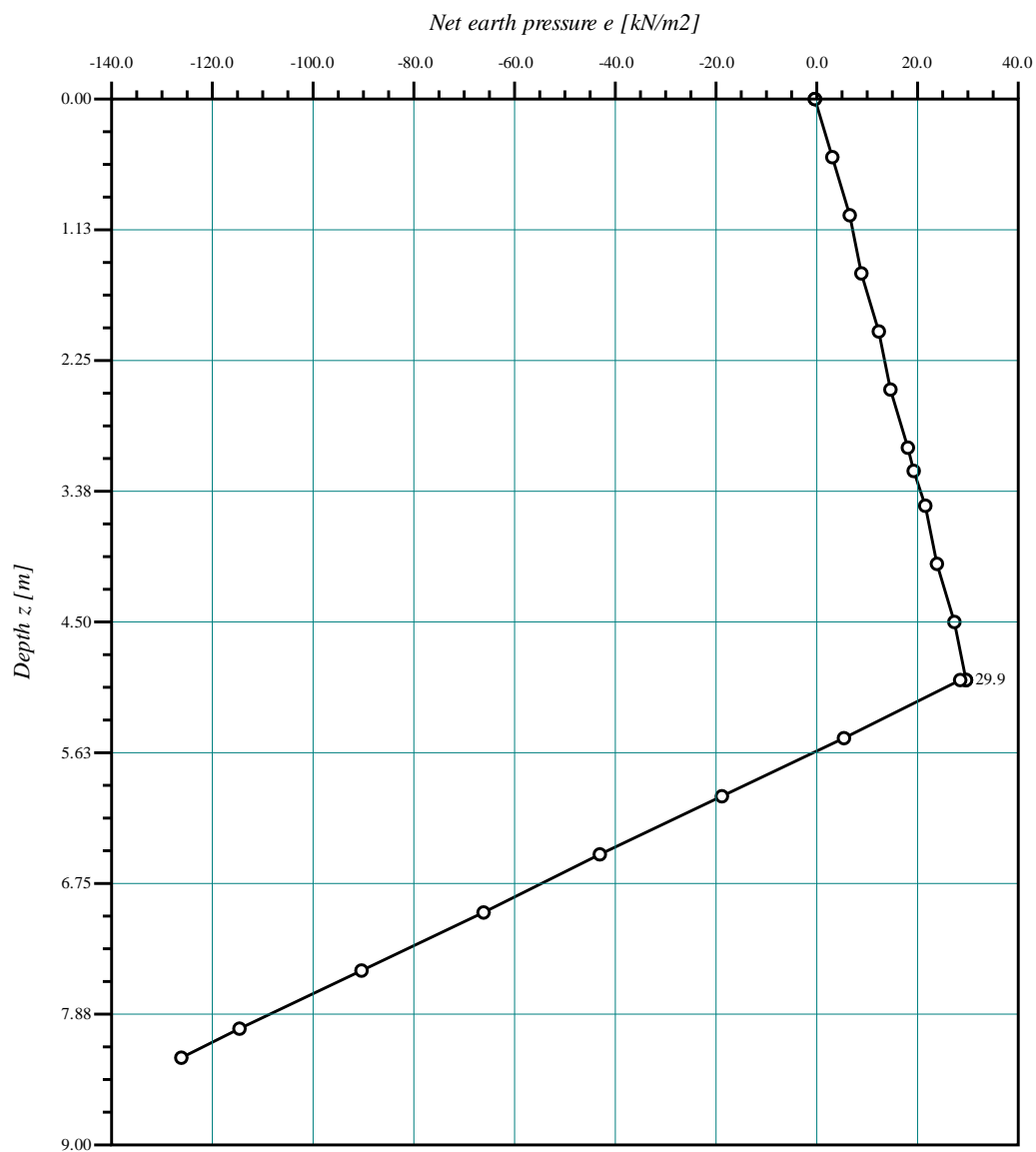

Earth pressures on the sheet pile

GEOTEC Software Inc

PO Box 14001 Richmond Road PO, Calgary AB, Canada T3E 7Y7

Scale: 1154

File: Ex12

Page No.:

Project: Kort, D., A. (2002): Steel Sheet Pile Walls in Soft Soil

Date: 07/11/2021

Title: Anchored sheet pile in sand by Blum's Method

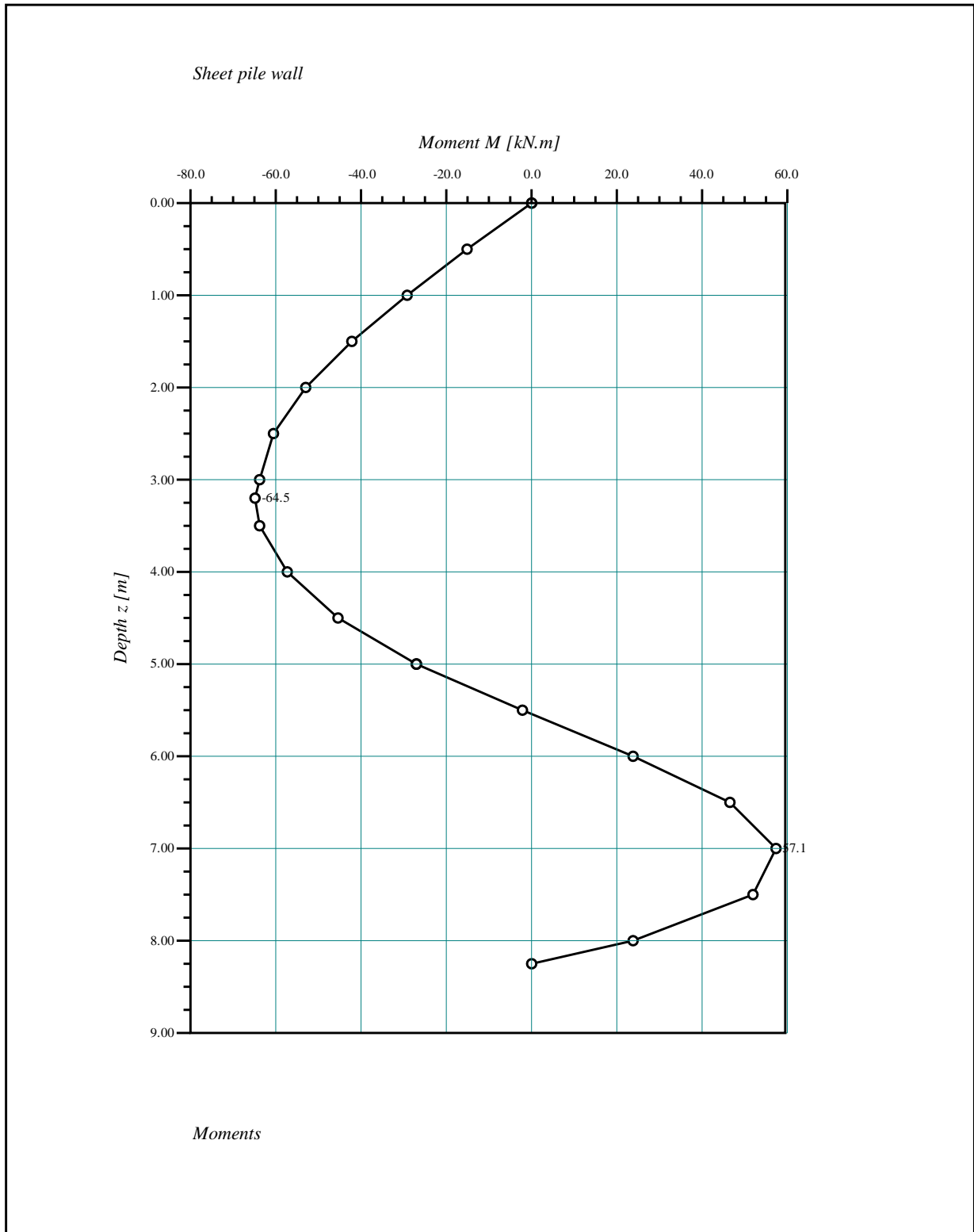

*Moments*

<p><b>GEOTEC Software Inc</b>                  PO Box 14001 Richmond Road PO, Calgary AB, Canada T3E 7Y7</p>	
<p><b>Scale: 1081</b>  <b>File: Ex12</b>  <b>Page No.:</b></p>	<p><b>Project: Kort, D., A. (2002): Steel Sheet Pile Walls in Soft Soil</b>  <b>Date: 07/11/2021</b>  <b>Title: Anchored sheet pile in sand by Blum's Method</b></p>

Sheet pile wall

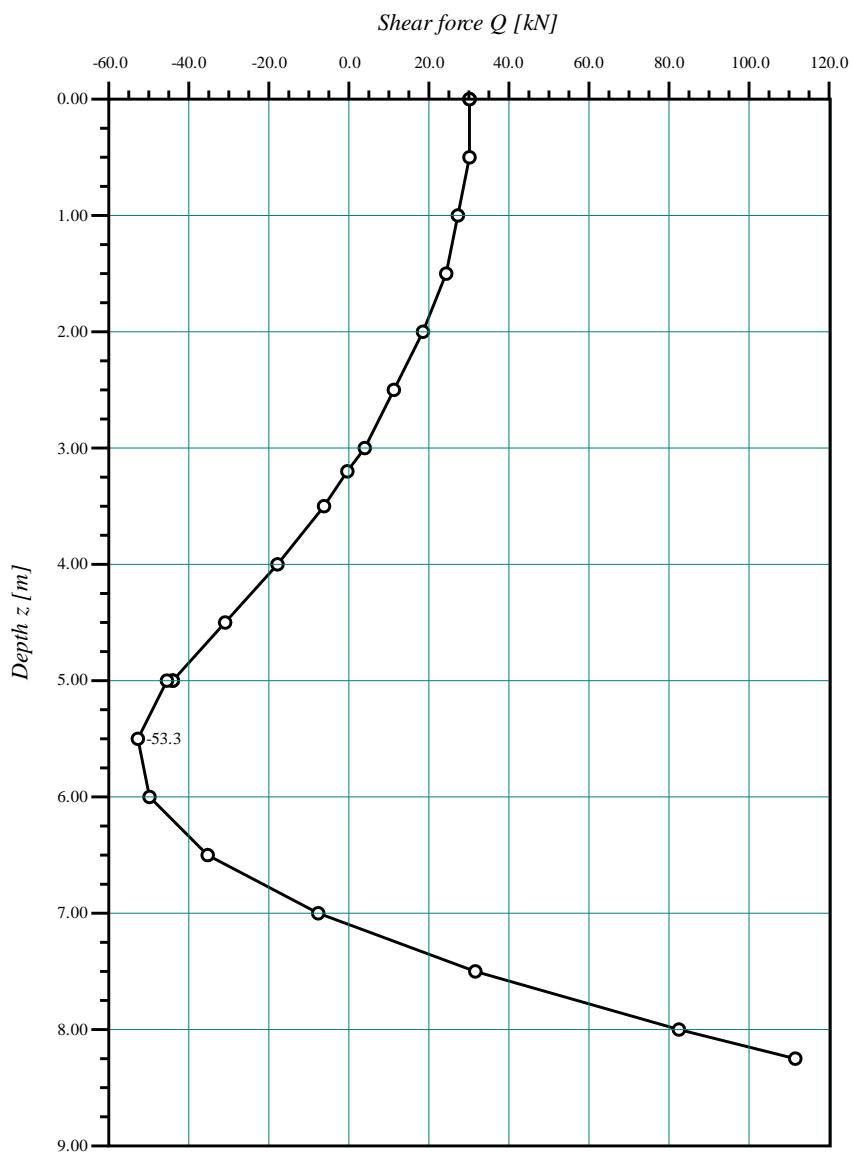

Shear Forces

GEOTEC Software Inc

PO Box 14001 Richmond Road PO, Calgary AB, Canada T3E 7Y7

Scale: 1454

File: Ex12

Page No.:

Project: Kort, D., A. (2002): Steel Sheet Pile Walls in Soft Soil

Date: 07/11/2021

Title: Anchored sheet pile in sand by Blum's Method

## 5.6 References

- [1] *Al-Agha, A. S. (2015): Solved Problems in Soil Mechanics. Eighteenth Edition.*
- [2] *Blum, H. (1931): Einspannungsverhältnisse bei Bohlwerken.*  
W. Ernst und Sohn, Berlin, Germany
- [3] *Craig, R. F. (2012): Craig's Soil Mechanics.*  
Spon Press, New York.
- [4] *Das, B. M. (2011): Principles of Foundation Engineering.*  
Seventh Edition. Learning, USA.
- [5] ECP 464 (1989): The Egyptian Code of Practice, Design and Construction of Reinforced Concrete Structures (in Arabic)
- [6] *Kort, D., A. (2002): Steel Sheet Pile Walls in Soft Soil.*  
DUP Science, Delft University Press