

Analysis and Design of Foundation Tarut Bridge Qatif city- Saudi Arabia



Location: The bridge links Nasriya ward with Qatif and Mishari Quarter with Tarut Island, 500 m long in sea 4.9 m above the sea surface.

Type of foundation: Water level foundation on large diameter piles

Cost: SR 100+ million

Ahmad Al Mousa Office for Engineering Consultations, Dammam, Saudi Arabia

October, 2010



This file contains some output samples of GEOTEC Office during the preliminary and doesn't contain the final complete set of the design.

The purpose of the document is to show GEOTEC office capabilities only.

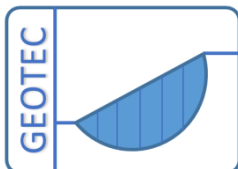

GEOTEC Software Inc.

PO Box 14001 Richmond Road PO, Calgary AB, Canada T3E 7Y7

Tele.:+1(587) 332-3323

geotec@geotecsoftware.com

www.geotecsoftware.com

Content	Page
1 Introduction.....	3
1.1 Description of the project.....	3
1.2 Methods of analysis and design	4
1.3 Choosing pile diameter and design load	5
1.4 Spacing between piles.....	6
1.5 Design of reinforced concrete section.....	6
2 Offshore - Single pile analysis.....	7
3 Offshore - Pile cap analysis	25
4 Offshore - Pile cap design.....	40
5 Offshore - Check for uplift.....	74
6 Offshore - Seismic analysis.....	74
7 Onshore - Single pile analysis	74
8 Pile foundation analysis - left side	92
9 Pile foundation design - left side.....	110
10 Pile foundation analysis - right side	150
11 Pile foundation design - right side.....	168
12 Tunnel floor analysis – Left side.....	207
13 Tunnel floor design – Left side	221
14 Check for uplift - Left tunnel.....	246
15 Tunnel floor analysis – Right side	246
16 Tunnel floor design – Right side.....	262
17 Check for uplift - Righth tunnel	- 291 -
18 References.....	- 291 -

1 Introduction

1.1 Description of the project

Tarut Bridge is a bridge on the road connecting between *Tarut* island and *Qatif* city, *Saudi Arabia*. The bridge is 30.5 [m] wide over 9 spans in the Gulf, each is 25 [m]. Figure 1 shows the location of the bridge, while Figure 2 shows the project site.

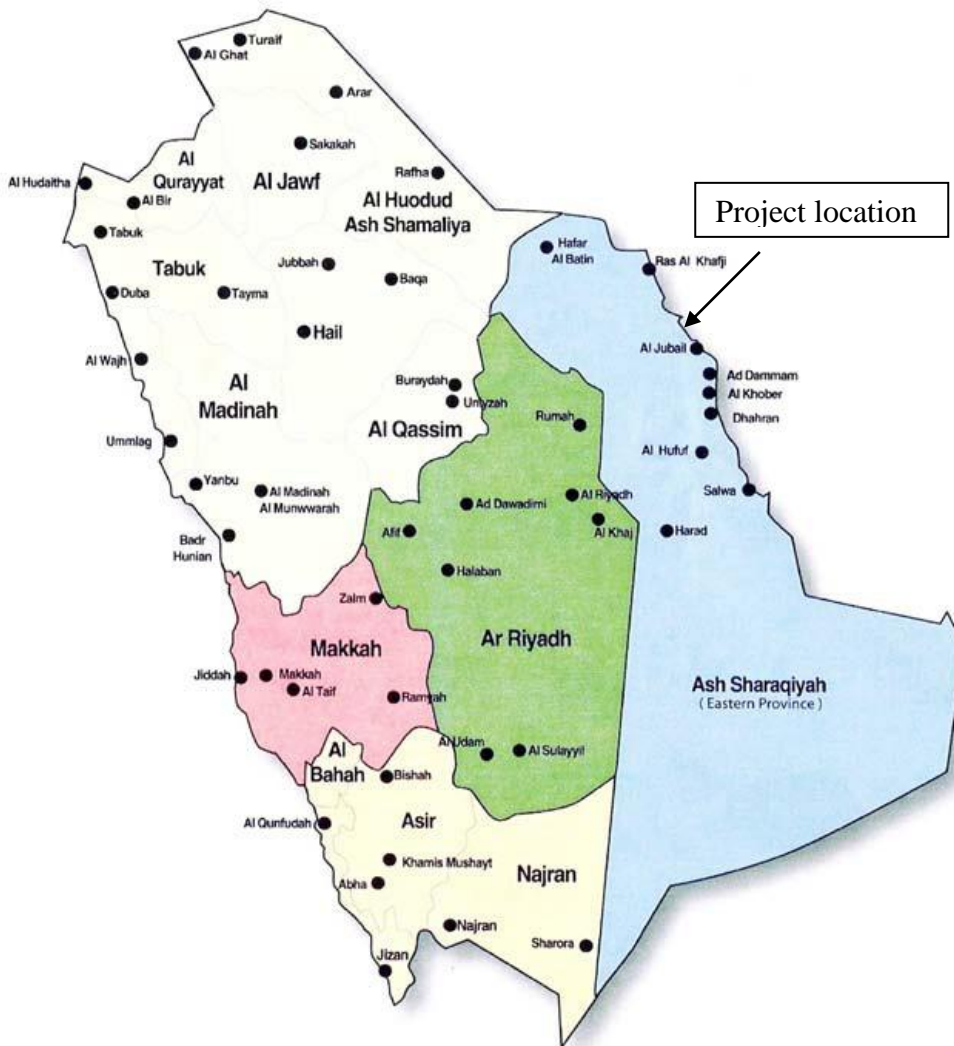

Figure 1 Project location

This report presents part of the analysis and design of the foundation bridge as a sample of GEOTEC Office output.

Offshore Area: Foundation is selected to be "Waterline Footing" type. It is consist of a pile cap of 1.25 [m] thickness and 26 [m] × 6 [m] area. The pile cap is a support to three columns with about 6000 [kN] vertical load for each. A total of 16 bored piles with diameter of $D = 1.4$ [m], are arranged under the pile cap. The total pile length is 37.5 [m], which is consists of (28 [m] + 3 D) under the sea bed level and 5 [m] above the sea bed level. The subsoil at the location of the bridge consists of variable layers of sand and clay with different properties up to a depth of 25 [m] under the sea bed level as indicated in the geotechnical report prepared by *Gulf Consult, Al Khobar, Saudi Arabia*.

Onshore Area: Foundation is selected to be a floor slab on piles. The left side foundation consists of a floor slab of 0.5 [m] thickness and 51.1 [m] \times 30.5 [m] area over 64 bored piles with diameter of $D = 1.2$ [m]. The floor slab is a support to a uniform load of 13 [kN/m²], besides a line load from the bridge support equal to 384 [kN/m]. Piles are arranged under the floor slab in strips with pile caps.

The right side foundation consists of a floor slab of 0.5 [m] thickness and 51.1 [m] length \times 44.42 [m] width over 64 bored piles with diameter of $D = 1.2$ [m]. The floor slab is a support to a uniform load of 13 [kN/m²], besides a line load from the bridge support equal to 346 [kN/m]. Piles are arranged under the floor slab in strips with pile caps.

The total pile length is 36 [m], which is consists of (28 [m] + 3 D) under the sea bed level and 5 [m] above the sea bed level. The subsoil at the location of the bridge consists of variable layers of sand and clay with different properties up to a depth of 35 [m] under the sea bed level as indicated in the geotechnical report prepared by *Gulf Consult, Al Khobar, Saudi Arabia*.



Figure 2 Project site

1.2 Methods of analysis and design

The analysis of single piles and pile caps for offshore was carried out by the program *ELPLA* (2008). A series of analyses were carried out to choose the suitable pile diameter by evaluating the load-settlement behavior of single piles. The load-settlement relation is determined according to *ECP 197* (1995) for bored piles of diameters greater than 60 [cm]. Pile cap was analyzed by the method of *NPRD* developed by *M. El Gendy et al.* (2006). Internal forces in the pile cap was determined by the finite-element method.

The pile cap is considered to be rigidly supported on equal rigid piles with an effective length equal to 28 [m]. Soil layers of total depth $H = 50$ [m] with a different soil properties were considered.

For *NPRD*, the load-settlement relation for piles was determined using the skin friction determined according *ECP 197* (1995), while the pile-pile interaction was determined from the theory of elasticity using an appropriate *Young's* modulus and *Poisson's* ratio for the soil layers. The *Young's* modulus was estimated from the following parabolic correlation between N of *SPT* and drained *Young's* modulus E proposed by *Denver* (1982):

$$E = 7 N^{0.5} \text{ [Mpa]} \quad (1)$$

The uplift pressure on the pile cape due to water level was neglected in the analysis to get maximum compressive applied load on the cap. Then, a check for uplift is carried out later to insure that the pile cap can resist the uplift force. The total applied load on the pile cap including own weight of the pile cap and piles is $R = 42219$ [kN].

1.3 Choosing pile diameter and design load

The summary of the single pile analysis is listed in Tables 1 and 2. The design load for the single pile for all diameters is chosen to meet a settlement of 1.0 [cm]. Consideration is given also to using a wider pile in diameter to develop bearing loads in less number of piles. Accordingly, a pile of diameter 1.0 to 1.4 [m] and length of 28 [m] is chosen. The design load for the chosen pile is about 2500 [kN]. Due to the group action, the settlement of the chosen pile in the pile group is expected to be higher than that obtained from the single pile analysis.

Table 1: Pile load and settlement for BH 1

Pile diameter d [m]	Pile length L_p [m]	Allowable pile load Q_{all} [kN]	Allowable pile settlement S_{all} [cm]	Design pile load Q_v [kN]	Expected settlement S_e [cm]
1.0	28	3593.2	1.58	2250	0.99
1.2		4424.9	1.62	2700	0.99
1.4		5294.4	1.66	3200	1.00

Table 2: Pile load and settlement for BH 4

Pile diameter d [m]	Pile length L_p [m]	Allowable pile load Q_{all} [kN]	Allowable pile settlement S_{all} [cm]	Design pile load Q_v [kN]	Expected settlement S_e [cm]
1.0	28	4033.8	1.71	2350	0.99
1.2		5070.7	1.79	2800	0.99
1.4		6184.4	1.87	3300	1.00

Table 1: Pile load and settlement for BH 3

Pile diameter d [m]	Pile length L _p [m]	Allowable pile load Q _{all} [kN]	Allowable pile settlement S _{all} [cm]	Design pile load Q _v [kN]	Expected settlement S _e [cm]
1.0	28	3083	1.59	2000	1.03
1.2		3812	1.64	2100	0.90
1.4		4580	1.69	2500	0.92

Table 2: Pile load and settlement for BH 5

Pile diameter d [m]	Pile length L _p [m]	Allowable pile load Q _{all} [kN]	Allowable pile settlement S _{all} [cm]	Design pile load Q _v [kN]	Expected settlement S _e [cm]
1.0	28	3181	1.59	2000	1.03
1.2		3930	1.64	2250	0.94
1.4		4747	1.68	2500	0.89

1.4 Spacing between piles

According to Bowels (1977), the National Building Codes states that the minimum distance between centers of piles not driven to rock shall not be less than $2D$ for round piles. Large spacing is impractical, since a pile cap is cast over a group of piles. In this case, large spacing will require massive and heavy pile caps carried by the piles. The spacing of piles is taken to be 2.14 to $2.5D$ (3.00 to 3.50 [m]).

1.5 Design of reinforced concrete section

Design of reinforcement concrete section was carried out according to *ECP 203* (2007) by "working stress design method".

Design data

Characteristic strength of concrete	F_{cu}	= 30	[N/mm ²]
Characteristic strength of steel (High Tensile Steel grade 36/52)	F_y	= 360	[N/mm ²]
Allowable punching shear stress	q_{cp}	= 1	[N/mm ²]
Thickness of pile caps	t	= 1.25	[m]
Young's modulus of pile cap material	E_p	= 2.4×10^7	[kN/m ²]
Poisson's ratio of the slab	ν_p	= 0.2	[-]
Concrete cover for pile cap	c	= 7	[cm]

Minimum steel reinforcement in pile cap section:

$$\begin{aligned} \text{Min. Cap } A_s &= 0.15 \% (\text{Cap } A_c) \\ &= (0.15/100) \times 125 \times 100 = 18.75 \text{ [cm}^2\text{/m]} \\ \text{Min. Cap } A_s &= 6\Phi 25/\text{m} \quad (29.45 \text{ [cm}^2\text{/m]}) \end{aligned}$$

Minimum steel reinforcement in pile section:

$$\begin{aligned} \text{Min. Pile } A_s &= 1.0 \% (\text{Pile } A_c) \\ &= (1.0/100) \times \pi \times 140^2 / 4 = 154 \text{ [cm}^2\text{/m]} \\ \text{Min. Pile } A_s &= 32\Phi 25/\text{m} \quad (157.12 \text{ cm}^2\text{/m}) \end{aligned}$$

2 Offshore - Single pile analysis

 GeoTools
 Version 2010
 Program authors Prof. M. El Gendy/ Dr. A. El Gendy

Title: Bearing capacity of a single pile BH-5, D=1.0 [m]
Date: 25/09/2010
Project: Tarut bridge, Qatif city- Saudi Arabia
File: BH-5 - D 1.0 m

 Bearing capacity and settlement of a single pile
 according to ECP (1995)

Data:
 Pile diameter D [m] = 1.00
 Pile toe diameter Df [m] = 1.00
 Pile length Lg [m] = 28.00

Soil property

Layer	Layer Depth Under the SBL [m]	Soil Type	Av. SPT N Value	Bulk Unit Wt. [kN/m3]	Angle of Int. friction Φ [deg]	Undrainage cohesion Cu [kN/m2]	Modulus of Elasticity E [kN/m2]
1	0-3	CL-ML	1	15	-	50	7000
2	3-7.5	SM	30	18	35	-	38000
3	7.5-12	GM	>100	19.5	38	-	70000
4	12-15	SM	28	18	35	-	37000
5	15-18	CL	38	19	-	150	43000
6	18-22.5	SC-SM	48	19.5	31	-	48000
7	22.5-25	CL	>100	19.5	-	250	70000

Estimation of pile skin friction for non-cohesive soil

Layer	Soil Type	Layer Depth Under the SBL [m]	Angle of Int. friction Φ [deg]	Av. SPT N Value	Values according ECP (1995)		
					depth	SPT	Skin friction τ [kN/m2]
2	SM	3-7.5	35	30	2-7.5	20-30	45
3	GM	7.5-12	38	>100	2-10	>30	60
4	SM	12-15	35	28	>7.5	20-30	75
6	SC-SM	18-22.5	31	48	>10	>30	100

Estimation of pile skin friction for cohesive soil

Layer	Soil Type	Layer Depth Under the SBL [m]	Undrainage cohesion Cu [kN/m2]	Av. SPT N Value	Values according ECP (1995)	
					Undrainage cohesion Cu [kN/m2]	Skin friction τ [kN/m2]
1	CL-ML	0-3	50	1	50	35
5	CL	15-18	150	38	150	45
7	CL	22.5-25	250	>100	250	50

Tarut Bridge - Analysis and design of foundation

Summary of results

File tip resistance (Given)

s/Df = 0.02 Sig [kN/m2] = 500
s/Df = 0.03 Sig1 [kN/m2] = 700
s/Df = 0.10 SigGR [kN/m2] = 1200

Internal results

Skin friction:

Layer No.	Layer thickness	Penetration tip resistance	Undrainage cohesion of soil	Skin friction	Friction force
I	L1	qs	Cu	Tau	Qrg
[-]	[m]	[kN/m2]	[kN/m2]	[kN/m2]	[kN]
1	3.00	-----	-----	35.000	329.9
2	4.50	-----	-----	45.000	636.2
3	4.50	-----	-----	60.000	848.2
4	3.00	-----	-----	75.000	706.9
5	3.00	-----	-----	45.000	424.1
6	4.50	-----	-----	100.000	1413.7
7	5.50	-----	-----	50.000	863.9

Sum of friction forces Qrf [kN] = 5222.9

Load on pile head **Qma+Qsp = Qv [kN] = 2000.0**
Skin friction part from Qv Qma [kN] = 1809.5
End bearing part from Qv Qsp [kN] = 190.5
Expected settlement **sv [cm] = 1.03**

File resistance depending on pile settlement:

No.	Referred settlement	File tip settlement	File friction resistance	Tip resistance	File resistance
I	s/Df	s	Qr	Qs	Q
[-]	[-]	[cm]	[kN]	[kN]	[kN]
1	0.02	2.00	3481.9	392.7	3874.6
2	0.03	3.00	5222.9	549.8	5772.7
3	0.03	3.00	5222.9	549.8	5772.7
4	0.10	10.00	5222.9	942.5	6165.4 = Qg=2*Qzul

Final results:

Allowable settlement **Szul [cm] = 1.59**
Allowable pile load **Qr+Qs = Qzul [kN] = 3082.7**
Skin friction part Qr [kN] = 2770.3
End bearing part Qs [kN] = 312.4
Safety factor Qzul/QV = ETHA [-] = 1.54

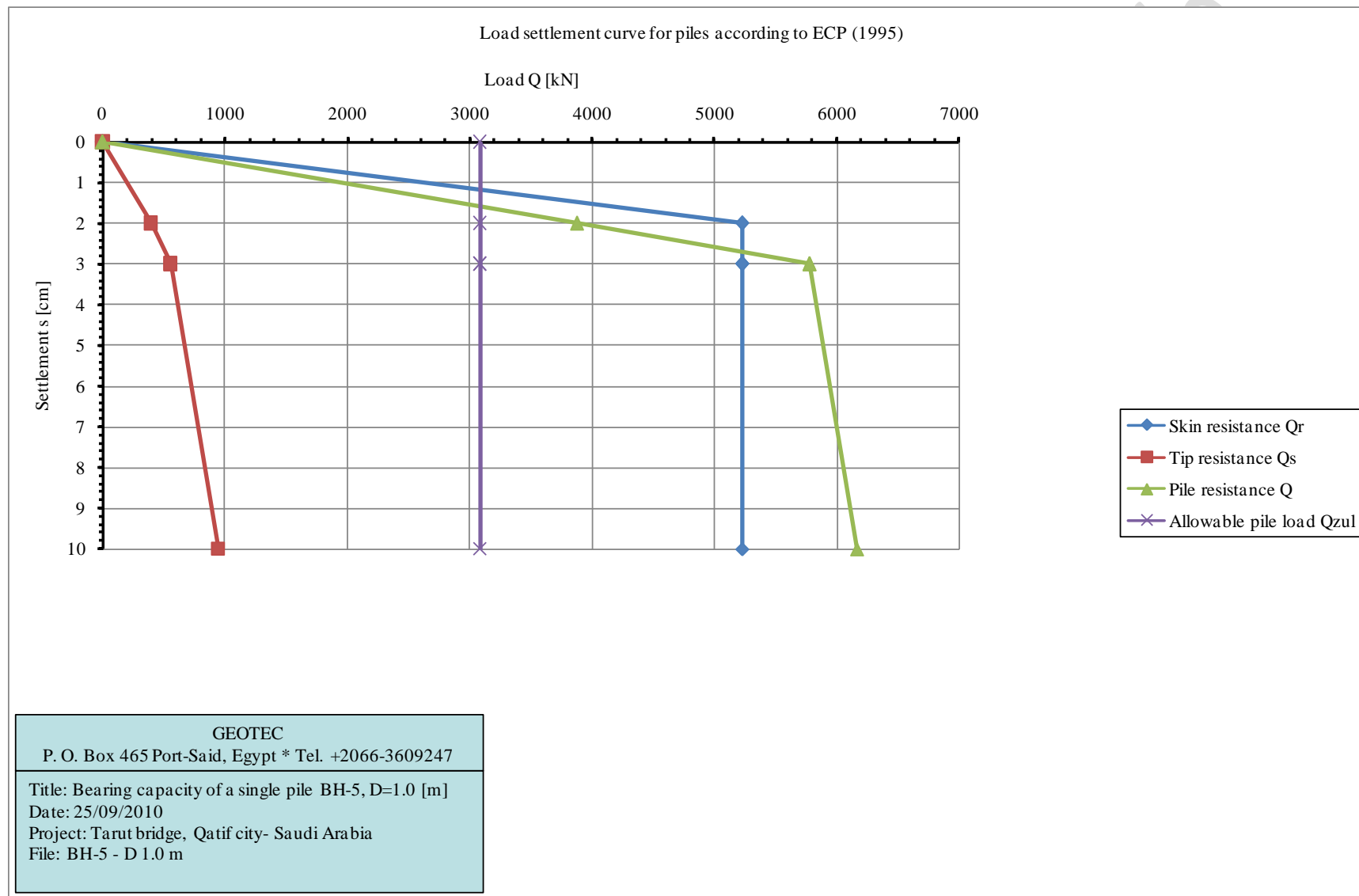

Tarut Bridge - Analysis and design of foundation

GeoTools
Version 2010

Program authors Prof. M. El Gendy/ Dr. A. El Gendy

Title: Bearing capacity of a single pile BH-5, D=1.2 [m]

Date: 25/09/2010

Project: Tarut bridge, Qatif city- Saudi Arabia

File: BH-5 - D 1.2 m

Bearing capacity and settlement of a single pile
according to ECP (1995)

Data:

File diameter D [m] = 1.20
File toe diameter Df [m] = 1.20
File length Lg [m] = 28.00

Soil property

Layer	Layer Depth Under the SBL [m]	Soil Type	Av. SPT N Value	Bulk Unit Wt. [kN/m3]	Angle of Int. friction Φ [deg]	Undrainage cohesion Cu [kN/m2]	Modulus of Elasticity E [kN/m2]
1	0-3	CL-ML	1	15	-	50	7000
2	3-7.5	SM	30	18	35	-	38000
3	7.5-12	GM	>100	19.5	38	-	70000
4	12-15	SM	28	18	35	-	37000
5	15-18	CL	38	19	-	150	43000
6	18-22.5	SC-SM	48	19.5	31	-	48000
7	22.5-25	CL	>100	19.5	-	250	70000

Estimation of pile skin friction for non-cohesive soil

Layer	Soil Type	Layer Depth Under the SBL [m]	Angle of Int. friction Φ [deg]	Av. SPT N Value	Values according ECP (1995)		
					depth	SPT	Skin friction τ [kN/m2]
2	SM	3-7.5	35	30	2-7.5	20-30	45
3	GM	7.5-12	38	>100	2-10	>30	60
4	SM	12-15	35	28	>7.5	20-30	75
6	SC-SM	18-22.5	31	48	>10	>30	100

Estimation of pile skin friction for cohesive soil

Layer	Soil Type	Layer Depth Under the SBL [m]	Undrainage cohesion Cu [kN/m2]	Av. SPT N Value	Values according ECP (1995)	
					Undrainage cohesion Cu [kN/m2]	Skin friction τ [kN/m2]
1	CL-ML	0-3	50	1	50	35
5	CL	15-18	150	38	150	45
7	CL	22.5-25	250	>100	250	50

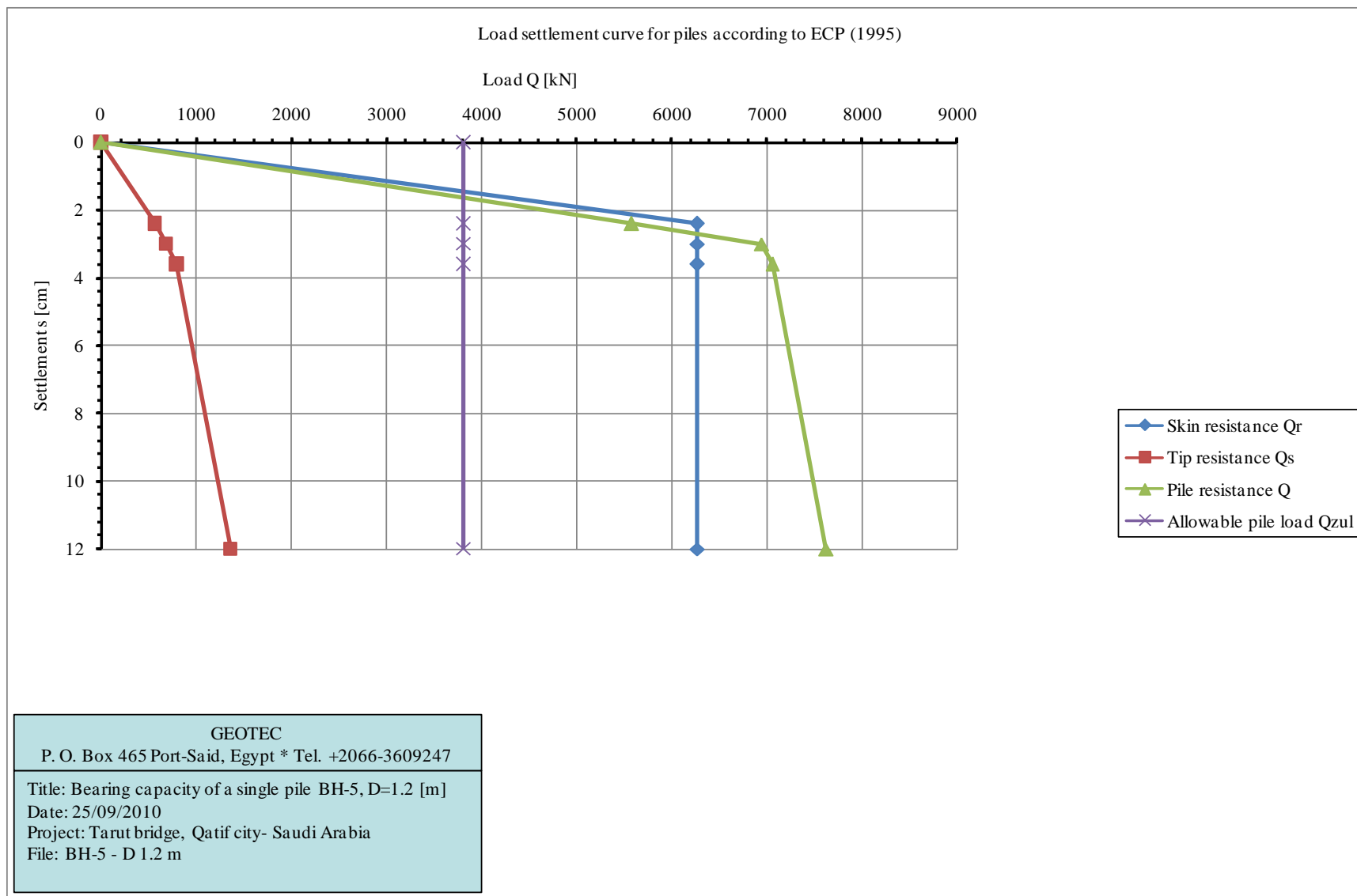

Tarut Bridge - Analysis and design of foundation

GeoTools
Version 2010

Program authors Prof. M. El Gendy/ Dr. A. El Gendy

Title: Bearing capacity of a single pile BH-5, D=1.4 [m]

Date: 25/09/2010

Project: Tarut bridge, Qatif city- Saudi Arabia

File: BH-5 - D 1.4 m

Bearing capacity and settlement of a single pile
according to ECP (1995)

Data:

File diameter		D	[m]	=	1.40
File toe diameter		Df	[m]	=	1.40
File length		Lg	[m]	=	28

Soil property

Layer	Layer Depth Under the SBL [m]	Soil Type	Av. SPT N Value	Bulk Unit Wt. [kN/m3]	Angle of Int. friction Φ [deg]	Undrainage cohesion Cu [kN/m2]	Modulus of Elasticity E [kN/m2]
1	0-3	CL-ML	1	15	-	50	7000
2	3-7.5	SM	30	18	35	-	38000
3	7.5-12	GM	>100	19.5	38	-	70000
4	12-15	SM	28	18	35	-	37000
5	15-18	CL	38	19	-	150	43000
6	18-22.5	SC-SM	48	19.5	31	-	48000
7	22.5-25	CL	>100	19.5	-	250	70000

Estimation of pile skin friction for non-cohesive soil

Layer	Soil Type	Layer Depth Under the SBL [m]	Angle of Int. friction Φ [deg]	Av. SPT N Value	Values according ECP (1995)		
					depth	SPT	Skin friction τ [kN/m2]
2	SM	3-7.5	35	30	2-7.5	20-30	45
3	GM	7.5-12	38	>100	2-10	>30	60
4	SM	12-15	35	28	>7.5	20-30	75
6	SC-SM	18-22.5	31	48	>10	>30	100

Estimation of pile skin friction for cohesive soil

Layer	Soil Type	Layer Depth Under the SBL [m]	Undrainage cohesion Cu [kN/m2]	Av. SPT N Value	Values according ECP (1995)	
					Undrainage cohesion Cu [kN/m2]	Skin friction τ [kN/m2]
1	CL-ML	0-3	50	1	50	35
5	CL	15-18	150	38	150	45
7	CL	22.5-25	250	>100	250	50

Tarut Bridge - Analysis and design of foundation

Summary of results

File tip resistance (Given)

s/Df = 0.02

s/Df = 0.03

s/Df = 0.10

Sig [kN/m²] = 500

Sig1 [kN/m²] = 700

SigGR [kN/m²] = 1200

Internal results

Skin friction:

Layer No.	Layer thickness [m]	Penetration tip resistance [kN/m ²]	Undrainage cohesion of soil Cu [kN/m ²]	Skin friction Tau [kN/m ²]	Friction force Qrg [kN]
1	3.00	-----	-----	35.000	461.8
2	4.50	-----	-----	45.000	890.6
3	4.50	-----	-----	60.000	1187.5
4	3.00	-----	-----	75.000	989.6
5	3.00	-----	-----	45.000	593.8
6	4.50	-----	-----	100.000	1979.2
7	5.50	-----	-----	50.000	1209.5

Sum of friction forces Qrf [kN] = 7312.1

Load on pile head Qma+Qsp = Qv [kN] = 2500.0
 Skin friction part from Qv Qma [kN] = 2249.7
 End bearing part from Qv Qsp [kN] = 250.3
Expected settlement sv [cm] = 0.92

File resistance depending on pile settlement:

No.	Referred settlement s/Df [-]	Pile tip settlement s [cm]	Pile friction resistance Qr [kN]	Tip resistance Qs [kN]	Pile resistance Q [kN]
1	0.02	2.80	6824.6	769.7	7594.3
2	0.02	3.00	7312.1	813.7	8125.7
3	0.03	4.20	7312.1	1077.6	8389.6
4	0.10	14.00	7312.1	1847.3	9159.3 = Qg=2*Qzul

Final results:

Allowable settlement Szul [cm] = 1.69
Allowable pile load Qr+Qs = Qzul [kN] = 4579.7
 Skin friction part Qr [kN] = 4115.5
 End bearing part Qs [kN] = 464.2
 Safety factor Qzul/QV = ETHA [-] = 1.83

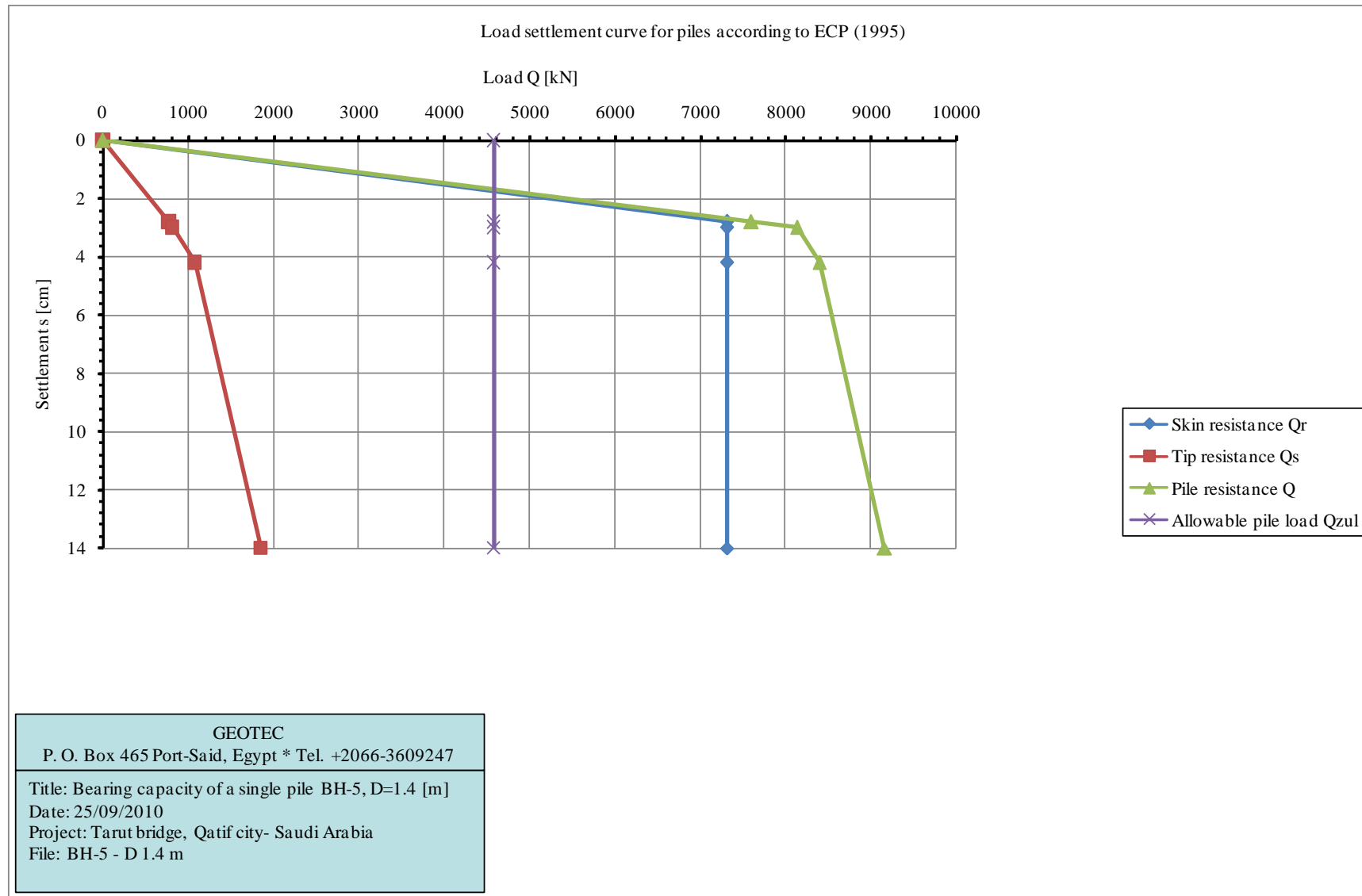

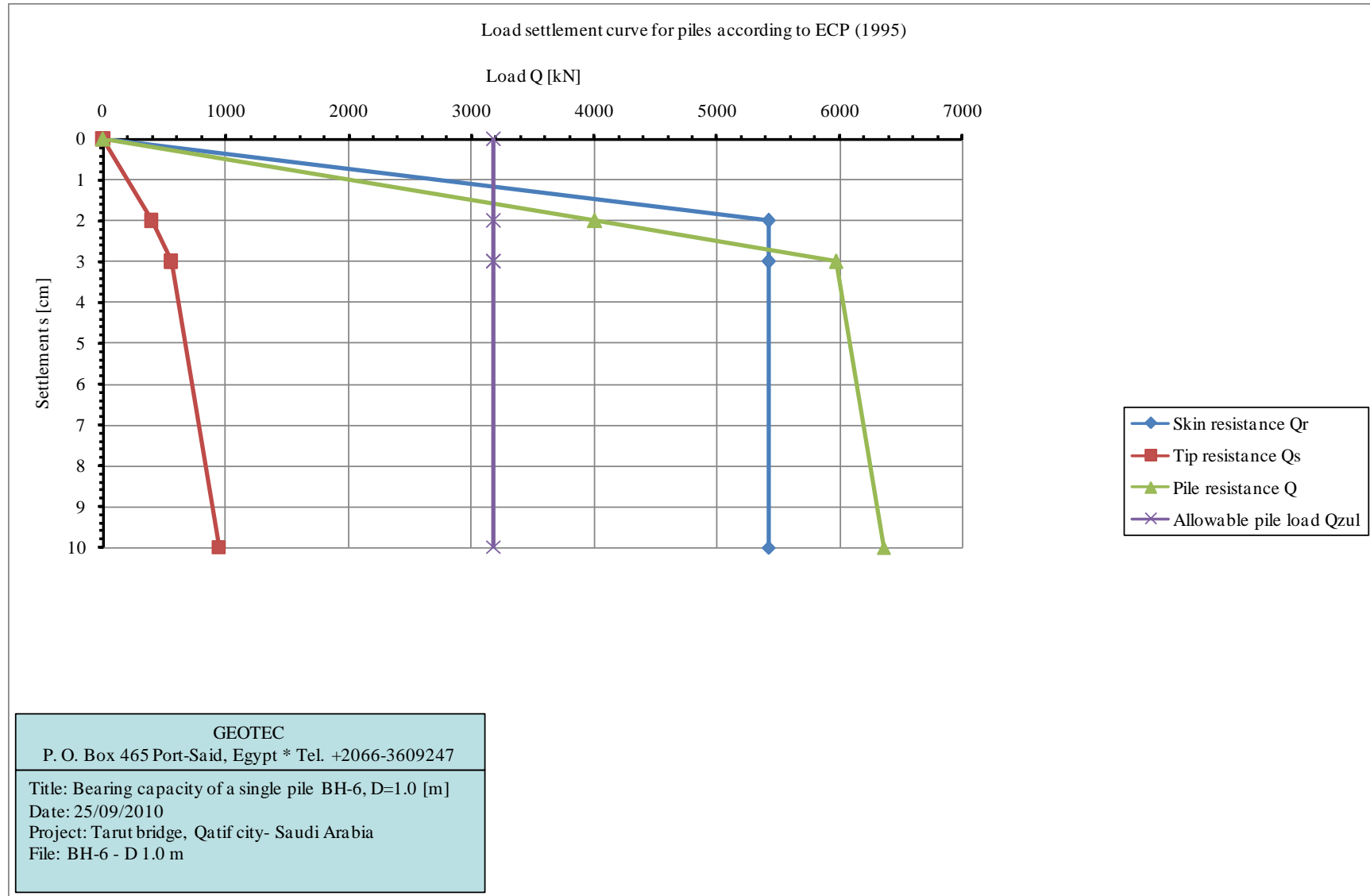

Tarut Bridge - Analysis and design of foundation

Summary of results

File tip resistance (Given)

s/Df = 0.02	Sig [kN/m2] = 500.000
s/Df = 0.03	Sig1 [kN/m2] = 700.000
s/Df = 0.10	SigGR [kN/m2] = 1200.000

Internal results

Skin friction:

Layer No.	Layer thickness [m]	Penetration tip resistance [kN/m2]	Undrainage cohesion of soil [kN/m2]	Skin friction Tau [kN/m2]	Friction force Qrg [kN]
1	3.00	-----	-----	35.000	395.8
2	4.50	-----	-----	45.000	763.4
3	4.50	-----	-----	60.000	1017.9
4	4.50	-----	-----	75.000	1272.3
5	3.00	-----	-----	45.000	508.9
6	5.00	-----	-----	100.000	1885.0
7	3.50	-----	-----	50.000	659.7

Sum of friction forces Qrf [kN] = 6503.1

Load on pile head Qma+Qsp = Qv [kN] = 2250.0
 Skin friction part from Qv Qma [kN] = 2037.4
 End bearing part from Qv Qsp [kN] = 212.6
Expected settlement sv [cm] = 0.94

File resistance depending on pile settlement:

No.	Referred settlement s/Df [-]	Pile tip settlement s [cm]	Pile friction resistance Qr [kN]	Tip resistance Qs [kN]	Pile resistance Q [kN]
1	0.02	2.40	5202.5	565.5	5768.0
2	0.03	3.00	6503.1	678.6	7181.7
3	0.03	3.60	6503.1	791.7	7294.8
4	0.10	12.00	6503.1	1357.2	7860.3 = Qg=2*Qzul

Final results:

Allowable settlement Szul [cm] = 1.64
Allowable pile load Qr+Qs = Qzul [kN] = 3930.1
 Skin friction part Qr [kN] = 3544.8
 End bearing part Qs [kN] = 385.3
 Safety factor Qzul/QV = ETHA [-] = 1.75

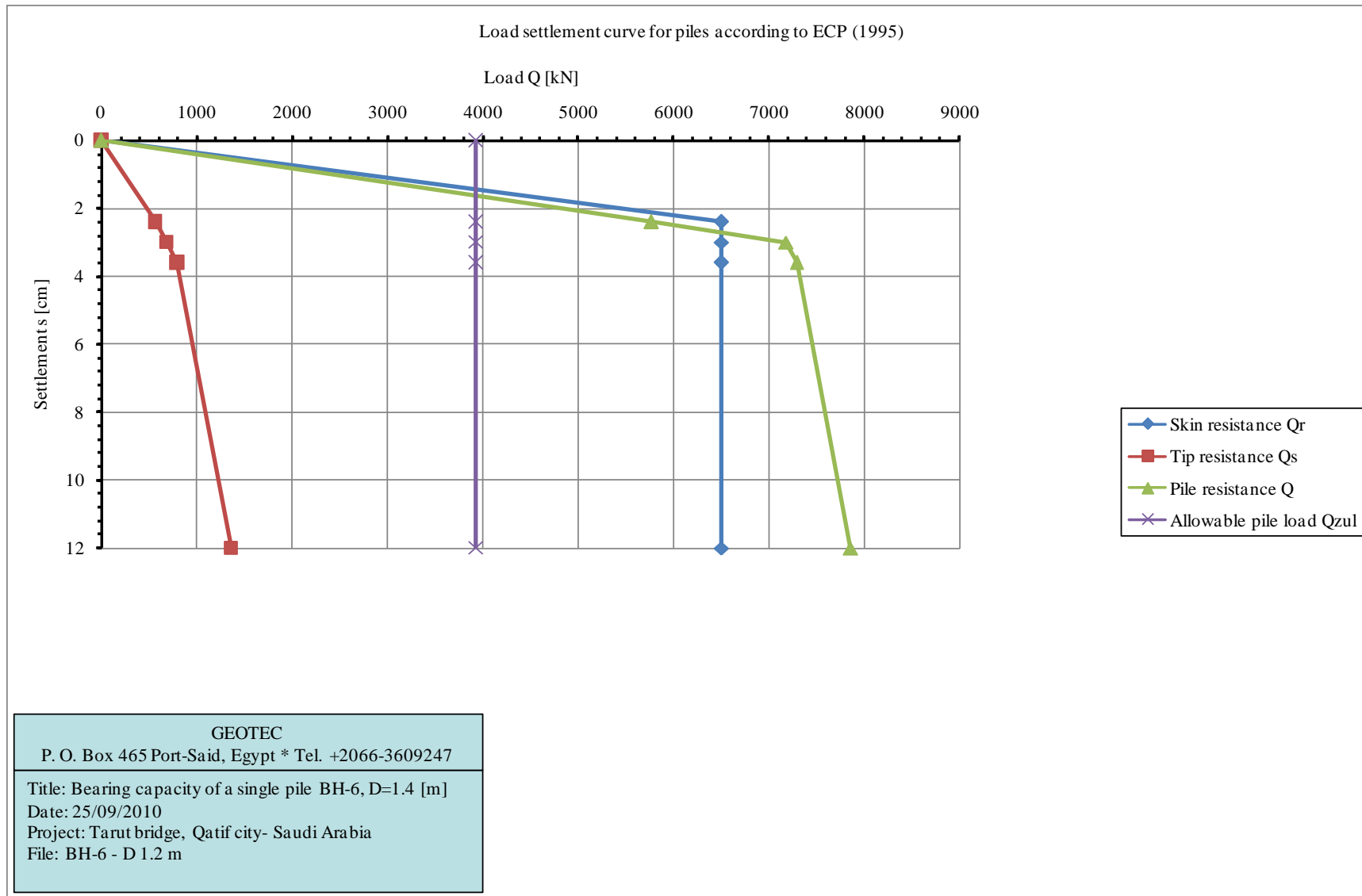

Tarut Bridge - Analysis and design of foundation

GeoTools
Version 2010

Program authors Prof. M. El Gendy/ Dr. A. El Gendy

Title: Bearing capacity of a single pile BH-6, D=1.4 [m]

Date: 25/09/2010

Project: Tarut bridge, Qatif city- Saudi Arabia

File: BH-6 - D 1.4 m

Bearing capacity and settlement of a single pile
according to ECP (1995)

Data:

File diameter		D	[m]	=	1.40
File toe diameter		Df	[m]	=	1.40
File length		Lg	[m]	=	28

Soil property

Layer	Layer Depth Under the SBL [m]	Soil Type	Av. SPT N Value	Bulk Unit Wt. [kN/m3]	Angle of Int. friction Φ [deg]	Undrainage cohesion Cu [kN/m2]	Modulus of Elasticity E [kN/m2]
1	0-3	CL-ML	1	15	-	50	7000
2	3-7.5	SM	30	18	35	-	38000
3	7.5-12	GM	>100	19.5	38	-	70000
4	12-16.5	SM	28	18	35	-	37000
5	16.5-19.5	CL	38	19	-	150	43000
6	19.5-24.5	SC-SM	48	19.5	31	-	48000
7	24.5-25	CL	>100	19.5	-	250	70000

Estimation of pile skin friction for non-cohesive soil

Layer	Soil Type	Layer Depth Under the SBL [m]	Angle of Int. friction Φ [deg]	Av. SPT N Value	Values according ECP (1995)		
					depth	SPT	Skin friction τ [kN/m2]
2	SM	3-7.5	35	30	2-7.5	20-30	45
3	GM	7.5-12	38	>100	2-10	>30	60
4	SM	12-16.5	35	28	>7.5	20-30	75
6	SC-SM	19.5-24.5	31	48	>10	>30	100

Estimation of pile skin friction for cohesive soil

Layer	Soil Type	Layer Depth Under the SBL [m]	Undrainage cohesion Cu [kN/m2]	Av. SPT N Value	Values according ECP (1995)	
					Undrainage cohesion Cu [kN/m2]	Skin friction τ [kN/m2]
1	CL-ML	0-3	50	1	50	35
5	CL	16.5-19.5	150	38	150	45
7	CL	24.5-25	250	>100	250	50

Tarut Bridge - Analysis and design of foundation

Summary of results

File tip resistance (Given)
 $s/D_f = 0.02$
 $s/D_f = 0.03$
 $s/D_f = 0.10$

Sig [kN/m²] = 500
 Sig1 [kN/m²] = 700
 SigGR [kN/m²] = 1200

Internal results

Skin friction:

Layer No.	Layer thickness [m]	Penetration tip resistance [kN/m ²]	Undrainage cohesion of soil Cu [kN/m ²]	Skin friction Tau [kN/m ²]	Friction force Qrg [kN]
1	3.00	-----	-----	35.000	461.8
2	4.50	-----	-----	45.000	890.6
3	4.50	-----	-----	60.000	1187.5
4	4.50	-----	-----	75.000	1484.4
5	3.00	-----	-----	45.000	593.8
6	5.00	-----	-----	100.000	2199.1
7	3.50	-----	-----	50.000	769.7

Sum of friction forces Qrf [kN] = 7586.9

Load on pile head Qma+Qsp = Qv [kN] = 2500.0
 Skin friction part from Qv Qma [kN] = 2257.9
 End bearing part from Qv Qsp [kN] = 242.1
Expected settlement sv [cm] = 0.89

File resistance depending on pile settlement:

No.	Referred settlement s/Df [-]	Pile tip settlement s [cm]	Pile friction resistance Qr [kN]	Tip resistance Qs [kN]	Pile resistance Q [kN]
1	0.02	2.80	7081.1	769.7	7850.8
2	0.02	3.00	7586.9	813.7	8400.6
3	0.03	4.20	7586.9	1077.6	8664.5
4	0.10	14.00	7586.9	1847.3	9434.2 = Qg=2*Qzul

Final results:

Allowable settlement Szul [cm] = 1.68
Allowable pile load Qr+Qs = Qzul [kN] = 4717.1
 Skin friction part Qr [kN] = 4254.6
 End bearing part Qs [kN] = 462.5
 Safety factor Qzul/QV = ETHA [-] = 1.89

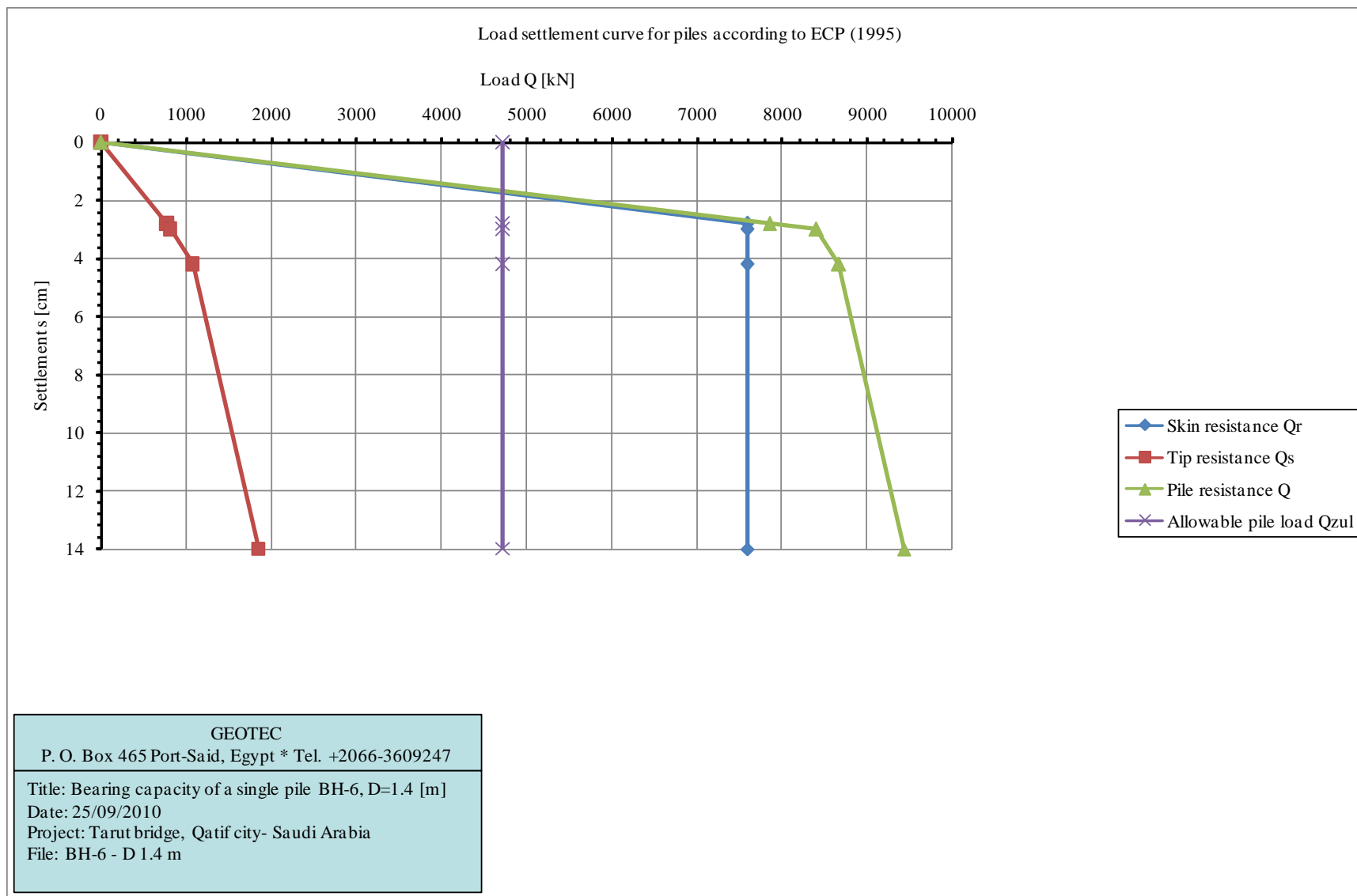

3 Offshore - Pile cap analysis

```
*****
Analysis of slab foundation
by the program package ELPLA
Version 9.2 SP1
*****
```

Title: Pile cap analysis
Date: 25/09/2010
Project: Tarut bridge, Qatif city- Saudi Arabia
File: Pile cap analysis

Calculation method:
Method (9) (Layered soil model)
Rigid free-standing raft

Program authors Prof. M. El Gendy/ Dr. A. El Gendy
GEOTEC Software Inc. PO Box 14001 Richmond Road PO, Calgary AB, Canada T3E 7Y7
www.geotecsoftware.com; geotec@geotecsoftware.com ; Tele.:+1(587) 332-3323

Tarut Bridge - Analysis and design of foundation

GEOTEC
PO Box 14001 Richmond Road PO, Calgary AB, Canada T3E 7Y7

Soil data

Title: Pile cap analysis
Date: 25/09/2010
Project: Tarut bridge, Qatif city- Saudi Arabia
File: Pile cap analysis

Analysis of slab foundation
by the program package ELPLA
Version 9.2 SP1

Calculation method:
Method (9) (Layered soil model)
Rigid free-standing raft

Soil data

Groundwater depth under the ground surface	GW	[m]	= 0
Settlement reduction factor	Alfa	[-]	= 1

B o r i n g l a y e r s

Boring log No.: 1
Boring Log Label: B1
Location of boring in global coordinates system

Xb	[m]	= 0.00
Yb	[m]	= 0.00

Layer No.: 1
Symbole for soil type and rocks after DIN 4023: T
Level of layer underground
Modulus of Elasticity of the soil (Loading)
Modulus of Elasticity of the soil (Reloading)
Poisson's ratio of soil
Unit weight of the soil
Angle of internal friction
Cohesion of the soil

z	[m]	= 3.00
E	[kN/m2]	= 7000.0
W	[kN/m2]	= 7000.0
Nue	[-]	= 0.30
Gama	[kN/m3]	= 5.2
Fhi	[°]	= 0.00
c	[kN/m2]	= 50.0

Layer No.: 2
Symbole for soil type and rocks after DIN 4023: S+U
Level of layer underground
Modulus of Elasticity of the soil (Loading)
Modulus of Elasticity of the soil (Reloading)
Poisson's ratio of soil
Unit weight of the soil
Angle of internal friction
Cohesion of the soil

z	[m]	= 7.50
E	[kN/m2]	= 38000.0
W	[kN/m2]	= 38000.0
Nue	[-]	= 0.30
Gama	[kN/m3]	= 8.2
Fhi	[°]	= 35.00
c	[kN/m2]	= 0.0

Layer No.: 3
Symbole for soil type and rocks after DIN 4023: G+U
Level of layer underground
Modulus of Elasticity of the soil (Loading)
Modulus of Elasticity of the soil (Reloading)
Poisson's ratio of soil
Unit weight of the soil
Angle of internal friction
Cohesion of the soil

z	[m]	= 12.00
E	[kN/m2]	= 70000.0
W	[kN/m2]	= 70000.0
Nue	[-]	= 0.30
Gama	[kN/m3]	= 9.7
Fhi	[°]	= 38.00
c	[kN/m2]	= 0.0

Layer No.: 4
 Symbole for soil type and rocks after DIN 4023: S+U
 Level of layer underground z [m] = 15.00
 Modulus of Elasticity of the soil (Loading) E [kN/m2] = 37000.0
 Modulus of Elasticity of the soil (Reloading) W [kN/m2] = 37000.0
 Poisson's ratio of soil Nue [-] = 0.30
 Unit weight of the soil Gama [kN/m3] = 8.2
 Angle of internal friction Fhi [°] = 35.00
 Cohesion of the soil c [kN/m2] = 0.0

Layer No.: 5
 Symbole for soil type and rocks after DIN 4023: T
 Level of layer underground z [m] = 18.00
 Modulus of Elasticity of the soil (Loading) E [kN/m2] = 43000.0
 Modulus of Elasticity of the soil (Reloading) W [kN/m2] = 43000.0
 Poisson's ratio of soil Nue [-] = 0.30
 Unit weight of the soil Gama [kN/m3] = 9.2
 Angle of internal friction Fhi [°] = 0.00
 Cohesion of the soil c [kN/m2] = 150.0

Layer No.: 6
 Symbole for soil type and rocks after DIN 4023: S+T
 Level of layer underground z [m] = 22.50
 Modulus of Elasticity of the soil (Loading) E [kN/m2] = 48000.0
 Modulus of Elasticity of the soil (Reloading) W [kN/m2] = 48000.0
 Poisson's ratio of soil Nue [-] = 0.30
 Unit weight of the soil Gama [kN/m3] = 9.7
 Angle of internal friction Fhi [°] = 31.00
 Cohesion of the soil c [kN/m2] = 0.0

Layer No.: 7
 Symbole for soil type and rocks after DIN 4023: T
 Level of layer underground z [m] = 50.00
 Modulus of Elasticity of the soil (Loading) E [kN/m2] = 70000.0
 Modulus of Elasticity of the soil (Reloading) W [kN/m2] = 70000.0
 Poisson's ratio of soil Nue [-] = 0.30
 Unit weight of the soil Gama [kN/m3] = 9.7
 Angle of internal friction Fhi [°] = 0.00
 Cohesion of the soil c [kN/m2] = 250.0

Tarut Bridge - Analysis and design of foundation

GEOTEC
PO Box 14001 Richmond Road PO, Calgary AB, Canada T3E 7Y7

Slab properties/ Foundation level/ Global coordinates

Title: Pile cap analysis
Date: 25/09/2010
Project: Tarut bridge, Qatif city- Saudi Arabia
File: Pile cap analysis

Analysis of slab foundation
by the program package ELPLA
Version 9.2 SP1

Calculation method:
Method (9) (Layered soil model)
Rigid free-standing raft

Slab properties/ Foundation level/ Global coordinates

Unit weight of slab material GB [kN/m3] = 25.0

Element groups (with the same thickness and material):

Group No.	E-Modulus of slab Ep [kN/m2]	Poisson's ratio Nue [-]	Slab thickness d [m]
1	2.4E+07	0.2	1.25

Tarut Bridge - Analysis and design of foundation

GEOTEC
PO Box 14001 Richmond Road PO, Calgary AB, Canada T3E 7Y7

----- Loads -----

Title: Pile cap analysis
Date: 25/09/2010
Project: Tarut bridge, Qatif city- Saudi Arabia
File: Pile cap analysis

Analysis of slab foundation
by the program package ELPLA
Version 9.2 SP1

Calculation method:
Method (9) (Layered soil model)
Rigid free-standing raft

L o a d i n g

Column types (with the same properties):

Group No.	Column side	Column side
I	a	b
[-]	[m]	[m]
1	1.11	1.11

Point loads:

Load No.	Column types	Load value	X-coord.	Y-coord.
I	I	P	x	y
[-]	[-]	[kN]	[m]	[m]
1	1	6000	13	3
2	1	5500	3	3
3	1	5500	23	3

Tarut Bridge - Analysis and design of foundation

GEOTEC
PO Box 14001 Richmond Road PO, Calgary AB, Canada T3E 7Y7

Loads

Loading data:

Distribute column loads: (Yes)

Slab weight	Pe	[kN]	=	4875
Force on slab	Pa	[kN]	=	37344
Groundwater force	Pw	[kN]	=	0
Total load ($P = Pe + Pa - Pw$)	P	[kN]	=	42219
Groundwater pressure on raft	Qw	[kN/m ²]	=	0.0
Average contact pressure	Qo	[kN/m ²]	=	270.6

Sum Mx from loads	Mx	[kN.m]	=	-0.3
Sum My from loads	My	[kN.m]	=	-1.7

Eccentricity of loading in x-direction	ex	[cm]	=	0.00
Eccentricity of loading in y-direction	ey	[cm]	=	0.00

Moment of inertia of slab about x-Axis	Ix	[m ⁴]	=	468.00
Moment of inertia of slab about y-Axis	Iy	[m ⁴]	=	8788.01
Product of inertia	Ixy	[m ⁴]	=	0.00
Area of the slab	A	[m ²]	=	156.00
Volume of the slab	V	[m ³]	=	195.00

Tarut Bridge - Analysis and design of foundation

GEOTEC
PO Box 14001 Richmond Road PO, Calgary AB, Canada T3E 7Y7

Data of piles

Title: Pile cap analysis
Date: 25/09/2010
Project: Tarut bridge, Qatif city- Saudi Arabia
File: Pile cap analysis

Analysis of slab foundation
by the program package ELPLA
Version 9.2 SP1

Calculation method:
Method (9) (Layered soil model)
Rigid free-standing raft

File groups:

Group No.: 1
Description of pile groups: P1
File diameter D [m] = 1.4
File toe diameter Df [m] = 1.4
File length Lg [m] = 28

Soil data under the pile tip:
File tip resistance (s/Df = 0.02) Sig [kN/m2] = 500
File tip resistance (s/Df = 0.03) Sig1 [kN/m2] = 700
File tip resistance (s/Df = 0.1) SigGR [kN/m2] = 1200

Geotechnical data of the layer:

Layer No.	Layer thickness	Undrainage cohesion	Penetration resistance	Skin friction
I	L1	Cu	qs	Tau
[-]	[m]	[kN/m2]	[kN/m2]	[kN/m2]
1	3.00	---	---	35.0
2	4.50	---	---	45.0
3	4.50	---	---	60.0
4	3.00	---	---	75.0
5	3.00	---	---	45.0
6	4.50	---	---	100.0
7	5.50	---	---	50.0

Tarut Bridge - Analysis and design of foundation

File locations and groups:

File No. [-]	Node No. [-]	X-coord. [m]	Y-coord. [m]	Group No. [-]
1	197	1.50	1.50	1
2	449	1.50	4.50	1
3	202	4.75	1.50	1
4	454	4.75	4.50	1
5	207	8.00	1.50	1
6	459	8.00	4.50	1
7	212	11.25	1.50	1
8	464	11.25	4.50	1
9	219	14.75	1.50	1
10	471	14.75	4.50	1
11	224	18.00	1.50	1
12	476	18.00	4.50	1
13	229	21.25	1.50	1
14	481	21.25	4.50	1
15	234	24.50	1.50	1
16	486	24.50	4.50	1

File material:

Modulus of elasticity of pile E_p [kN/m²] = 24000000
Unit weight of pile concrete GP [kN/m³] = 29.50
The 5 m pile length above the bed level is considered by assuming
an equivalent unit weight of pile concrete)

Tarut Bridge - Analysis and design of foundation

GEOTEC
PO Box 14001 Richmond Road PO, Calgary AB, Canada T3E 7Y7

Support reactions

Title: Pile cap analysis
Date: 25/09/2010
Project: Tarut bridge, Qatif city- Saudi Arabia
File: Pile cap analysis

Analysis of slab foundation
by the program package ELPLA
Version 9.2 SP1

Calculation method:
Method (9) (Layered soil model)
Rigid free-standing raft

Support reactions

Node No.	Load-V	Moment-Y	Moment-X
I	V	My	Mx
[-]	[kN]	[kN.m]	[kN.m]
197	2962	0	0
202	2648	0	0
207	2500	0	0
212	2445	0	0
219	2445	0	0
224	2500	0	0
229	2648	0	0
234	2962	0	0
449	2962	0	0
454	2648	0	0
459	2500	0	0
464	2445	0	0
471	2445	0	0
476	2500	0	0
481	2648	0	0
486	2962	0	0

Sum. V 42219

Tarut Bridge - Analysis and design of foundation

GEOTEC
PO Box 14001 Richmond Road PO, Calgary AB, Canada T3E 7Y7

Pile results

Title: Pile cap analysis
Date: 25/09/2010
Project: Tarut bridge, Qatif city- Saudi Arabia
File: Pile cap analysis

Analysis of slab foundation
by the program package ELPLA
Version 9.2 SP1

Calculation method:
Method (9) (Layered soil model)
Rigid free-standing raft

Pile results

Value of total load (including own wt.) Po [kN] = 42219
Total pile loads PL [kN] = 42219
Bearing factor of piled raft Alfa-Kpp [%] = 100.00

Pile loads and displacements

Pile No.	pile load	Settlement	Soil stiffness
I	Fr	Sr	ks
[-]	[kN]	[cm]	[kN/m]
1	2962	1.68	176360.8
2	2962	1.68	176360.8
3	2648	1.68	157700.8
4	2648	1.68	157700.8
5	2500	1.68	148899.1
6	2500	1.68	148899.2
7	2445	1.68	145577.4
8	2445	1.68	145577.4
9	2445	1.68	145577.4
10	2445	1.68	145577.4
11	2500	1.68	148899.2
12	2500	1.68	148899.2
13	2648	1.68	157700.8
14	2648	1.68	157700.8
15	2962	1.68	176360.7
16	2962	1.68	176360.8

Tarut Bridge - Analysis and design of foundation

File loads

File No.	Skin resistance Qma [kN]	Tip resistance Qsp [kN]	Total load Fr [kN]
1	2585	288	2962
2	2585	288	2962
3	2382	265	2648
4	2382	265	2648
5	2284	254	2500
6	2284	254	2500
7	2246	250	2445
8	2246	250	2445
9	2246	250	2445
10	2246	250	2445
11	2284	254	2500
12	2284	254	2500
13	2382	265	2648
14	2382	265	2648
15	2585	288	2962
16	2585	288	2962

File settlements

File No.	Self settlement Sv [cm]	Settlement Sr-Sv [cm]	Sum of settlements Sr [cm]
1	1.06	0.62	1.68
2	1.06	0.62	1.68
3	0.98	0.70	1.68
4	0.98	0.70	1.68
5	0.94	0.74	1.68
6	0.94	0.74	1.68
7	0.92	0.76	1.68
8	0.92	0.76	1.68
9	0.92	0.76	1.68
10	0.92	0.76	1.68
11	0.94	0.74	1.68
12	0.94	0.74	1.68
13	0.98	0.70	1.68
14	0.98	0.70	1.68
15	1.06	0.62	1.68
16	1.06	0.62	1.68

Tarut Bridge - Analysis and design of foundation

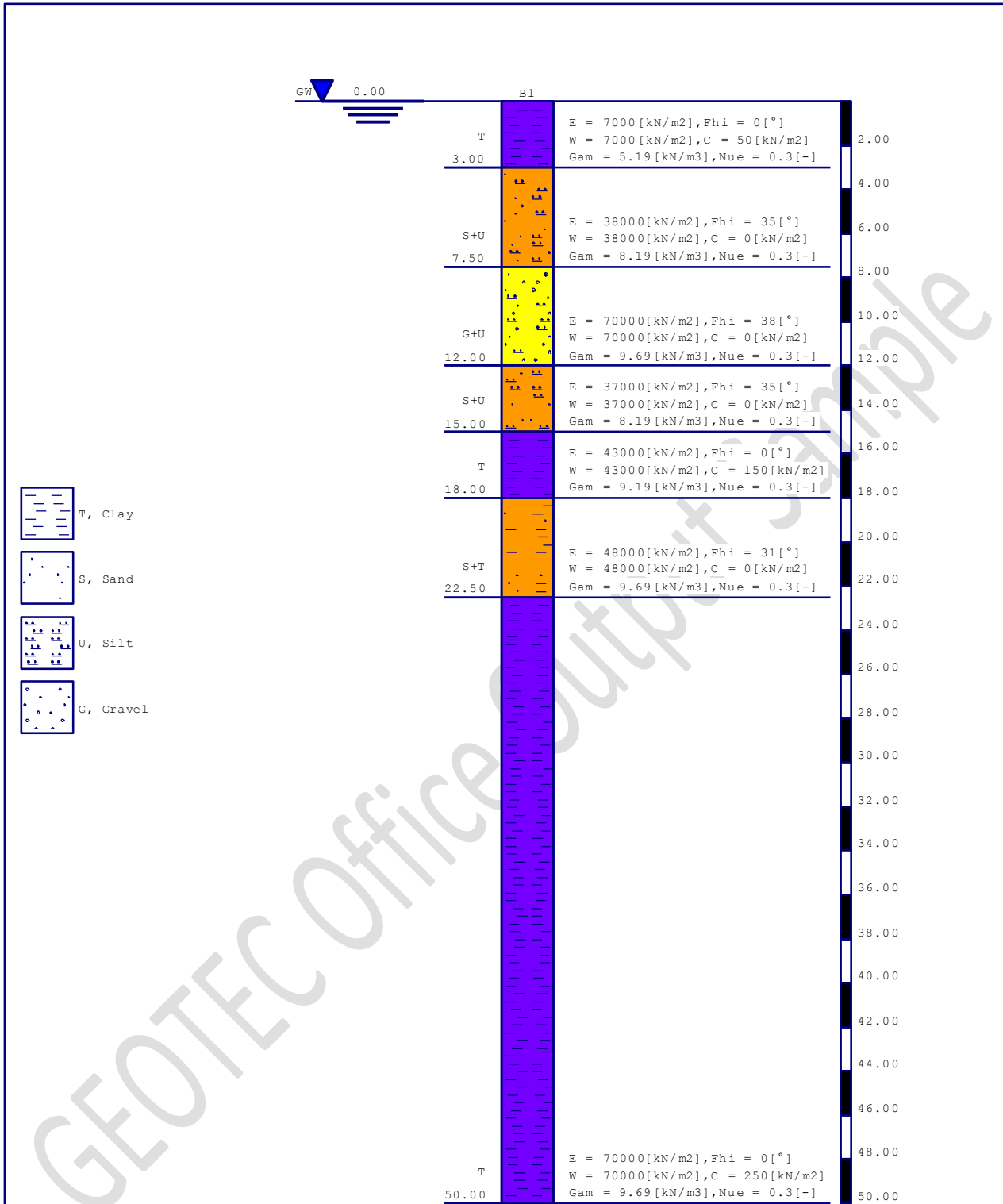

Boring Logs

GEOTEC P. O. Box 465, Port-Said, Egypt* Tel. +2066-3609247	
Scale 1:235 File: Pile cap analysis Page No.:	Title: Pile cap analysis Date: 25/09/2010 Project: Tarut bridge, Qatif city- Saudi Arabia

Method (9) (Layered soil model)
Rigid free-standing raft

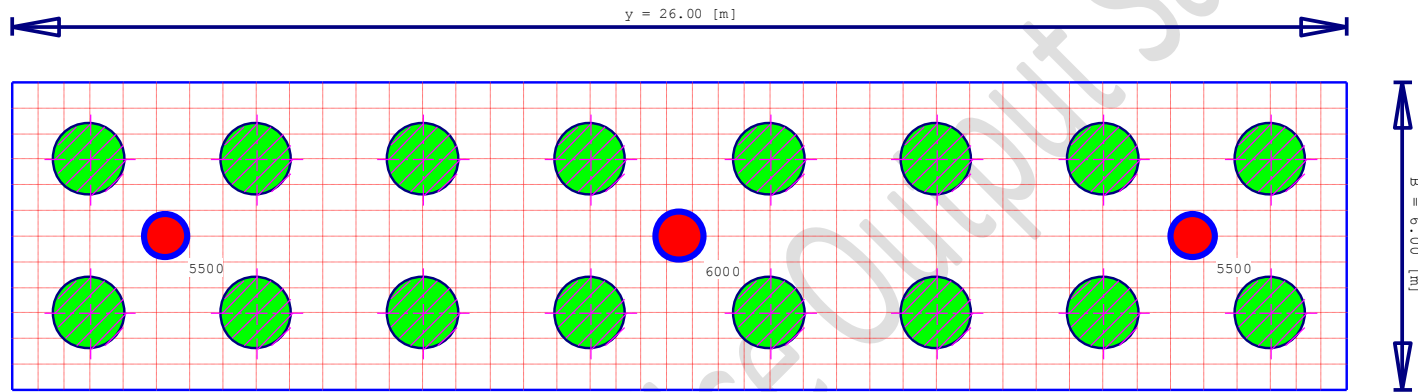

Pile locations and coulmn loads [kN]

GEOTEC

P. O. Box 465, Port-Said, Egypt* Tel. +2066-3609247

Scale 1:120

File: Pile cap analysis

Page No.:

Title: Pile cap analysis

Date: 25/09/2010

Project: Tarut bridge, Qatif city- Saudi Arabia

Method (9) (Layered soil model)
Rigid free-standing raft

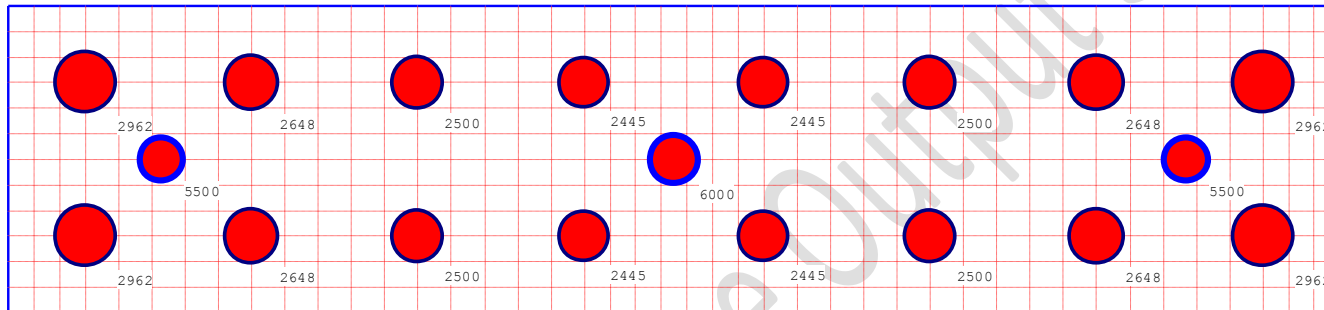

Pile reactions V and column loads [kN]
Max. $V = 2962$, Min. $V = 2445$, Sum = 42219

GEOTEC

P. O. Box 465, Port-Said, Egypt* Tel. +2066-3609247

Scale 1:120

File: Pile cap analysis

Page No.:

Title: Pile cap analysis

Date: 25/09/2010

Project: Tarut bridge, Qatif city- Saudi Arabia

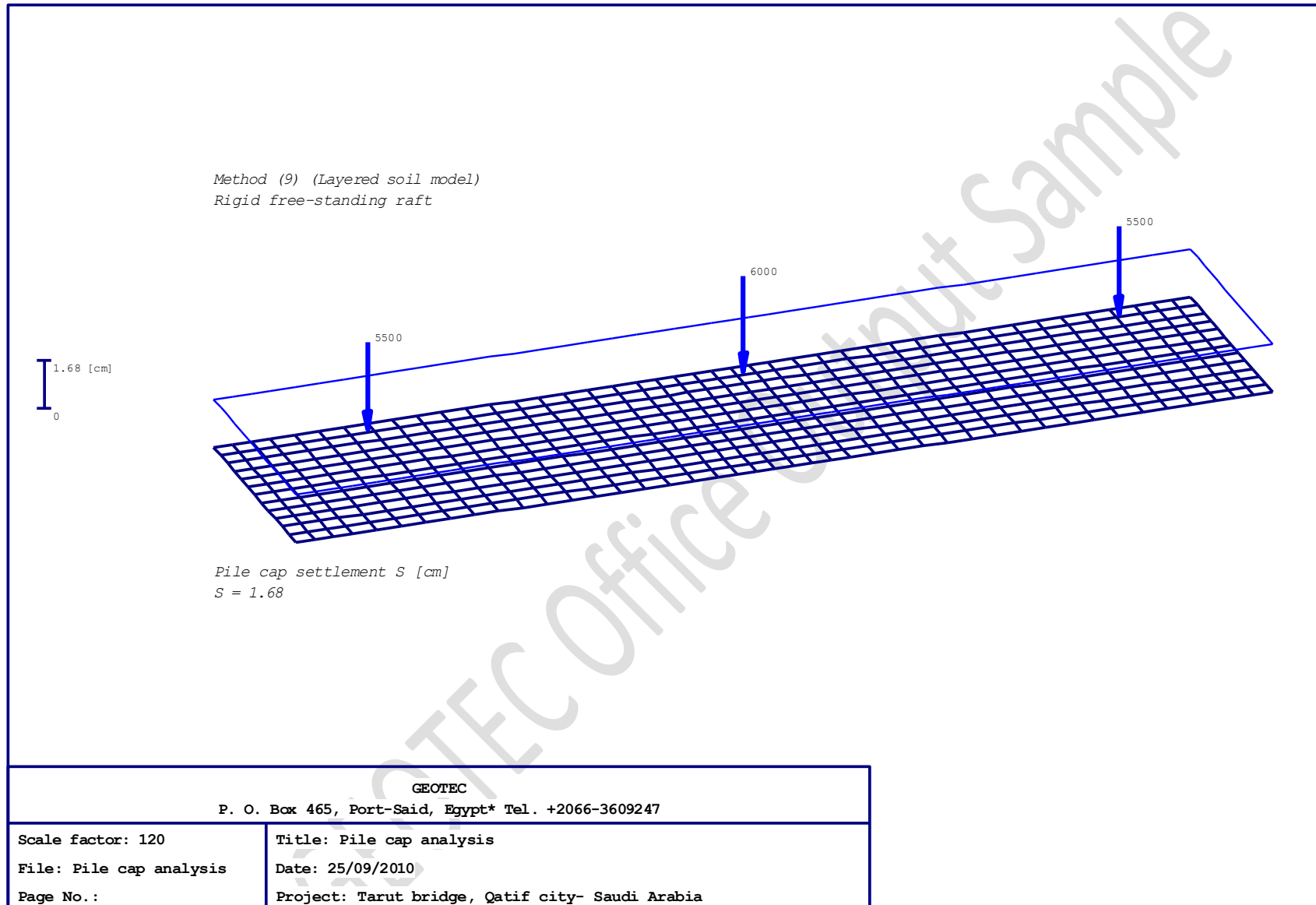

4 Offshore - Pile cap design

```
*****
Analysis of slab foundation
by the program package ELPLA
Version 9.2 SP1
*****
```

```
Title: Pile cap design
Date: 25/09/2010
Project: Tarut bridge, Qatif city- Saudi Arabia
File: Pile cap design
```

```
Calculation method:
Method (3)
Modulus of subgrade reaction is defined by the user
```

```
Program authors Prof. M. El Gendy/ Dr. A. El Gendy
GEOTEC Software Inc. PO Box 14001 Richmond Road PO, Calgary AB, Canada T3E 7Y7
www.geotecsoftware.com; geotec@geotecsoftware.com ; Tele.:+1(587) 332-3323
```

Tarut Bridge - Analysis and design of foundation

GEOTEC
PO Box 14001 Richmond Road PO, Calgary AB, Canada T3E 7Y7

Slab properties/ Foundation level/ Global coordinates

Title: Pile cap design
Date: 25/09/2010
Project: Tarut bridge, Qatif city- Saudi Arabia
File: Pile cap design

Analysis of slab foundation
by the program package ELPLA
Version 9.2 SP1

Calculation method:
Method (3)
Modulus of subgrade reaction is defined by the user

Slab properties/ Foundation level/ Global coordinates

Unit weight of slab material GB [kN/m3] = 25.0

Element groups (with the same thickness and material):

Group No.	E-Modulus of slab Ep [kN/m2]	Poisson's ratio Nue [-]	Slab thickness d [m]
1	2.4E+07	0.2	1.25

Tarut Bridge - Analysis and design of foundation

GEOTEC
PO Box 14001 Richmond Road PO, Calgary AB, Canada T3E 7Y7

----- Loads -----

Title: Pile cap design
Date: 25/09/2010
Project: Tarut bridge, Qatif city- Saudi Arabia
File: Pile cap design

Analysis of slab foundation
by the program package ELPLA
Version 9.2 SP1

Calculation method:
Method (3)
Modulus of subgrade reaction is defined by the user

L o a d i n g

Column types (with the same properties):

Group No. I [-]	Column side a [m]	Column side b [m]
1	1.11	1.11

Point loads:

Load No. I [-]	Column types I [-]	Load value P [kN]	X-coord. x [m]	Y-coord. y [m]
1	1	6000	13	3
2	1	5500	3	3
3	1	5500	23	3

Tarut Bridge - Analysis and design of foundation

GEOTEC
PO Box 14001 Richmond Road PO, Calgary AB, Canada T3E 7Y7

Loads

Loading data:

Distribute column loads: (Yes)

Slab weight	Pe [kN]	= 4875
Force on slab	Pa [kN]	= 37344
Groundwater force	Pw [kN]	= 0
Total load ($P = Pe + Pa - Pw$)	P [kN]	= 42219
Groundwater pressure on raft	Qw [kN/m ²]	= 0.0
Average contact pressure	Qo [kN/m ²]	= 270.6

Sum Mx from loads	Mx [kN.m]	= -0.3
Sum My from loads	My [kN.m]	= -1.7

Eccentricity of loading in x-direction	ex [cm]	= 0.00
Eccentricity of loading in y-direction	ey [cm]	= 0.00

Moment of inertia of slab about x-Axis	Ix [m ⁴]	= 468.00
Moment of inertia of slab about y-Axis	Iy [m ⁴]	= 8788.01
Product of inertia	Ixy [m ⁴]	= 0.00
Area of the slab	A [m ²]	= 156.00
Volume of the slab	V [m ³]	= 195.00

Tarut Bridge - Analysis and design of foundation

GEOTEC
PO Box 14001 Richmond Road PO, Calgary AB, Canada T3E 7Y7

Data of reinforcement

Title: Pile cap design
Date: 25/09/2010
Project: Tarut bridge, Qatif city- Saudi Arabia
File: Pile cap design

Analysis of slab foundation
by the program package ELPLA
Version 9.2 SP1

Calculation method:
Method (3)
Modulus of subgrade reaction is defined by the user

Data of reinforcement (Design for flexural moment)

Design Code
Concrete grade C 300
Steel Grade S 36/52

Compressive strength fc [kN/m²] = 10500
Tensile strength fs [kN/m²] = 200000

Concrete cover+ 1/2 bar diameter
X-direction top d1x [cm] = 7
X-direction bottom d2x [cm] = 7
Y-direction top d1y [cm] = 7
Y-direction bottom d2y [cm] = 7

Tarut Bridge - Analysis and design of foundation

GEOTEC
PO Box 14001 Richmond Road PO, Calgary AB, Canada T3E 7Y7

Data of piles

Title: Pile cap design
Date: 25/09/2010
Project: Tarut bridge, Qatif city- Saudi Arabia
File: Pile cap design

Analysis of slab foundation
by the program package ELPLA
Version 9.2 SP1

Calculation method:
Method (3)
Modulus of subgrade reaction is defined by the user

File groups:

Group No.	Pile diameter D [m]	Pile length L [m]	Pile stiffness kz [kN/m]
1	1.40	28.00	176361.0
2	1.40	28.00	157701.0
3	1.40	28.00	148899.0
4	1.40	28.00	145577.0

File locations and groups:

Pile No.	Node No.	X-coord. [m]	Y-coord. [m]	Group No.
1	449	1.50	4.50	1
2	197	1.50	1.50	1
3	234	24.50	1.50	1
4	486	24.50	4.50	1
5	454	4.75	4.50	2
6	202	4.75	1.50	2
7	481	21.25	4.50	2
8	229	21.25	1.50	2
9	459	8.00	4.50	3
10	207	8.00	1.50	3
11	476	18.00	4.50	3
12	224	18.00	1.50	3
13	464	11.25	4.50	4
14	212	11.25	1.50	4
15	471	14.75	4.50	4
16	219	14.75	1.50	4

File material:
Modulus of elasticity of pile E_p [kN/m²] = 24000000
Unit weight of pile concrete GP [kN/m³] = 29.50
The 5 m pile length above the bed level is considered by assuming an equivalent unit weight of pile concrete)

Tarut Bridge - Analysis and design of foundation

GEOTEC
PO Box 14001 Richmond Road PO, Calgary AB, Canada T3E 7Y7

Support reactions

Title: Pile cap design
Date: 25/09/2010
Project: Tarut bridge, Qatif city- Saudi Arabia
File: Pile cap design

Analysis of slab foundation
by the program package ELPLA
Version 9.2 SP1

Calculation method:
Method (3)
Modulus of subgrade reaction is defined by the user

Support reactions

Node No.	Load-V	Moment-Y	Moment-X
I	V	My	Mx
[-]	[kN]	[kN.m]	[kN.m]
197	2955	0	0
202	2612	0	0
207	2444	0	0
212	2483	0	0
219	2481	0	0
224	2438	0	0
229	2607	0	0
234	2954	0	0
449	2926	0	0
454	2586	0	0
459	2420	0	0
464	2460	0	0
471	2462	0	0
476	2423	0	0
481	2594	0	0
486	2943	0	0
Sum. V	41788		

Tarut Bridge - Analysis and design of foundation

GEOTEC
PO Box 14001 Richmond Road PO, Calgary AB, Canada T3E 7Y7

File results

Title: Pile cap design
Date: 25/09/2010
Project: Tarut bridge, Qatif city- Saudi Arabia
File: Pile cap design

Analysis of slab foundation
by the program package ELPLA
Version 9.2 SP1

Calculation method:
Method (3)
Modulus of subgrade reaction is defined by the user

File results

Value of total load (including own wt.) Po [kN] = 42219
Total pile loads PL [kN] = 41788
Bearing factor of piled raft Alfa-Kpp [%] = 98.98

File loads and displacements

Pile No.	pile load Fr [kN]	Settlement Sr [cm]	Soil stiffness ks [kN/m]
1	2926	1.66	176361.0
2	2955	1.68	176361.0
3	2954	1.68	176361.0
4	2943	1.67	176361.0
5	2586	1.64	157701.0
6	2612	1.66	157701.0
7	2594	1.65	157701.0
8	2607	1.65	157701.0
9	2420	1.62	148899.0
10	2444	1.64	148899.0
11	2423	1.63	148899.0
12	2438	1.64	148899.0
13	2460	1.69	145577.0
14	2483	1.71	145577.0
15	2462	1.69	145577.0
16	2481	1.70	145577.0

Tarut Bridge - Analysis and design of foundation

Punching Shear

Node No.	Load value	X-coord.	Y-coord.	Column side or diameter	Column side	Punching shear stress	Stress on the column	Area of critical section of punching shear PA [m ²]	Perimeter of critical section of punching shear AL [m]	Effective depth of the section of punching shear Dp [m]	Punching shear stress ratio
I [-]	Pc [kN]	Xc [m]	Yc [m]	a [m]	b [m]	Qp [kN/m ²]	Qo [kN/m ²]				Rpa [%]
1	6000	13	3	1.11	1.11	869.3	-647.5	5.24	9.16	1.18	1.15
2	5500	3	3	1.11	1.11	880.3	-765.6	5.24	9.16	1.18	1.14
3	5500	23	3	1.11	1.11	880.3	-765.6	5.24	9.16	1.18	1.14
4	2926	1.5	4.5	1.4	0	271.6	67.6	5.09	8.05	1.18	1.84
5	2955	1.5	1.5	1.4	0	274.7	67.6	5.09	8.05	1.18	1.82
6	2954	24.5	1.5	1.4	0	274.6	67.6	5.09	8.05	1.18	1.82
7	2943	24.5	4.5	1.4	0	273.4	67.6	5.09	8.05	1.18	1.83
8	2586	4.75	4.5	1.4	0	235.9	67.6	5.09	8.05	1.18	2.12
9	2612	4.75	1.5	1.4	0	238.6	67.6	5.09	8.05	1.18	2.1
10	2594	21.25	4.5	1.4	0	236.7	67.6	5.09	8.05	1.18	2.11
11	2607	21.25	1.5	1.4	0	238	67.6	5.09	8.05	1.18	2.1
12	2420	8	4.5	1.4	0	237.9	31.3	5.09	8.05	1.18	2.1
13	2444	8	1.5	1.4	0	240.4	31.3	5.09	8.05	1.18	2.08
14	2423	18	4.5	1.4	0	238.3	31.3	5.09	8.05	1.18	2.1
15	2438	18	1.5	1.4	0	239.8	31.2	5.09	8.05	1.18	2.08
16	2460	11.25	4.5	1.4	0	239.1	36.8	5.09	8.05	1.18	2.09
17	2483	11.25	1.5	1.4	0	241.5	36.8	5.09	8.05	1.18	2.07
18	2462	14.75	4.5	1.4	0	239.3	36.8	5.09	8.05	1.18	2.09
19	2481	14.75	1.5	1.4	0	241.4	36.8	5.09	8.05	1.18	2.07

Tarut Bridge - Analysis and design of foundation

Method (2)

Modulus of subgrade reaction is defined by the user

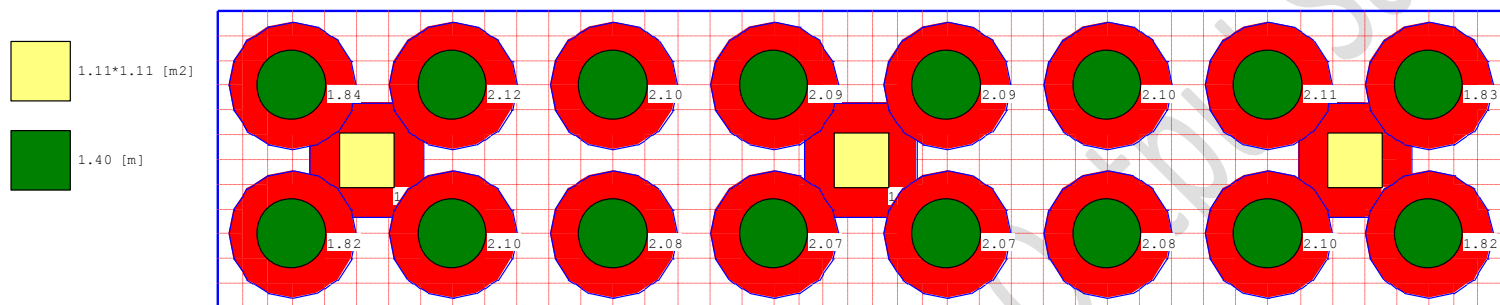

Punching shear stress ratio R_{pa} [%]

Max. R_{pa} = 2.12 at column 8, Min. R_{pa} = 1.14 at column 2

GEOTEC

P. O. Bx 465, Port-Said, Egypt* Tel. +2066-3609247

Scale 1:120

File: Pile cap design

Page No. :

Title: Pile cap design

Date: 25/09/2010

Project: Tarut bridge, Qatif city- Saudi Arabia

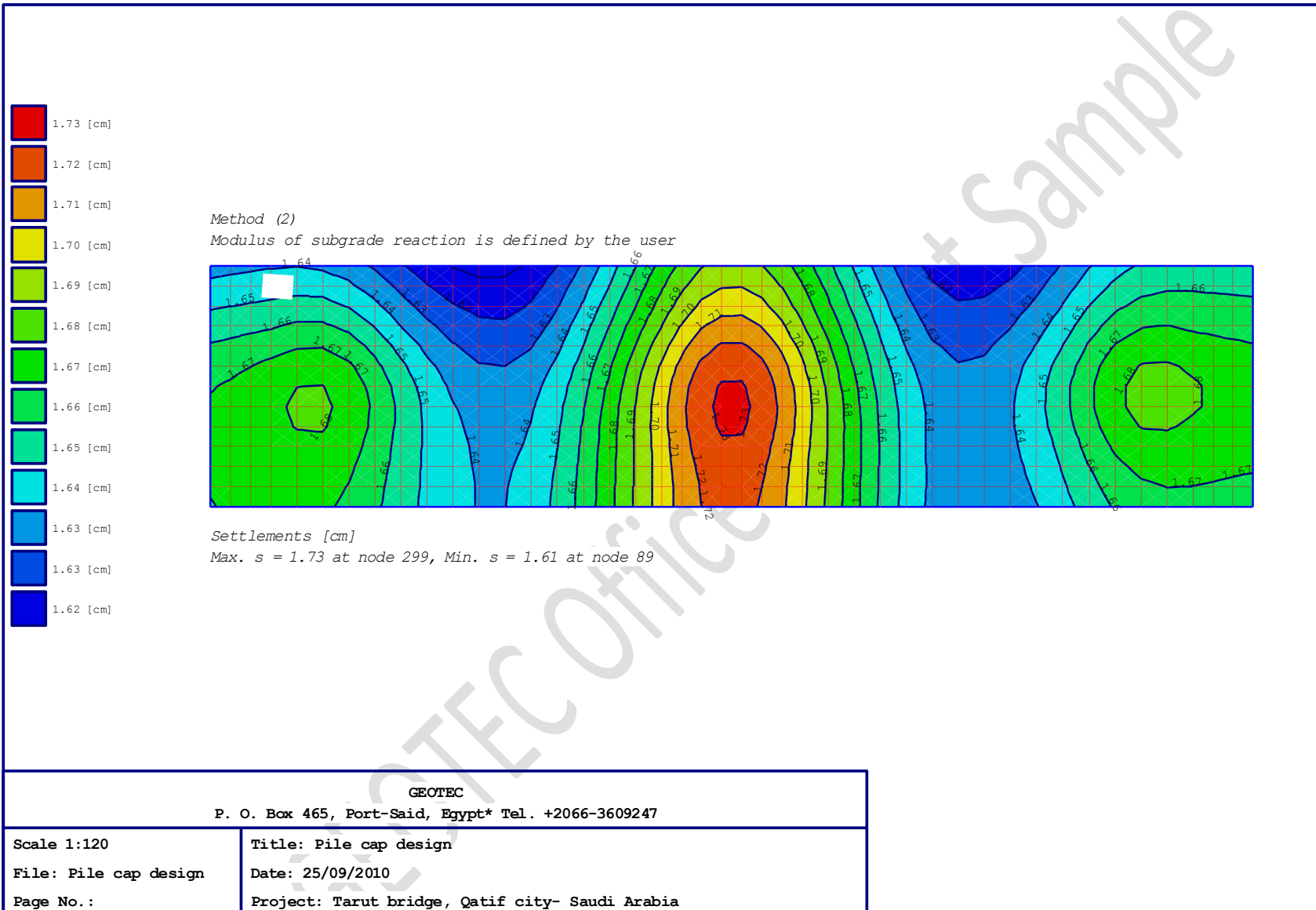

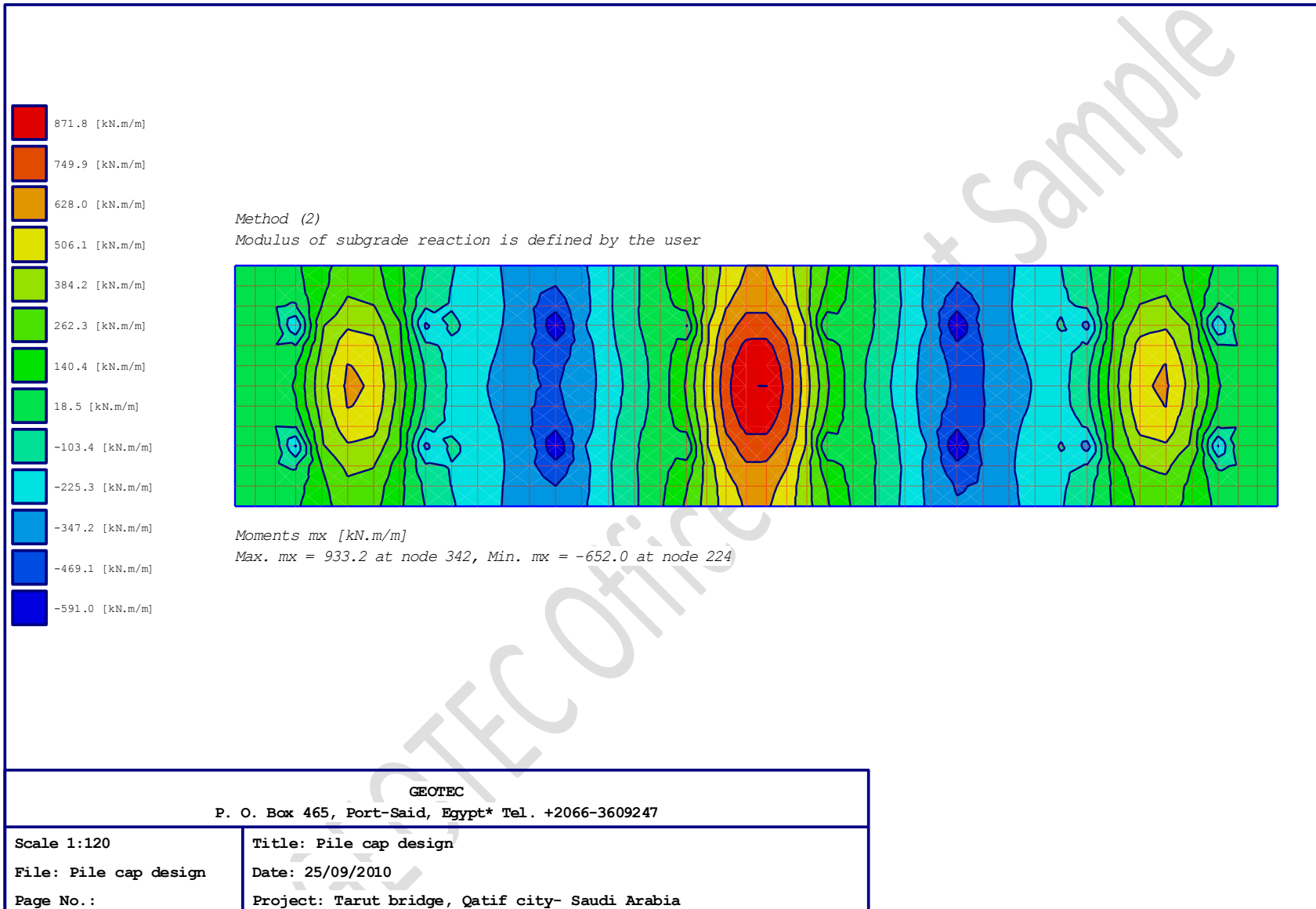

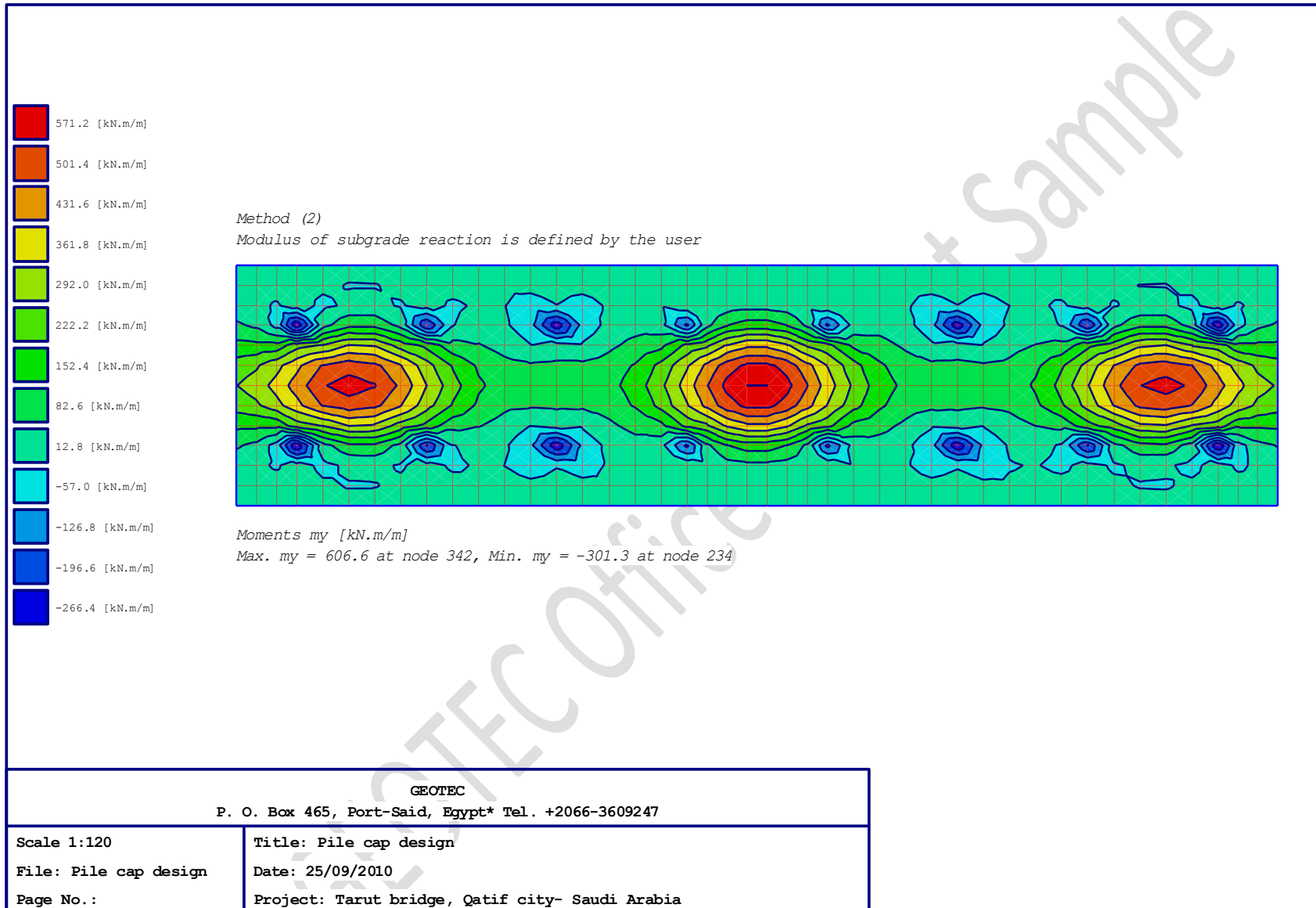

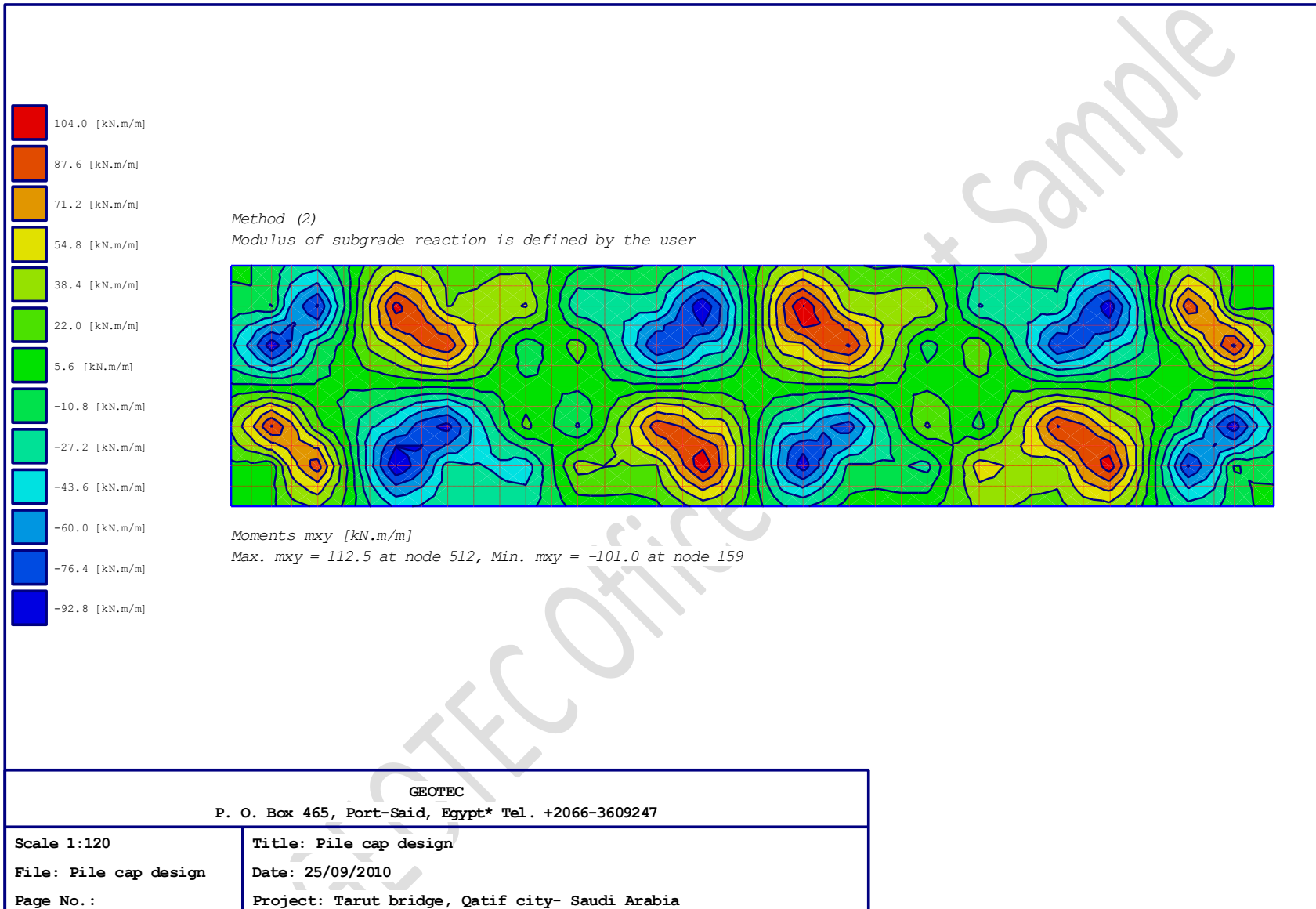

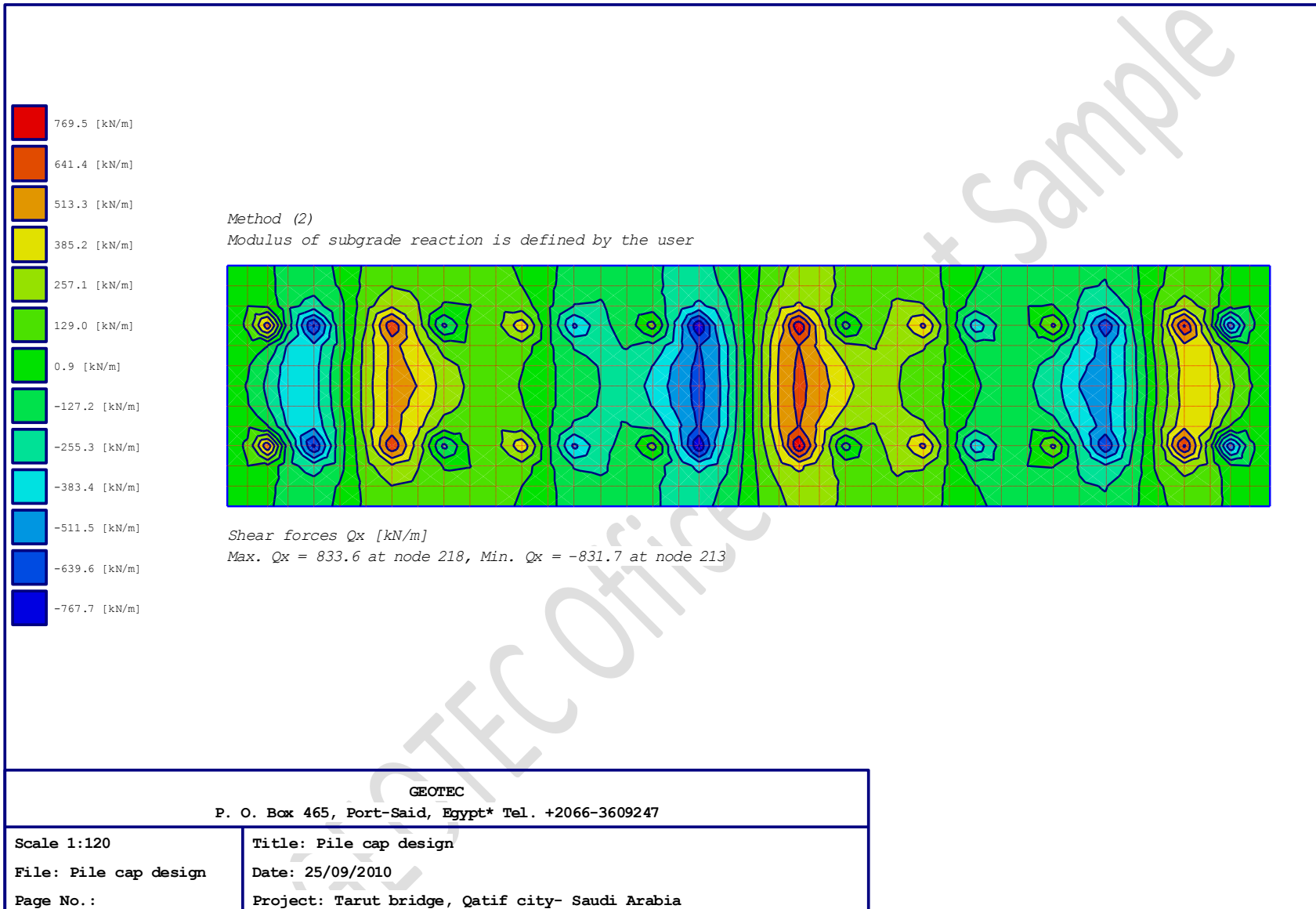

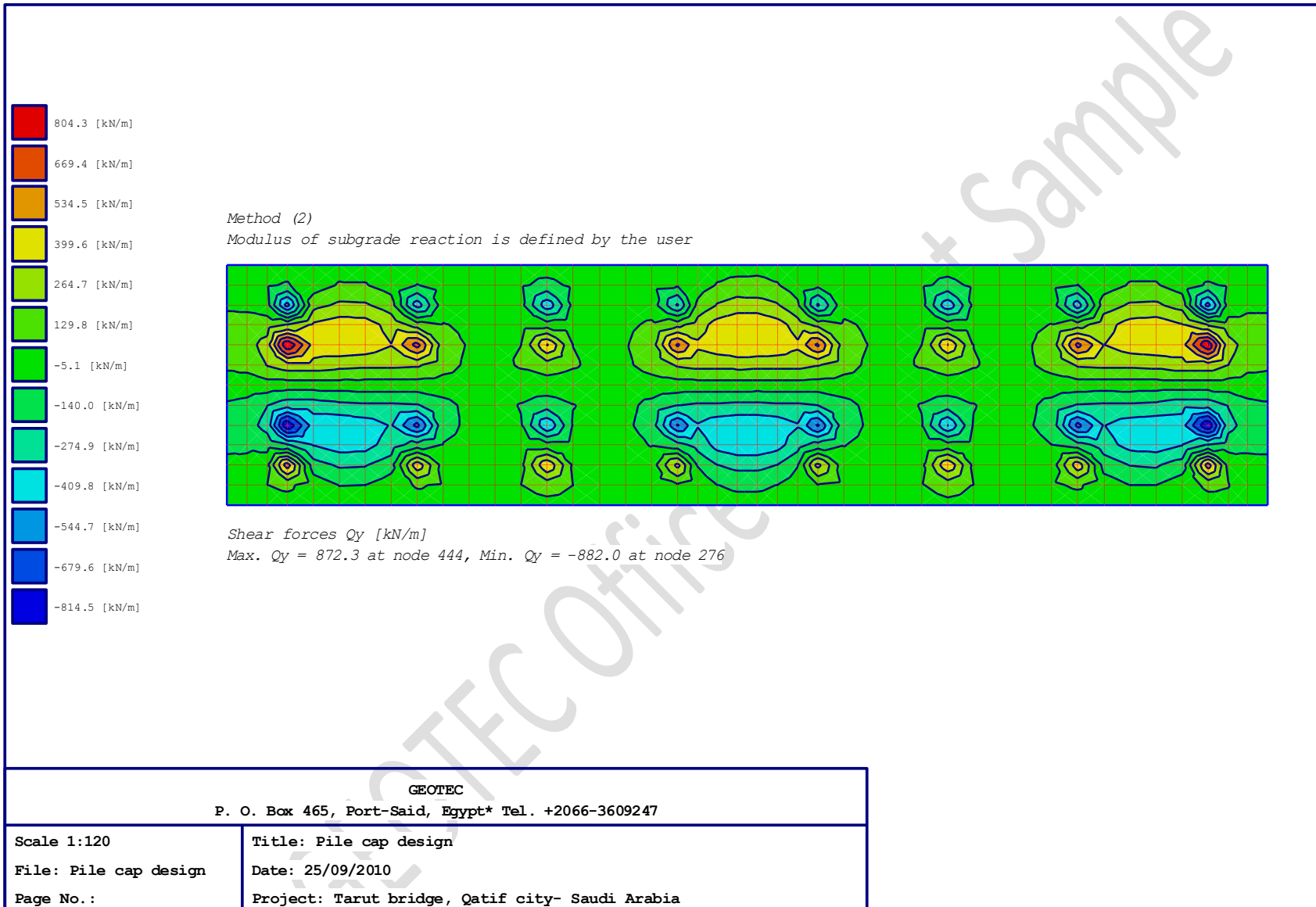

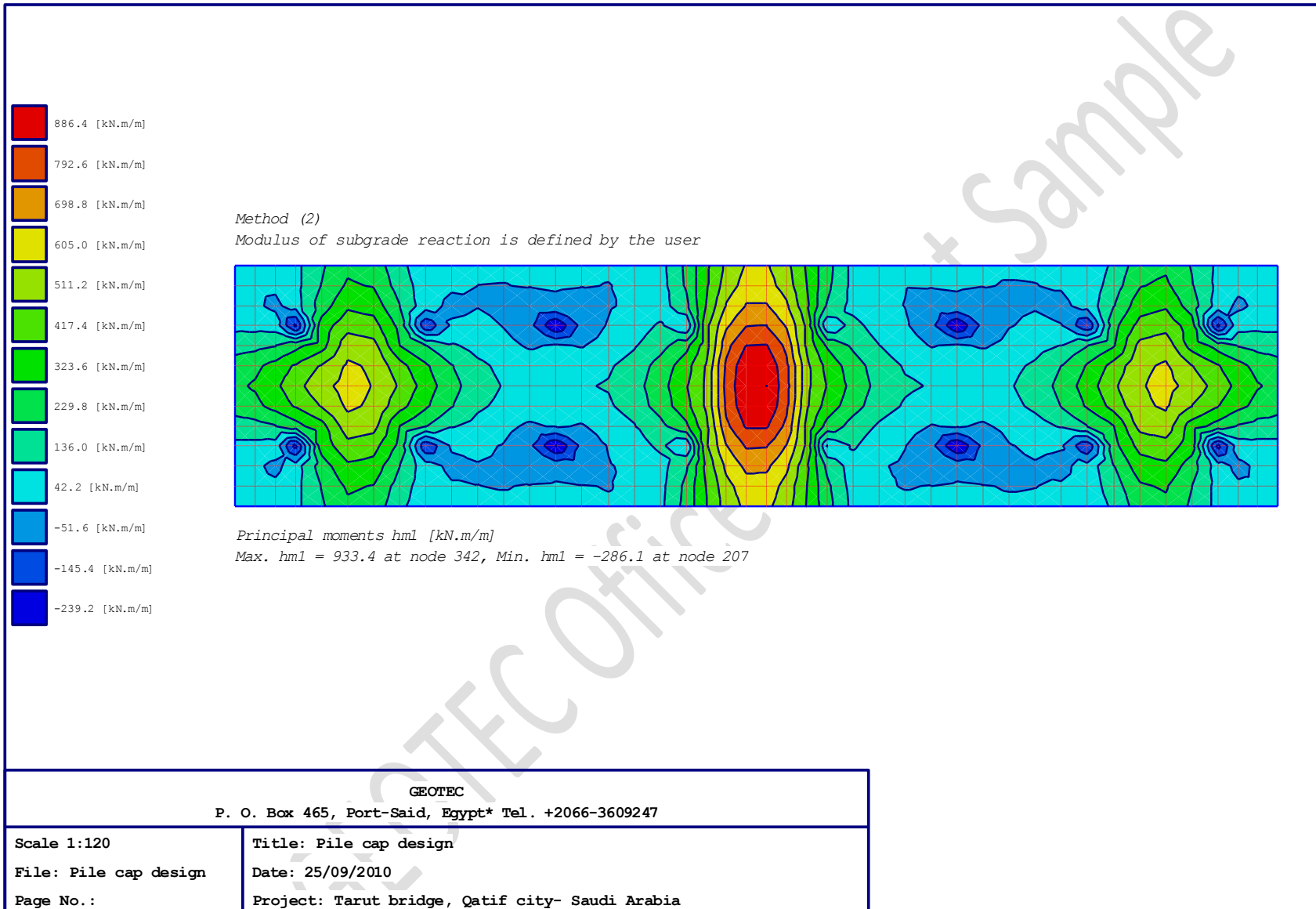

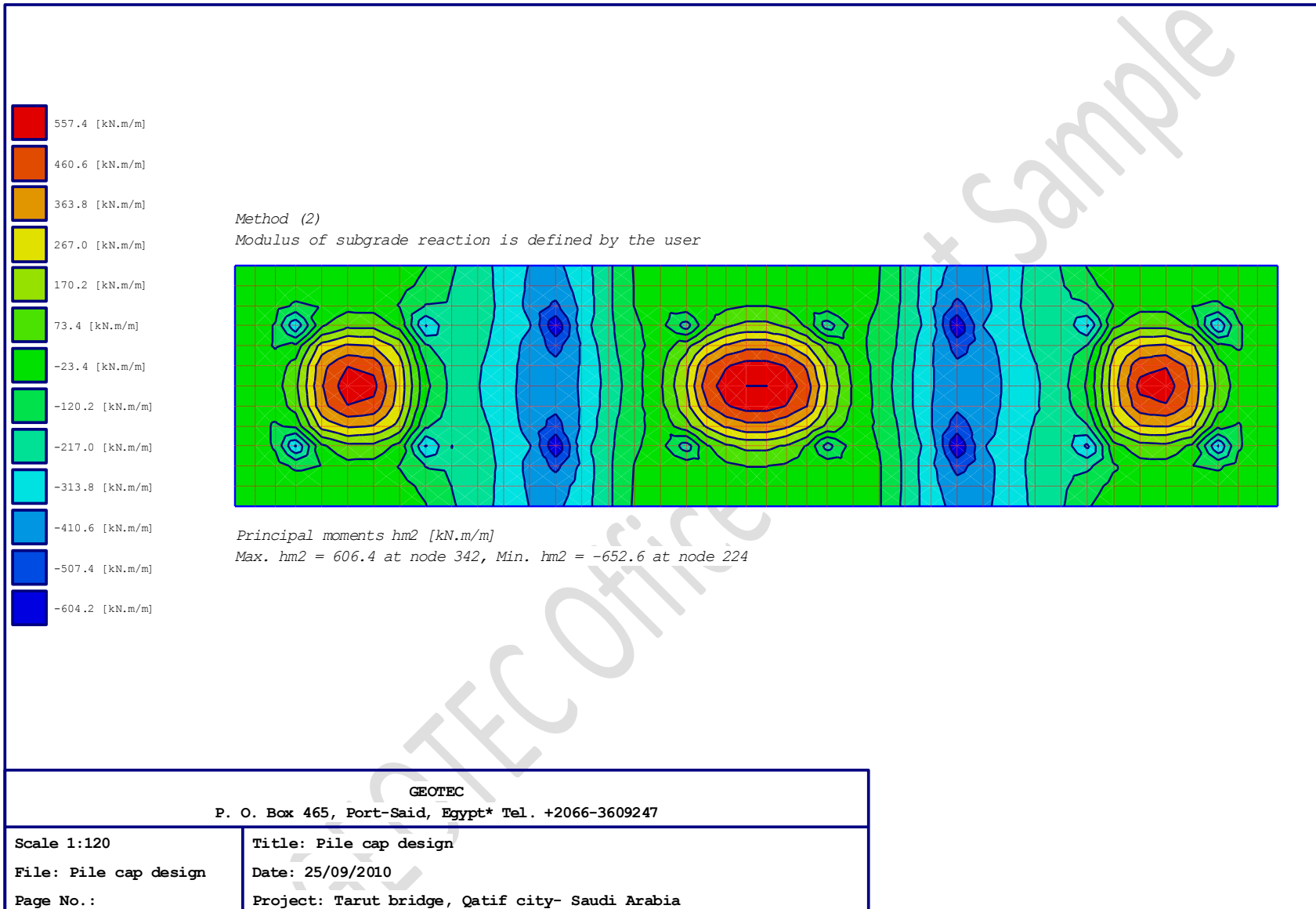

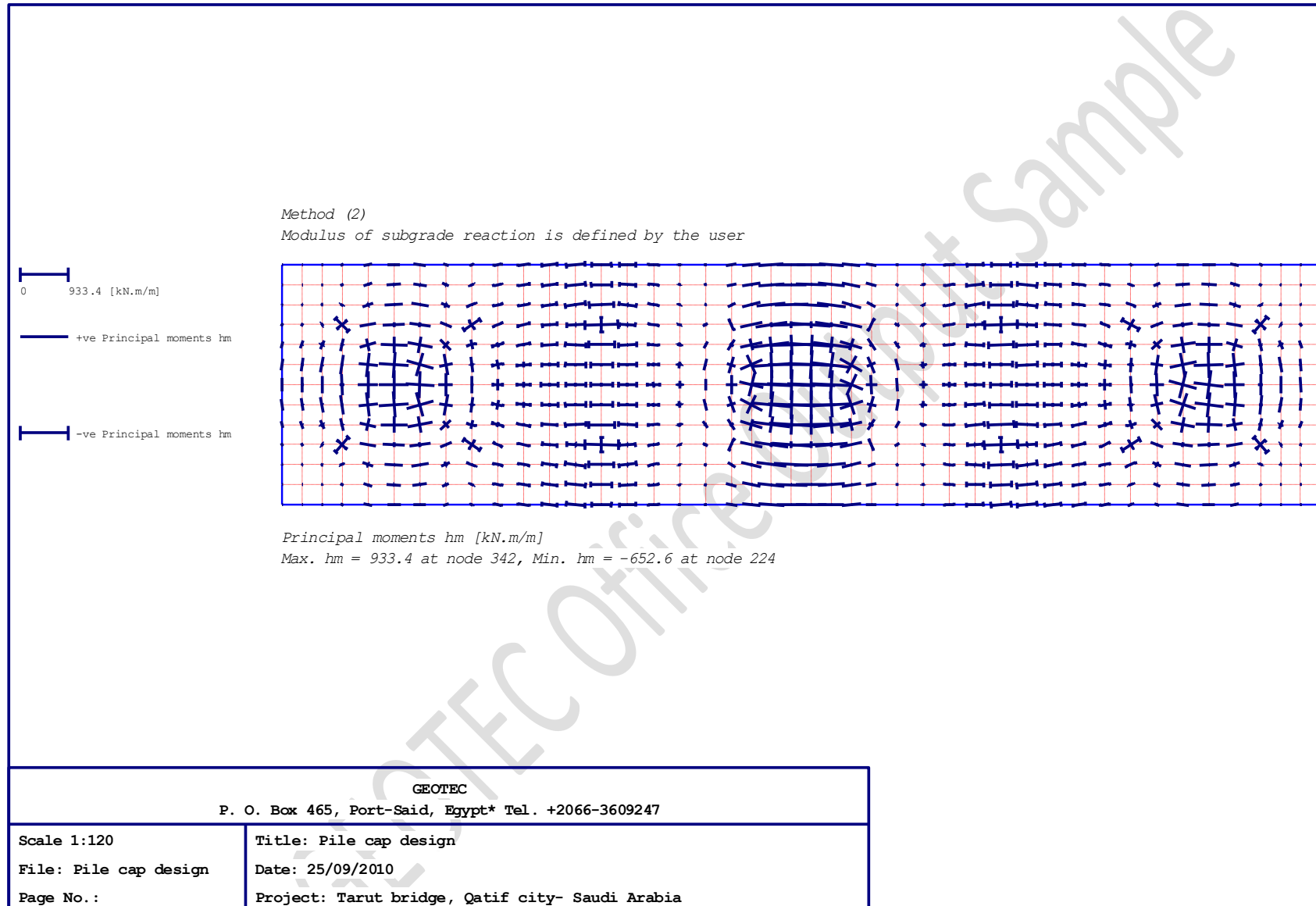

Method (2)
Modulus of subgrade reaction is defined by the user

1.73 [cm]
0

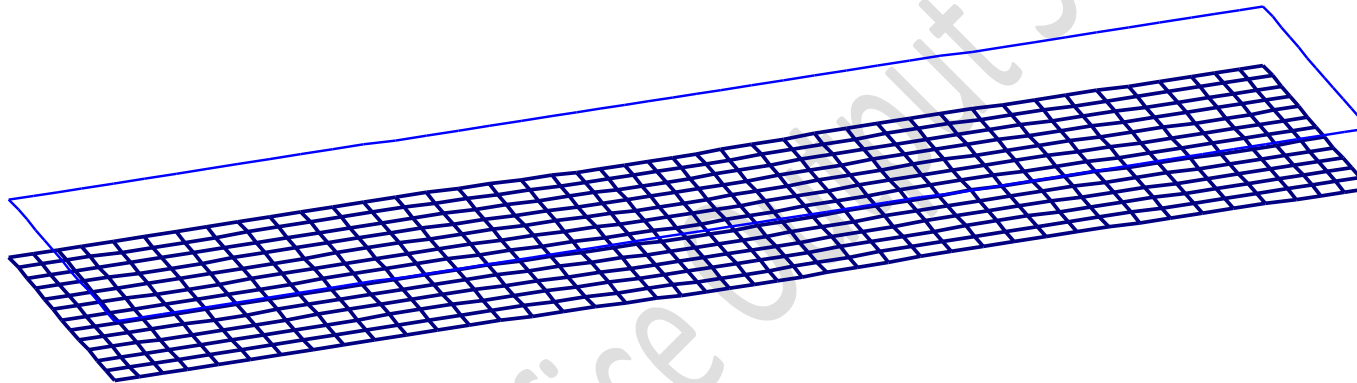

Slab deformation w [cm]
Max. $w = 1.73$ at node 299, Min. $w = 1.61$ at node 89

GEOTEC

P. O. Box 465, Port-Said, Egypt* Tel. +2066-3609247

Scale factor: 120

File: Pile cap design

Page No.:

Title: Pile cap design

Date: 25/09/2010

Project: Tarut bridge, Qatif city- Saudi Arabia

Method (2)
 Modulus of subgrade reaction is defined by the user

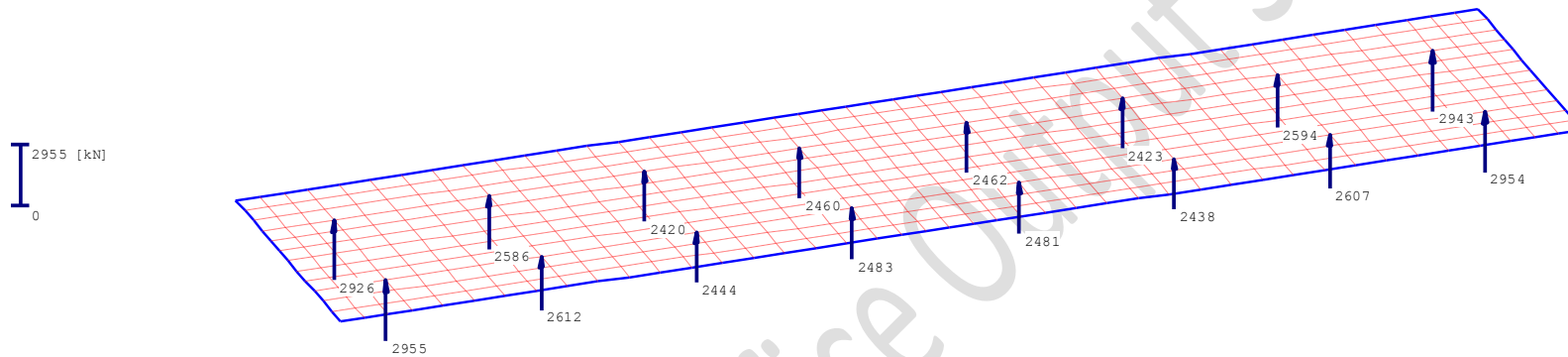

Support reactions V [kN]
 Max. V = 2955 at node 197, Min. V = 2420 at node 459, Sum = 41788

GEOTEC

P. O. Box 465, Port-Said, Egypt* Tel. +2066-3609247

Scale factor: 120

File: Pile cap design

Page No.:

Title: Pile cap design

Date: 25/09/2010

Project: Tarut bridge, Qatif city- Saudi Arabia

Method (2)
 Modulus of subgrade reaction is defined by the user

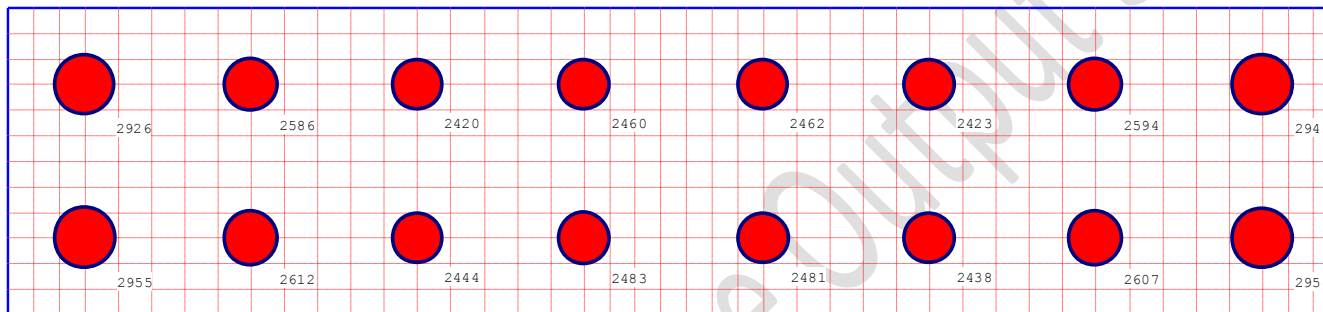

Support reactions V [kN]
 Max. $V = 2955$ at node 197, Min. $V = 2420$ at node 459, Sum = 41788

GEOTEC

P. O. Box 465, Port-Said, Egypt* Tel. +2066-3609247

Scale 1:120

File: Pile cap design

Page No.:

Title: Pile cap design

Date: 25/09/2010

Project: Tarut bridge, Qatif city- Saudi Arabia

Method (2)
 Modulus of subgrade reaction is defined by the user

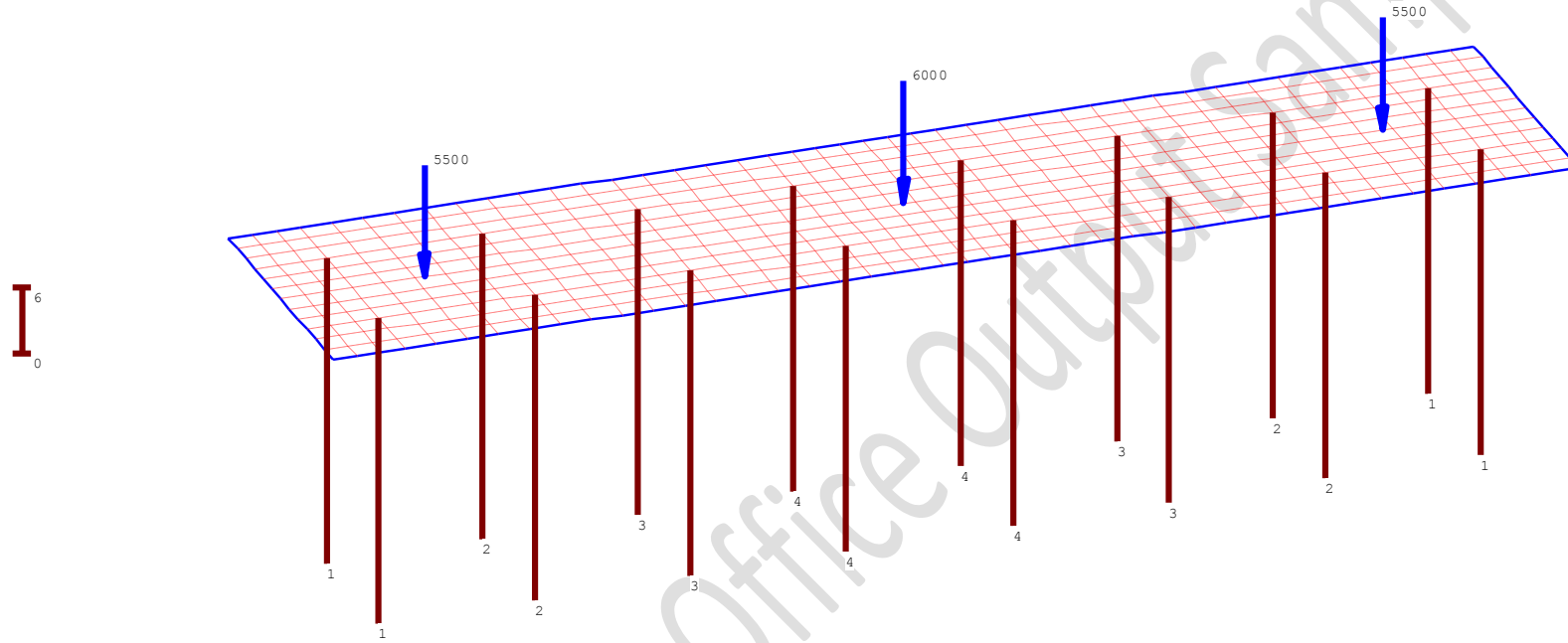

File locations and groups
 No. of pile groups = 4

GEO TEC

P. O. Box 465, Port-Said, Egypt* Tel. +2066-3609247

Scale factor: 120

File: Pile cap design

Page No.:

Title: Pile cap design

Date: 25/09/2010

Project: Tarut bridge, Qatif city- Saudi Arabia

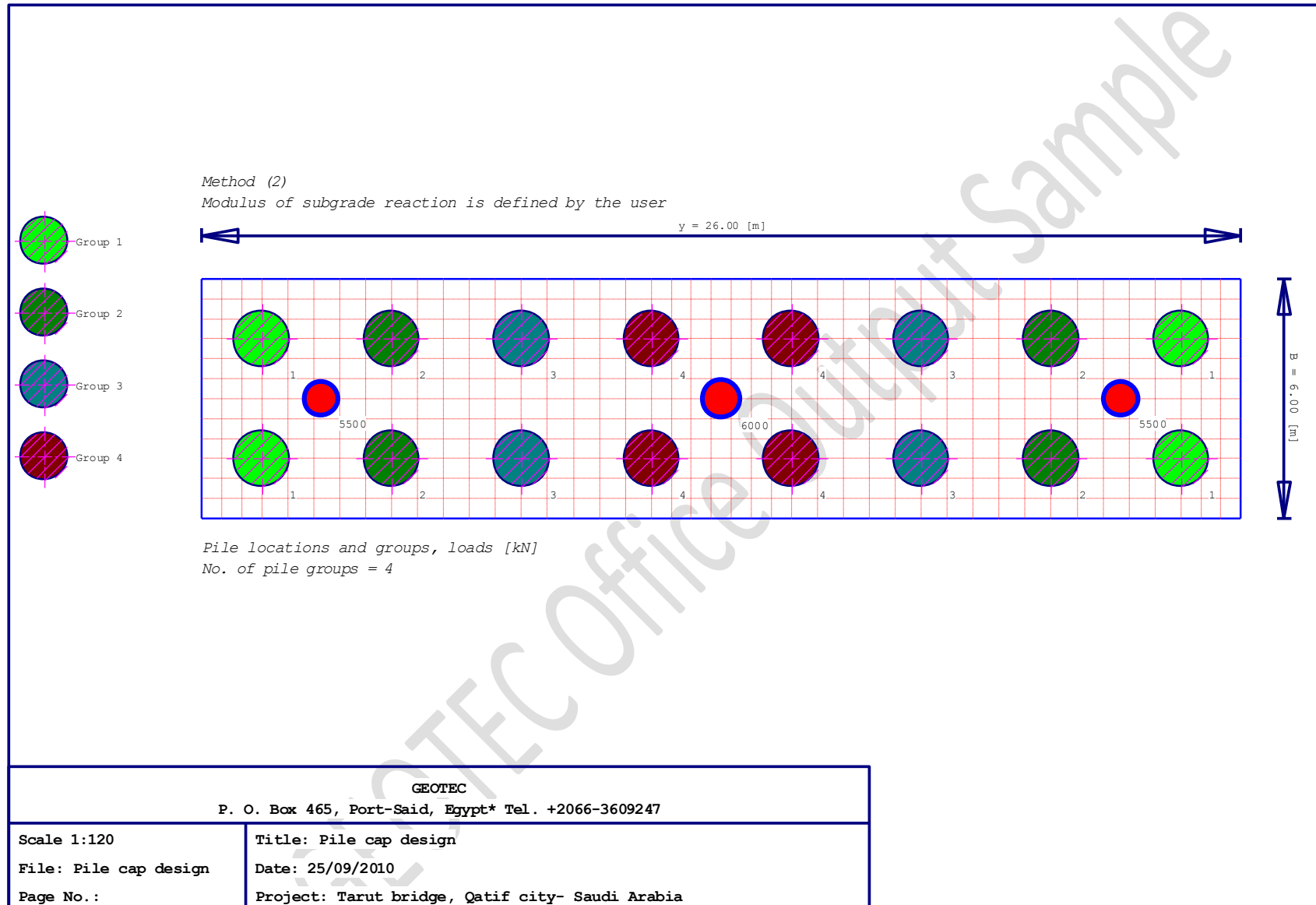

Method (2)
Modulus of subgrade reaction is defined by the user

1.25

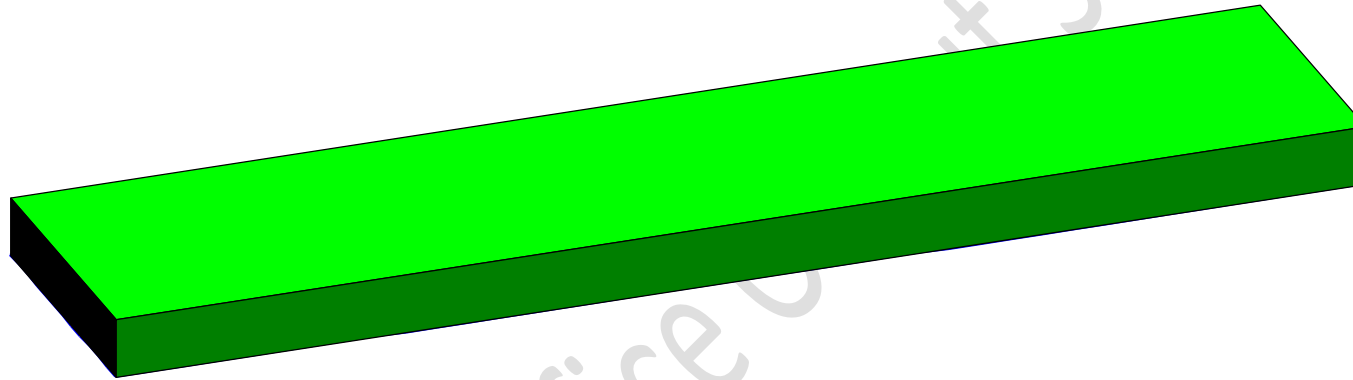

Slab thickness [m]
No. of element groups = 1

GEOTEC

P. O. Box 465, Port-Said, Egypt* Tel. +2066-3609247

Scale factor: 120

File: Pile cap design

Page No.:

Title: Pile cap design

Date: 25/09/2010

Project: Tarut bridge, Qatif city- Saudi Arabia

Method (2)
 Modulus of subgrade reaction is defined by the user

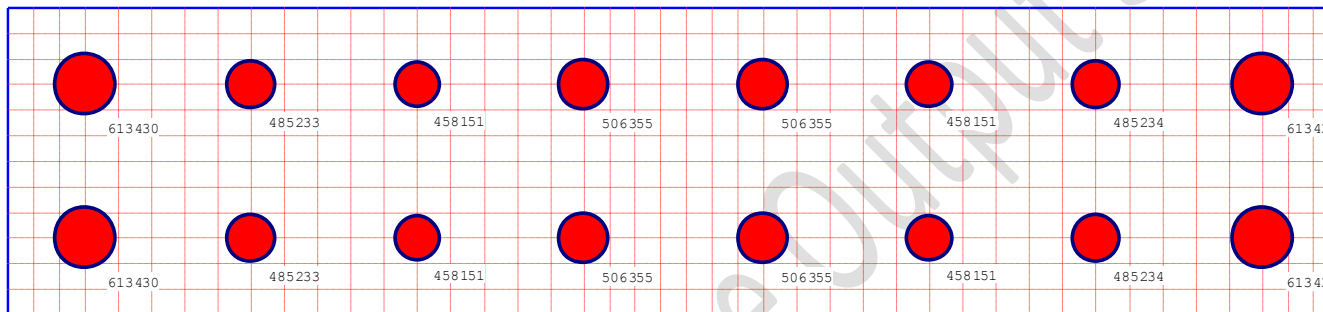

Modulus of subgrade reaction k_s [kN/m³]
 Max. k_s = 613430 at node 234, Min. k_s = 0 at node 1

GEOTEC

P. O. Box 465, Port-Said, Egypt* Tel. +2066-3609247

Scale 1:120

File: Pile cap design

Page No.:

Title: Pile cap design

Date: 25/09/2010

Project: Tarut bridge, Qatif city- Saudi Arabia

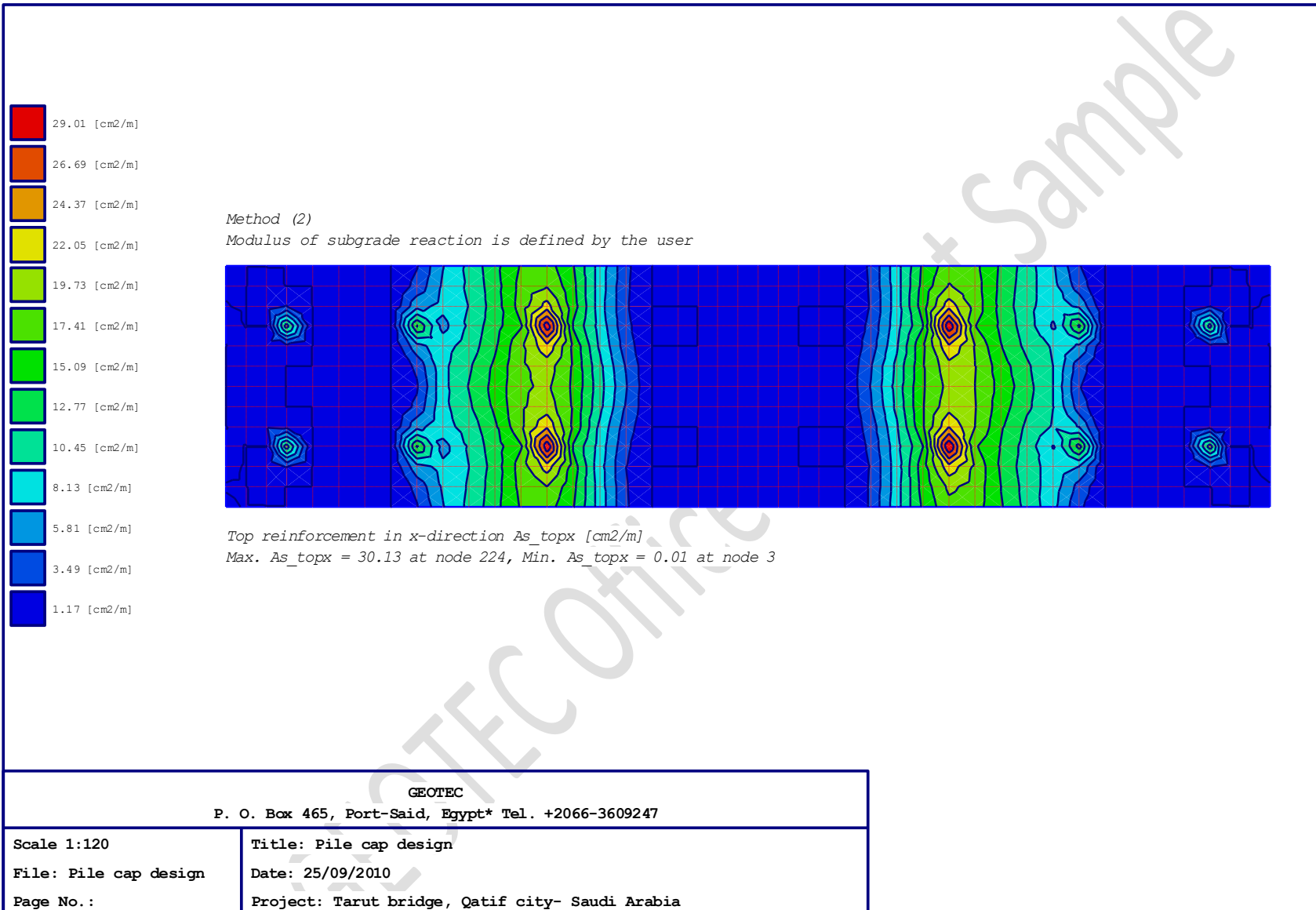

Method (2)
Modulus of subgrade reaction is defined by the user

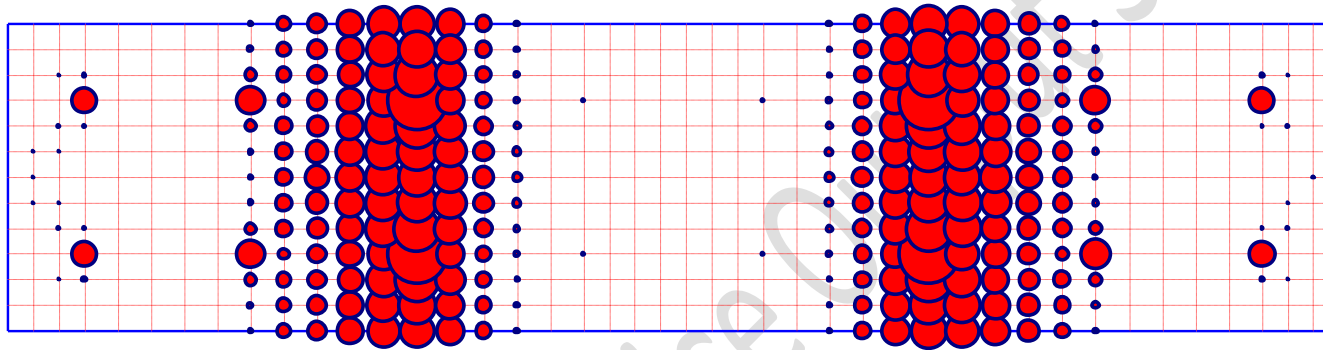

Top reinforcement in x-direction A_{s_topx} [cm²/m]
Max. A_{s_topx} = 30.13 at node 224, Min. A_{s_topx} = 0.01 at node 3

GEOTEC

P. O. Box 465, Port-Said, Egypt* Tel. +2066-3609247

Scale 1:120

File: Pile cap design

Page No.:

Title: Pile cap design

Date: 25/09/2010

Project: Tarut bridge, Qatif city- Saudi Arabia

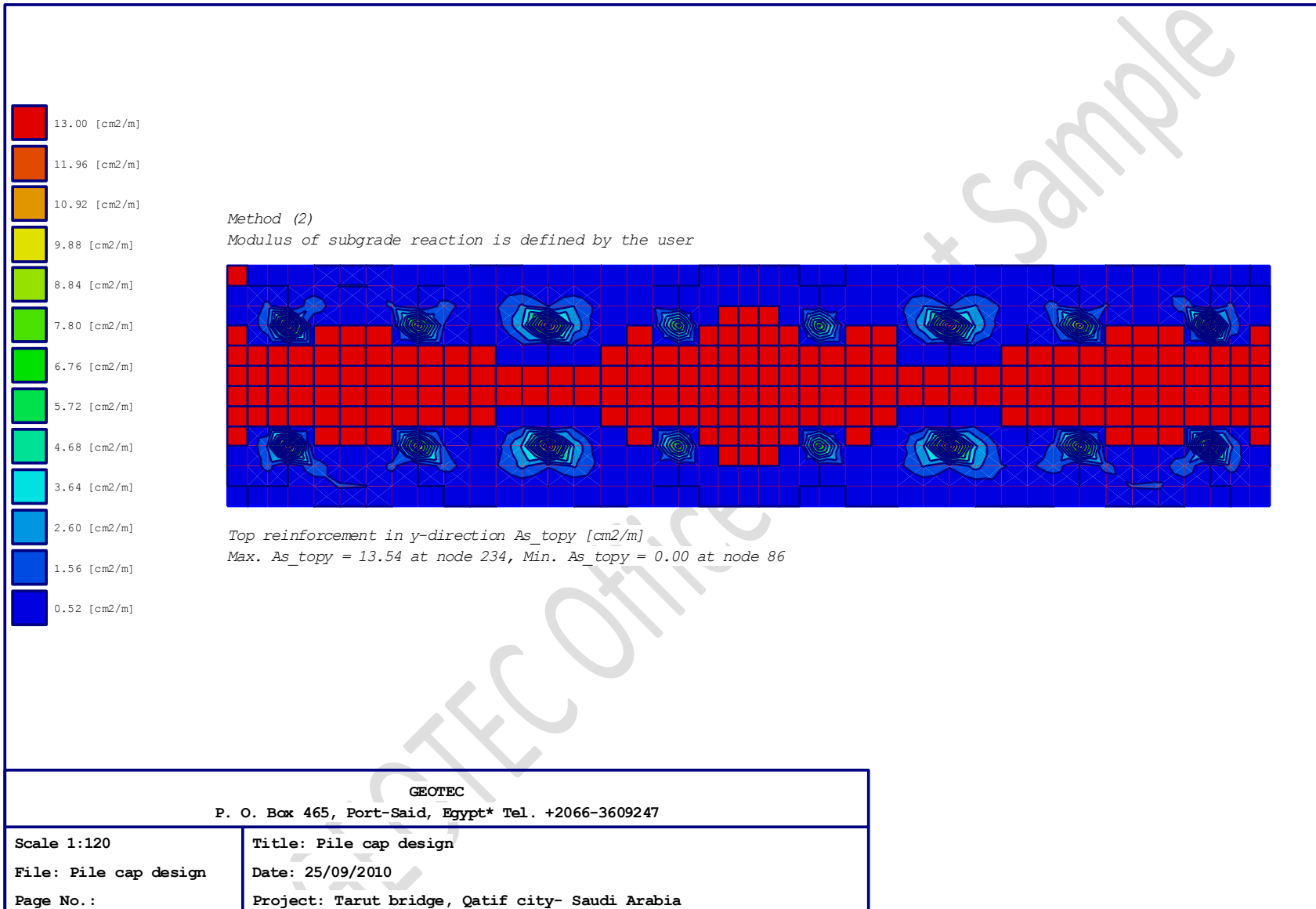

Method (2)
Modulus of subgrade reaction is defined by the user

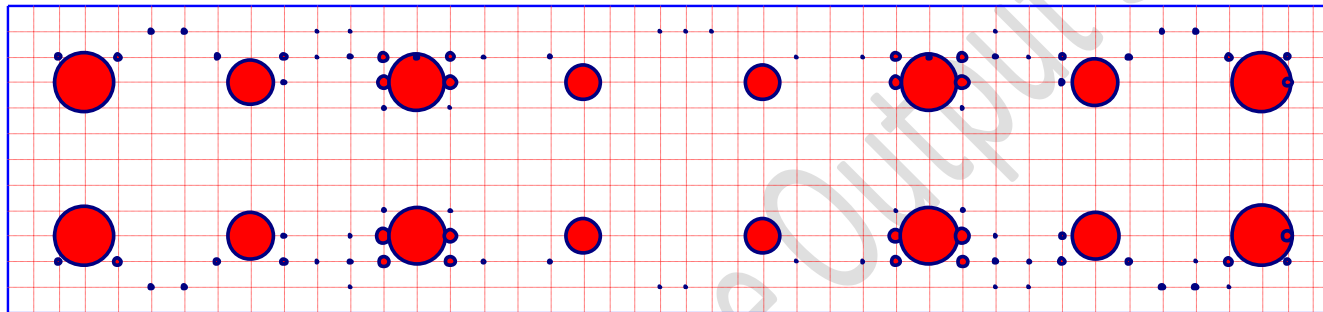

Top reinforcement in y-direction A_{s_topy} [cm²/m]
Max. A_{s_topy} = 13.54 at node 234, Min. A_{s_topy} = 0.00 at node 86

GEO TEC

P. O. Box 465, Port-Said, Egypt* Tel. +2066-3609247

Scale 1:120

File: Pile cap design

Page No.:

Title: Pile cap design

Date: 25/09/2010

Project: Tarut bridge, Qatif city- Saudi Arabia

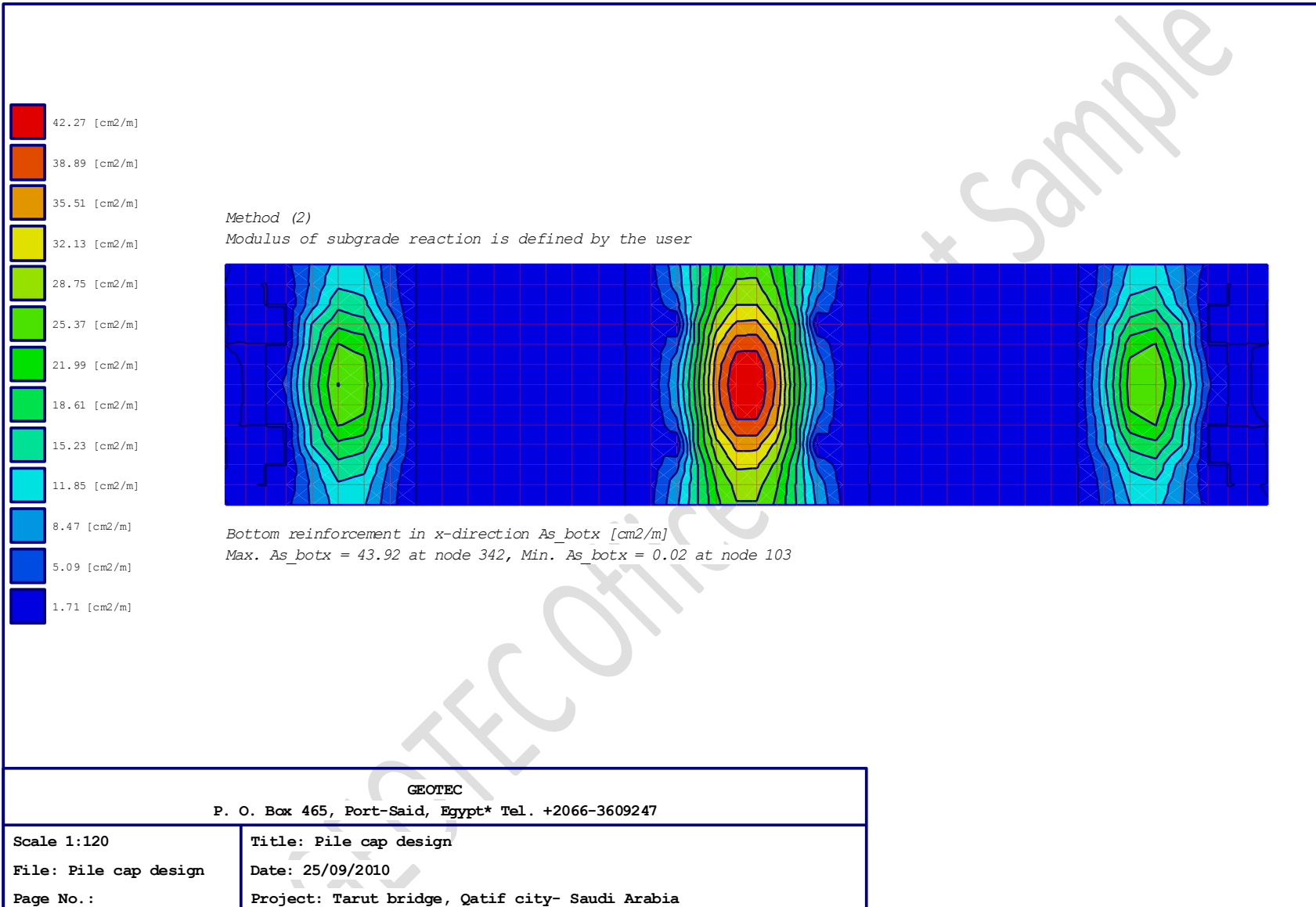

Method (2)
Modulus of subgrade reaction is defined by the user

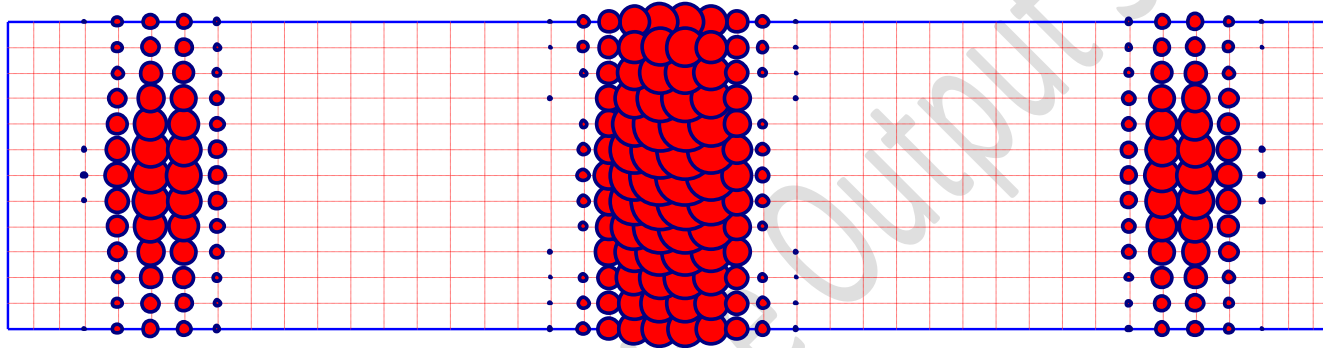

Bottom reinforcement in x-direction A_{s_botx} [cm²/m]
Max. A_{s_botx} = 43.92 at node 342, Min. A_{s_botx} = 0.02 at node 103

GEO TEC

P. O. Box 465, Port-Said, Egypt* Tel. +2066-3609247

Scale 1:120

File: Pile cap design

Page No.:

Title: Pile cap design

Date: 25/09/2010

Project: Tarut bridge, Qatif city- Saudi Arabia

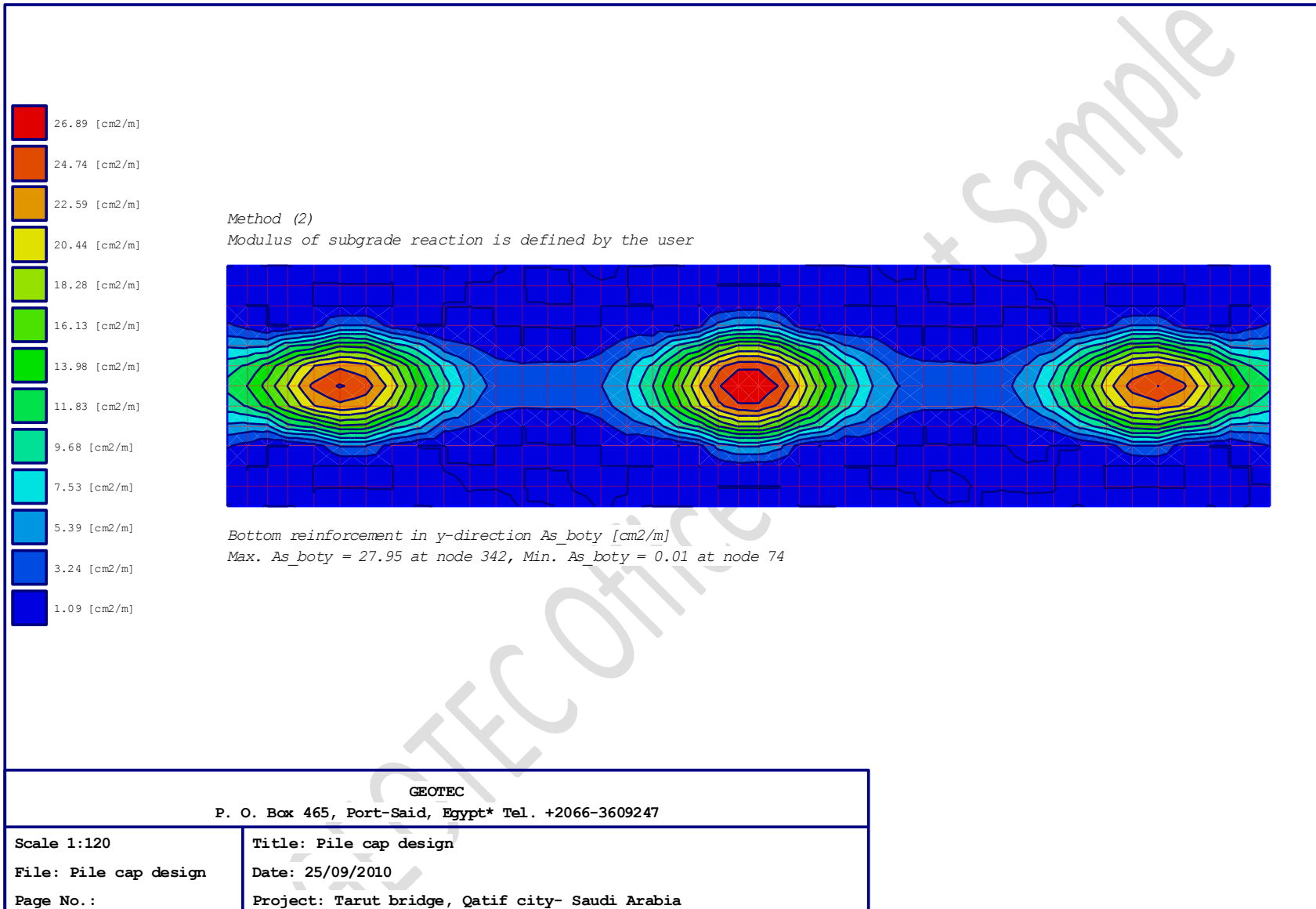

Method (2)
Modulus of subgrade reaction is defined by the user

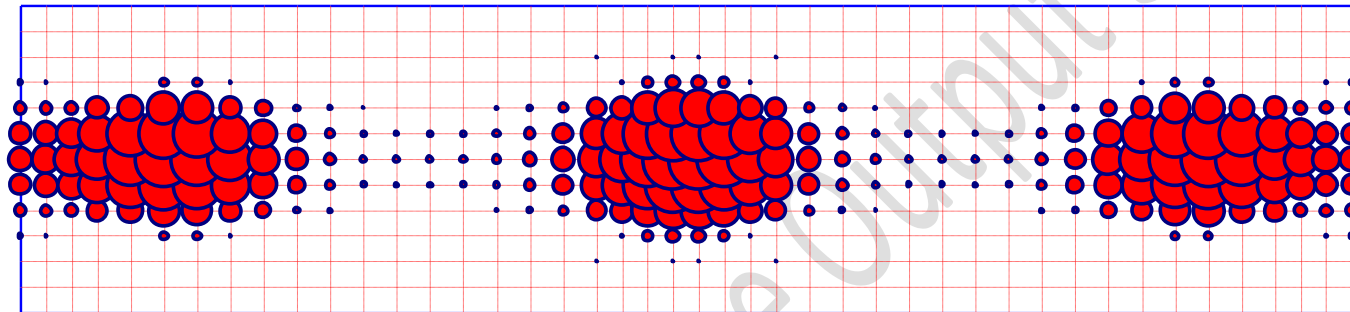

Bottom reinforcement in y-direction A_{s_boty} [cm²/m]
Max. A_{s_boty} = 27.95 at node 342, Min. A_{s_boty} = 0.01 at node 74

GEO TEC

P. O. Box 465, Port-Said, Egypt* Tel. +2066-3609247

Scale 1:120

File: Pile cap design

Page No.:

Title: Pile cap design

Date: 25/09/2010

Project: Tarut bridge, Qatif city- Saudi Arabia

5 Offshore - Check for uplift

This section has be omitted

6 Offshore - Seismic analysis

This section has be omitted

7 Onshore - Single pile analysis

```

*****
                          GeoTools
                          Version 2010
Program authors Prof. M. El Gendy/ Dr. A. El Gendy
*****
Title: Bearing capacity of single pile BH-1, D=1.0 [m]
Date: 25/09/2010
Project: Tarut bridge, Qatif city- Saudi Arabia
File: BH-1 - D 1.0 m
    
```

 Bearing capacity and settlement of a single pile
 according to ECP (1995)

Data:
 File diameter D [m] = 1.00
 File toe diameter Df [m] = 1.00
 File length Lg [m] = 28.00

Soil property

Layer	Layer Depth Under the SBL [m]	Soil Type	Av. SPT N Value	Bulk Unit Wt. [kN/m3]	Angle of Int. friction Φ [deg]	Undrainage cohesion Cu [kN/m2]	Modulus of Elasticity E [kN/m2]
1	0-2.5	SP/SP-SM	7	16	30	-	18500
2	2.5-5	CL	2	15	-	75	10000
3	5-20	SP-SM/SM	38	19	36	-	43000
4	20-35	CL	45	19.5	-	200	47000

Estimation of pile skin friction for non-cohesive soil

Layer	Soil Type	Layer Depth Under the SBL [m]	Angle of Int. friction Φ [deg]	Av. SPT N Value	Values according ECP (1995)		
					depth	SPT	Skin friction τ [kN/m2]
1	SP/SP-SM	0-2.5	30	7	-	<10	0
3	SP-SM/SM	5-20	36	38	>10	>30	100

Estimation of pile skin friction for cohesive soil

Layer	Soil Type	Layer Depth Under the SBL [m]	Undrainage cohesion Cu [kN/m2]	Av. SPT N Value	Values according ECP (1995)	
					Undrainage cohesion Cu [kN/m2]	Skin friction τ [kN/m2]
2	CL	2.5-5	75	2	75	35
4	CL	20-35	200	45	200	50

Tarut Bridge - Analysis and design of foundation

Summary of results

File tip resistance (Given)

s/Df = 0.02 Sig [kN/m²] = 500.000
 s/Df = 0.03 Sig1 [kN/m²] = 700.000
 s/Df = 0.10 SigGR [kN/m²] = 1200.000

Internal results

Skin friction:

Layer No.	Layer thickness	Penetration tip resistance	Undrainage cohesion of soil	Skin friction	Friction force
I	L1	qs	Cu	Tau	Qrg
[-]	[m]	[kN/m ²]	[kN/m ²]	[kN/m ²]	[kN]
1	2.50	-----	-----	0.000	0.0
2	2.50	-----	-----	35.000	274.9
3	15.00	-----	-----	100.000	4712.4
4	8.00	-----	-----	50.000	1256.6

Sum of friction forces Qrf [kN] = 6243.9

Load on pile head Qma+Qsp = Qv [kN] = 2250.0
 Skin friction part from Qv Qma [kN] = 2067.9
 End bearing part from Qv Qsp [kN] = 182.1
 Expected settlement sv [cm] = 0.99

File resistance depending on pile settlement:

No.	Referred settlement	File tip settlement	File friction resistance	Tip resistance	File resistance
I	s/Df	s	Qr	Qs	Q
[-]	[-]	[cm]	[kN]	[kN]	[kN]
1	0.02	2.00	4162.6	392.7	4555.3
2	0.03	3.00	6243.9	549.8	6793.7
3	0.03	3.00	6243.9	549.8	6793.7
4	0.10	10.00	6243.9	942.5	7186.4 = Qg=2*Qzul

Final results:

Allowable settlement Szul [cm] = 1.58
 Allowable pile load Qr+Qs = Qzul [kN] = 3593.2
 Skin friction part Qr [kN] = 3283.4
 End bearing part Qs [kN] = 309.8
 Safety factor Qzul/QV = ETHA [-] = 1.60

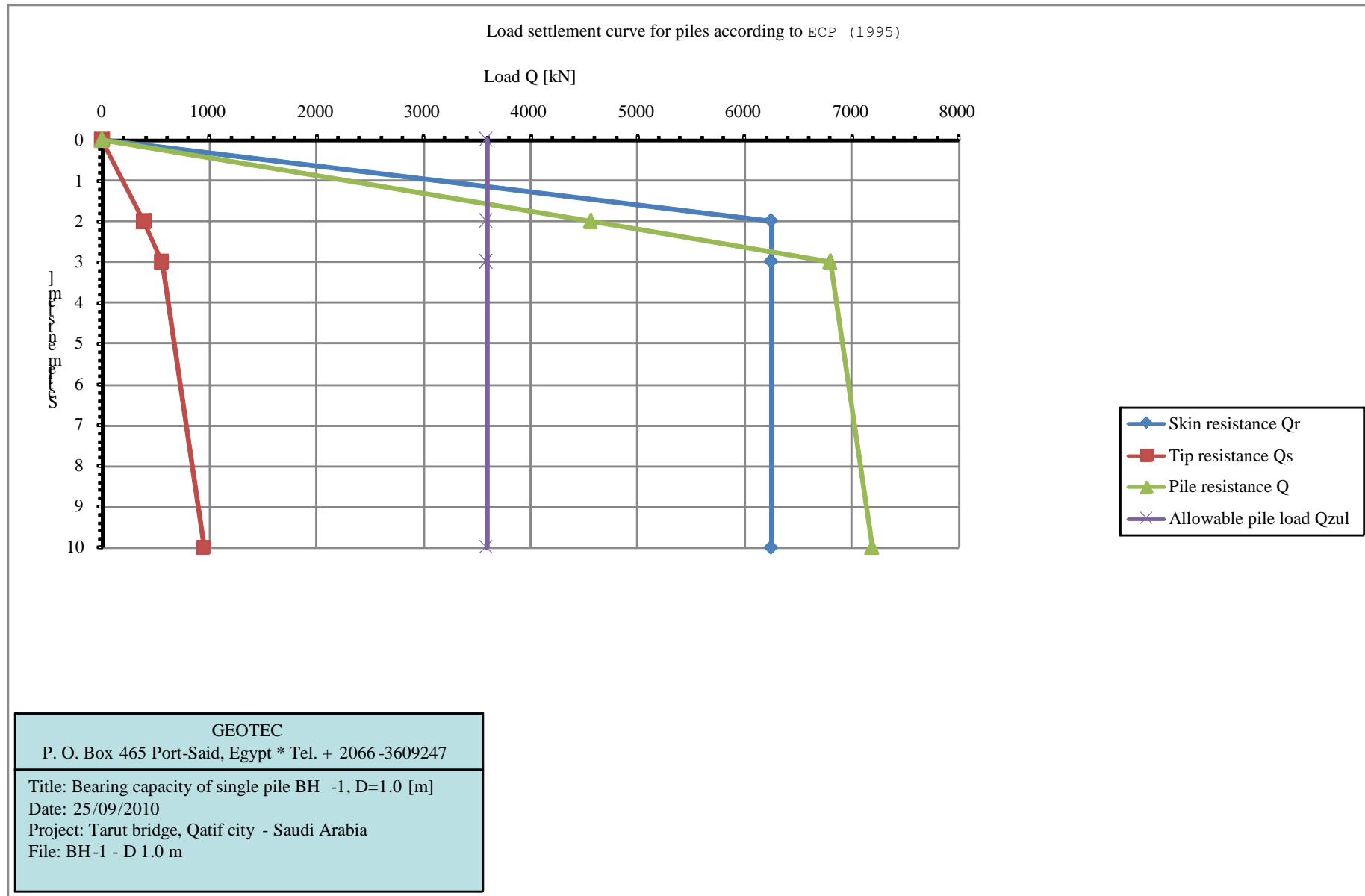

Tarut Bridge - Analysis and design of foundation

GeoTools
Version 2010

Program authors Prof. M. El Gendy/ Dr. A. El Gendy

Title: Bearing capacity of single pile BH-1, D=1.2 [m]

Date: 25/09/2010

Project: Tarut bridge, Qatif city- Saudi Arabia

File: BH-1 - D 1.2 m

Bearing capacity and settlement of a single pile
according to ECP (1995)

Data:

Pile diameter	D	[m]	=	1.20
Pile toe diameter	Df	[m]	=	1.20
Pile length	Lg	[m]	=	28.00

Soil property

Layer	Layer Depth Under the SBL [m]	Soil Type	Average SPT N Value	Bulk Unit Wt. [kN/m ³]	Angle of Int. friction Φ [deg]	Undrainage cohesion Cu [kN/m ²]	Modulus of Elasticity E [kN/m ²]
1	0-2.5	SP/SP-SM	7	16	30	-	18500
2	2.5-5	CL	2	15	-	75	10000
3	5-20	SP-SM/SM	38	19	36	-	43000
4	20-35	CL	45	19.5	-	200	47000

Estimation of pile skin friction for non-cohesive soil

Layer	Soil Type	Layer Depth Under the SBL [m]	Angle of Int. friction Φ [deg]	Av. SPT N Value	Values according ECP (1995)		
					depth	SPT	Skin friction τ [kN/m ²]
1	SP/SP-SM	0-2.5	30	7	-	<10	0
3	SP-SM/SM	5-20	36	38	>10	>30	100

Estimation of pile skin friction for cohesive soil

Layer	Soil Type	Layer Depth Under the SBL [m]	Undrainage cohesion Cu [kN/m ²]	Av. SPT N Value	Values according ECP (1995)	
					Undrainage cohesion Cu [kN/m ²]	Skin friction τ [kN/m ²]
2	CL	2.5-5	75	2	75	35
4	CL	20-35	200	45	200	50

Tarut Bridge - Analysis and design of foundation

Summary of results

File tip resistance (Given)

$s/D_f = 0.02$ Sig [kN/m²] = 500.000
 $s/D_f = 0.03$ Sig1 [kN/m²] = 700.000
 $s/D_f = 0.10$ SigGR [kN/m²] = 1200.000

Internal results

Skin friction:

Layer No.	Layer thickness [m]	Penetration tip resistance [kN/m ²]	Undrainage cohesion of soil [kN/m ²]	Skin friction [kN/m ²]	Friction force [kN]
I	L1	qs	Cu	Tau	Qrg
[-]	[m]	[kN/m ²]	[kN/m ²]	[kN/m ²]	[kN]
1	2.50	-----	-----	0.000	0.0
2	2.50	-----	-----	35.000	329.9
3	15.00	-----	-----	100.000	5654.9
4	8.00	-----	-----	50.000	1508.0

Sum of friction forces Qrf [kN] = 7492.7

Load on pile head Q_{ma}+Q_{sp} = Q_v [kN] = 2700.0
 Skin friction part from Q_v Q_{ma} [kN] = 2475.8
 End bearing part from Q_v Q_{sp} [kN] = 224.2
 Expected settlement sv [cm] = 0.99

Pile resistance depending on pile settlement:

No.	Referred settlement	Pile tip settlement	Pile friction resistance	Tip resistance	Pile resistance
I	s/D _f	s	Q _r	Q _s	Q
[-]	[-]	[cm]	[kN]	[kN]	[kN]
1	0.02	2.40	5994.2	565.5	6559.6
2	0.03	3.00	7492.7	678.6	8171.3
3	0.03	3.60	7492.7	791.7	8284.4
4	0.10	12.00	7492.7	1357.2	8849.9 = Q _g =2*Q _{zul}

Final results:

Allowable settlement Szul [cm] = 1.62
 Allowable pile load Q_r+Q_s = Q_{zul} [kN] = 4424.9
 Skin friction part Q_r [kN] = 4043.5
 End bearing part Q_s [kN] = 381.5
 Safety factor Q_{zul}/Q_v = ETHA [-] = 1.64

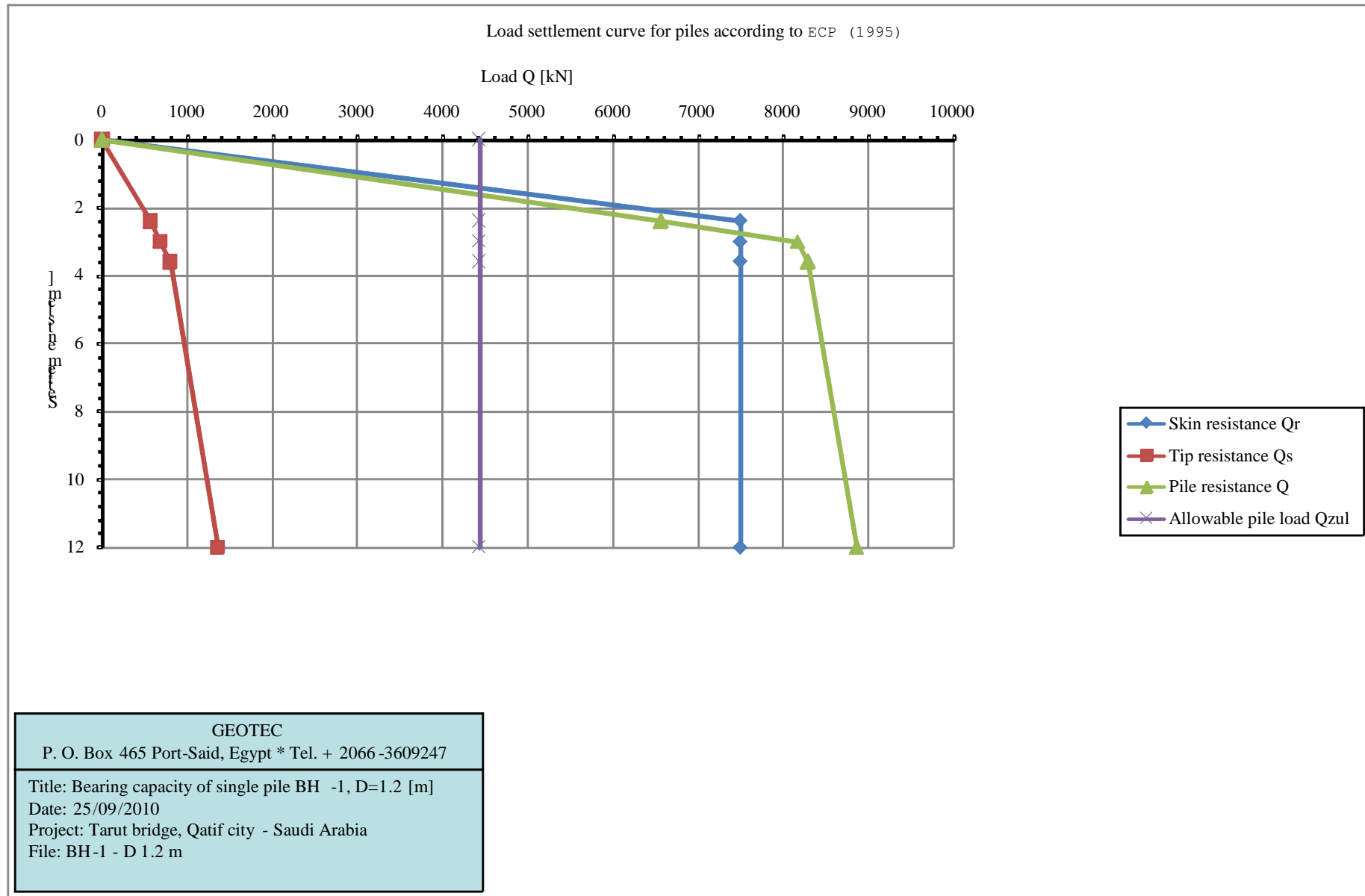

Tarut Bridge - Analysis and design of foundation

GeoTools
Version 2010

Program authors Prof. M. El Gendy/ Dr. A. El Gendy

Title: Bearing capacity of single pile BH-1, D=1.4 [m]

Date: 25/09/2010

Project: Tarut bridge, Qatif city- Saudi Arabia

File: BH-1 - D 1.4 m

Bearing capacity and settlement of a single pile
according to ECP (1995)

Data:

Pile diameter	D	[m]	=	1.40
Pile toe diameter	Df	[m]	=	1.40
Pile length	Lg	[m]	=	28.00

Soil property

Layer	Layer Depth Under the SBL [m]	Soil Type	Average SPT N Value	Bulk Unit Wt. [kN/m ³]	Angle of Int. friction Φ [deg]	Undrainage cohesion Cu [kN/m ²]	Modulus of Elasticity E [kN/m ²]
1	0-2.5	SP/SP-SM	7	16	30	-	18500
2	2.5-5	CL	2	15	-	75	10000
3	5-20	SP-SM/SM	38	19	36	-	43000
4	20-35	CL	45	19.5	-	200	47000

Estimation of pile skin friction for non-cohesive soil

Layer	Soil Type	Layer Depth Under the SBL [m]	Angle of Int. friction Φ [deg]	Av. SPT N Value	Values according ECP (1995)		
					depth	SPT	Skin friction τ [kN/m ²]
1	SP/SP-SM	0-2.5	30	7	-	<10	0
3	SP-SM/SM	5-20	36	38	>10	>30	100

Estimation of pile skin friction for cohesive soil

Layer	Soil Type	Layer Depth Under the SBL [m]	Undrainage cohesion Cu [kN/m ²]	Av. SPT N Value	Values according ECP (1995)	
					Undrainage cohesion Cu [kN/m ²]	Skin friction τ [kN/m ²]
2	CL	2.5-5	75	2	75	35
4	CL	20-35	200	45	200	50

Tarut Bridge - Analysis and design of foundation

Summary of results

File tip resistance (Given)

s/Df = 0.02	Sig	[kN/m2] = 500.000
s/Df = 0.03	Sig1	[kN/m2] = 700.000
s/Df = 0.10	SigGR	[kN/m2] = 1200.000

Internal results

Skin friction:

Layer No.	Layer thickness	Penetration tip resistance	Undrainage cohesion of soil	Skin friction	Friction force
I	L1	qs	Cu	Tau	Qrg
[-]	[m]	[kN/m2]	[kN/m2]	[kN/m2]	[kN]
1	2.50	-----	-----	0.000	0.0
2	2.50	-----	-----	35.000	384.8
3	15.00	-----	-----	100.000	6597.3
4	8.00	-----	-----	50.000	1759.3

Sum of friction forces Qrf [kN] = 8741.5

Load on pile head Qma+Qsp = Qv [kN] = 3200.0
 Skin friction part from Qv Qma [kN] = 2927.5
 End bearing part from Qv Qsp [kN] = 272.5
 Expected settlement sv [cm] = 1.00

Pile resistance depending on pile settlement:

No.	Referred settlement	Pile tip settlement	Pile friction resistance	Tip resistance	Pile resistance
I	s/Df	s	Qr	Qs	Q
[-]	[-]	[cm]	[kN]	[kN]	[kN]
1	0.02	2.80	8158.7	769.7	8928.4
2	0.02	3.00	8741.5	813.7	9555.2
3	0.03	4.20	8741.5	1077.6	9819.0
4	0.10	14.00	8741.5	1847.3	10588.7 = Qg=2*Qzul

Final results:

Allowable settlement Szul [cm] = 1.66
 Allowable pile load Qr+Qs = Qzul [kN] = 5294.4
 Skin friction part Qr [kN] = 4838.0
 End bearing part Qs [kN] = 456.4
 Safety factor Qzul/QV = ETHA [-] = 1.65

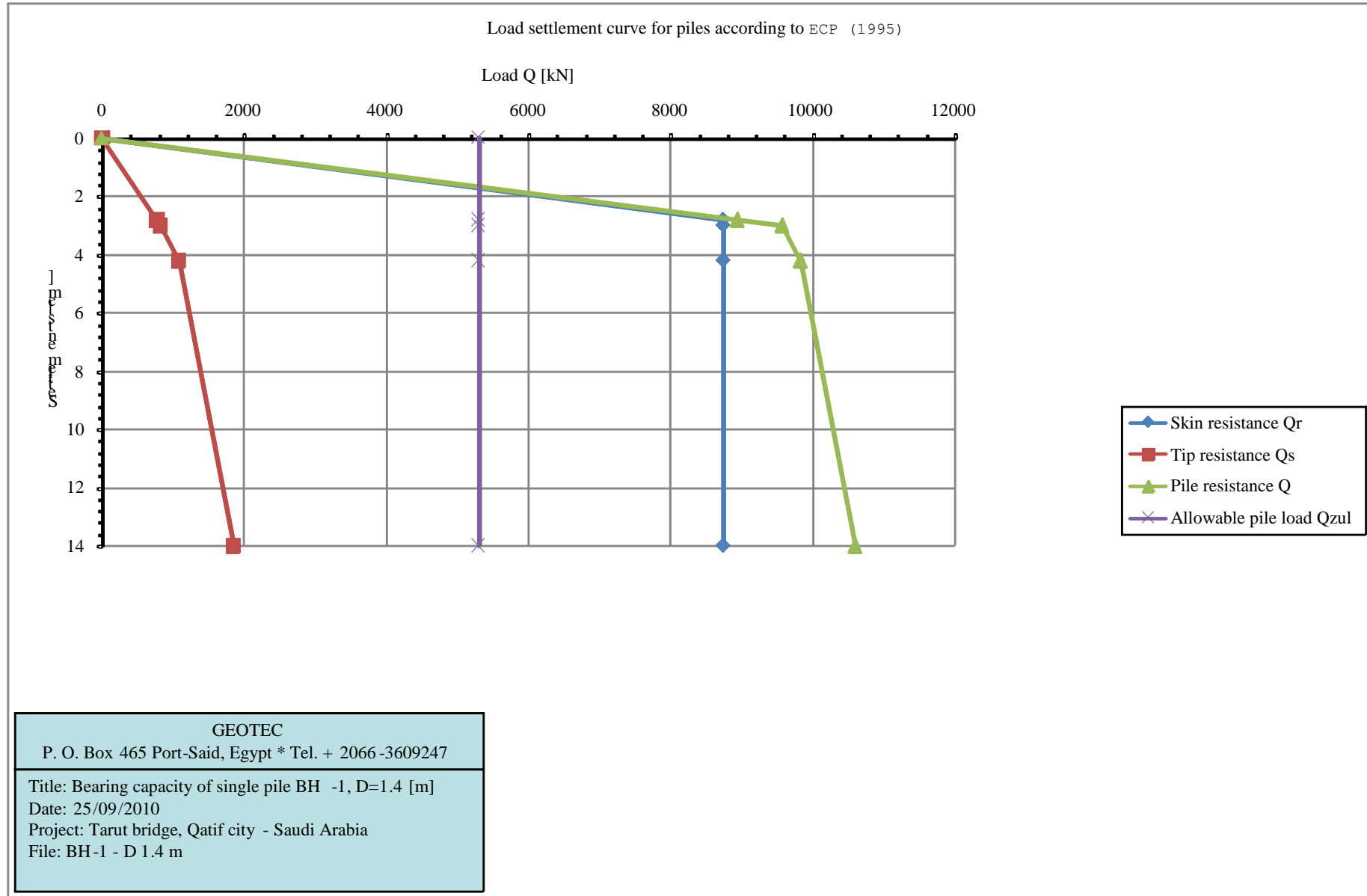

Tarut Bridge - Analysis and design of foundation

GeoTools
Version 2010

Program authors Prof. M. El Gendy/ Dr. A. El Gendy

Title: Bearing capacity of single pile BH-4, D=1.0 [m]

Date: 25/09/2010

Project: Tarut bridge, Qatif city- Saudi Arabia

File: BH-4 - D 1.0 m

Bearing capacity and settlement of a single pile
according to ECP (1995)

Data:

Pile diameter D [m] = 1.00
Pile toe diameter Df [m] = 1.00
Pile length Lg [m] = 28.00

Soil property

Layer	Layer Depth Under the SBL [m]	Soil Type	Av. SPT N Value	Bulk Unit Wt. [kN/m3]	Angle of Int. friction Φ [deg]	Undrainage cohesion Cu [kN/m2]	Modulus of Elasticity E [kN/m2]
1	0-5.5	SP/SP-SM	7	16	30	-	18500
2	5.5-10	CL	2	15	-	75	10000
3	10-28	SP-SM/SM	38	19	36	-	43000

Estimation of pile skin friction for non-cohesive soil

Layer	Soil Type	Layer Depth Under the SBL [m]	Angle of Int. friction Φ [deg]	Av. SPT N Value	Values according ECP (1995)		
					depth	SPT	Skin friction τ [kN/m2]
1	SP/SP-SM	0-5.5	30	7	-	<10	0
3	SP-SM/SM	10-28	36	38	>10	>30	100

Estimation of pile skin friction for cohesive soil

Layer	Soil Type	Layer Depth Under the SBL [m]	Undrainage cohesion Cu [kN/m2]	Av. SPT N Value	Values according ECP (1995)	
					Undrainage cohesion Cu [kN/m2]	Skin friction τ [kN/m2]
2	CL	5.5-10	75	2	75	35

Tarut Bridge - Analysis and design of foundation

Summary of results

File tip resistance (Given)

s/Df = 0.02 Sig [kN/m²] = 800.000
s/Df = 0.03 Sig1 [kN/m²] = 1100.000
s/Df = 0.10 SigGR [kN/m²] = 2442.000

Internal results

Skin friction:

Layer No.	Layer thickness	Penetration tip resistance	Undrainage cohesion of soil	Skin friction	Friction force
I [-]	L1 [m]	qs [kN/m ²]	Cu [kN/m ²]	Tau [kN/m ²]	Qrg [kN]
1	5.50	-----	-----	0.000	0.0
2	4.50	-----	-----	35.000	494.8
3	18.00	-----	-----	100.000	5654.9

Sum of friction forces Qrf [kN] = 6149.7

Load on pile head Qma+Qsp = Qv [kN] = 2350.0
Skin friction part from Qv Qma [kN] = 2060.5
End bearing part from Qv Qsp [kN] = 289.5
Expected settlement sv [cm] = 0.99

File resistance depending on pile settlement:

No.	Referred settlement	File tip settlement	File friction resistance	Tip resistance	File resistance
I [-]	s/Df [-]	s [cm]	Qr [kN]	Qs [kN]	Q [kN]
1	0.02	2.00	4099.8	628.3	4728.1
2	0.03	3.00	6149.7	863.9	7013.6
3	0.03	3.00	6149.7	863.9	7013.6
4	0.10	10.00	6149.7	1917.9	8067.6 = Qg=2*Qzul

Final results:

Allowable settlement Szul [cm] = 1.71
Allowable pile load Qr+Qs = Qzul [kN] = 4033.8
Skin friction part Qr [kN] = 3497.8
End bearing part Qs [kN] = 536.1
Safety factor Qzul/QV = ETHA [-] = 1.72

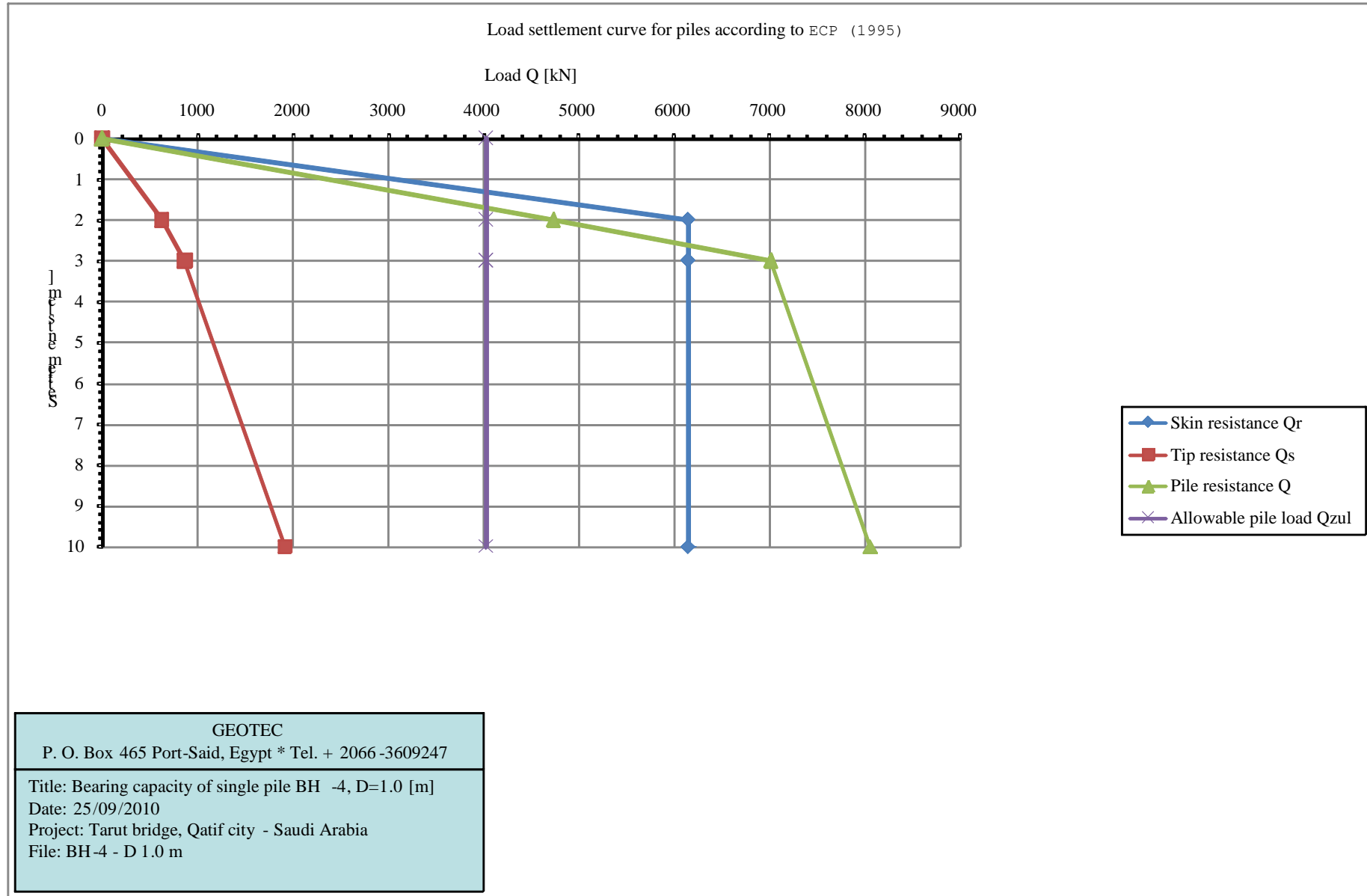

Tarut Bridge - Analysis and design of foundation

GeoTools
Version 2010

Program authors Prof. M. El Gendy/ Dr. A. El Gendy

Title: Bearing capacity of single pile BH-4, D=1.2 [m]

Date: 25/09/2010

Project: Tarut bridge, Qatif city- Saudi Arabia

File: BH-4 - D 1.2 m

Bearing capacity and settlement of a single pile
according to ECP (1995)

Data:

Pile diameter	D	[m]	=	1.20
Pile toe diameter	Df	[m]	=	1.20
Pile length	Lg	[m]	=	26.00

Soil property

Layer	Layer Depth Under the SBL [m]	Soil Type	Av. SPT N Value	Bulk Unit Wt. [kN/m3]	Angle of Int. friction Φ [deg]	Undrainage cohesion Cu [kN/m2]	Modulus of Elasticity E [kN/m2]
1	0-5.5	SP/SP-SM	7	16	30	-	18500
2	5.5-10	CL	2	15	-	75	10000
3	10-28	SP-SM/SM	38	19	36	-	43000

Estimation of pile skin friction for non-cohesive soil

Layer	Soil Type	Layer Depth Under the SBL [m]	Angle of Int. friction Φ [deg]	Av. SPT N Value	Values according ECP (1995)		
					depth	SPT	Skin friction τ [kN/m2]
1	SP/SP-SM	0-5.5	30	7	-	<10	0
3	SP-SM/SM	10-28	36	38	>10	>30	100

Estimation of pile skin friction for cohesive soil

Layer	Soil Type	Layer Depth Under the SBL [m]	Undrainage cohesion Cu [kN/m2]	Av. SPT N Value	Values according ECP (1995)	
					Undrainage cohesion Cu [kN/m2]	Skin friction τ [kN/m2]
2	CL	5.5-10	75	2	75	35

Tarut Bridge - Analysis and design of foundation

Summary of results

File tip resistance (Given)

$s/D_f = 0.02$ Sig [kN/m²] = 800.000
 $s/D_f = 0.03$ Sig1 [kN/m²] = 1100.000
 $s/D_f = 0.10$ SigGR [kN/m²] = 2442.000

Internal results

Skin friction:

Layer No.	Layer thickness [m]	Penetration tip resistance [kN/m ²]	Undrainage cohesion of soil [kN/m ²]	Skin friction [kN/m ²]	Friction force [kN]
I	L1	qs	Cu	Tau	Qrg
[-]	[m]	[kN/m ²]	[kN/m ²]	[kN/m ²]	[kN]
1	5.50	-----	-----	0.000	0.0
2	4.50	-----	-----	35.000	593.8
3	18.00	-----	-----	100.000	6785.8

Sum of friction forces Qrf [kN] = 7379.6

Load on pile head Qma+Qsp = Qv [kN] = 2800.0
 Skin friction part from Qv Qma [kN] = 2444.1
 End bearing part from Qv Qsp [kN] = 355.9
 Expected settlement sv [cm] = 0.99

File resistance depending on pile settlement:

No.	Referred settlement	File tip settlement	File friction resistance	Tip resistance	File resistance
I	s/Df	s	Qr	Qs	Q
[-]	[-]	[cm]	[kN]	[kN]	[kN]
1	0.02	2.40	5903.7	904.8	6808.5
2	0.03	3.00	7379.6	1074.4	8454.0
3	0.03	3.60	7379.6	1244.1	8623.7
4	0.10	12.00	7379.6	2761.8	10141.4 = Qg=2*Qzul

Final results:

Allowable settlement Szul [cm] = 1.79
 Allowable pile load Qr+Qs = Qzul [kN] = 5070.7
 Skin friction part Qf [kN] = 4396.9
 End bearing part Qs [kN] = 673.9
 Safety factor Qzul/QV = ETHA [-] = 1.81

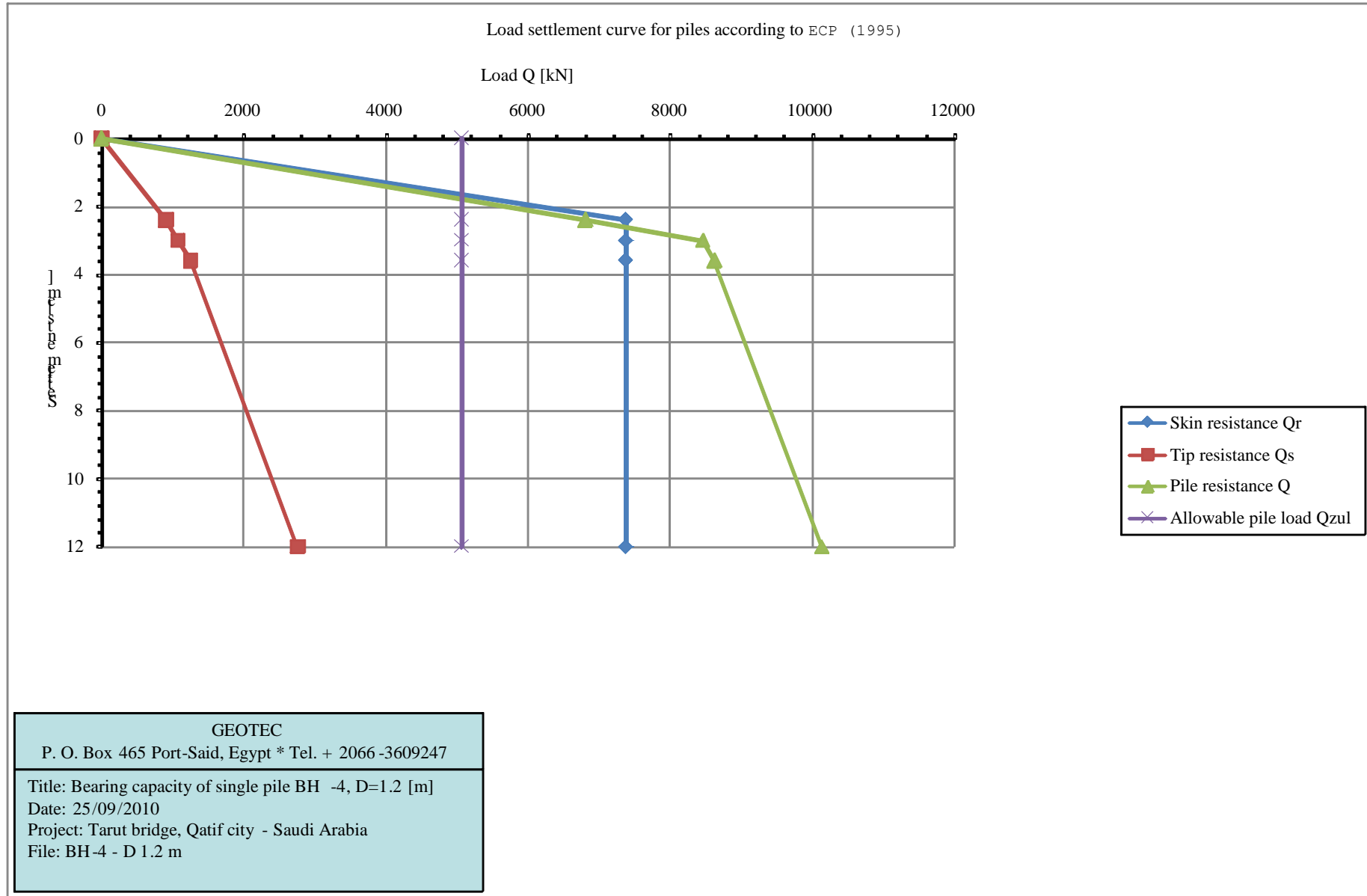

Tarut Bridge - Analysis and design of foundation

GeoTools

Version 2010

Program authors Prof. M. El Gendy/ Dr. A. El Gendy

Title: Bearing capacity of single pile BH-4, D=1.4 [m]

Date: 25/09/2010

Project: Tarut bridge, Qatif city- Saudi Arabia

File: BH-4 - D 1.4 m

 Bearing capacity and settlement of a single pile
 according to ECP (1995)

Data:

Pile diameter	D	[m]	=	1.40
Pile toe diameter	Df	[m]	=	1.40
Pile length	Lg	[m]	=	28.00

Soil property

Layer	Layer Depth Under the SBL [m]	Soil Type	Av. SPT N Value	Bulk Unit Wt. [kN/m3]	Angle of Int. friction Φ [deg]	Undrainage cohesion Cu [kN/m2]	Modulus of Elasticity E [kN/m2]
1	0-5.5	SP/SP-SM	7	16	30	-	18500
2	5.5-10	CL	2	15	-	75	10000
3	10-28	SP-SM/SM	38	19	36	-	43000

Estimation of pile skin friction for non-cohesive soil

Layer	Soil Type	Layer Depth Under the SBL [m]	Angle of Int. friction Φ [deg]	Av. SPT N Value	Values according ECP (1995)		
					depth	SPT	Skin friction τ [kN/m2]
1	SP/SP-SM	0-5.5	30	7	-	<10	0
3	SP-SM/SM	10-28	36	38	>10	>30	100

Estimation of pile skin friction for cohesive soil

Layer	Soil Type	Layer Depth Under the SBL [m]	Undrainage cohesion Cu [kN/m2]	Av. SPT N Value	Values according ECP (1995)	
					Undrainage cohesion Cu [kN/m2]	Skin friction τ [kN/m2]
2	CL	5.5-10	75	2	75	35

Tarut Bridge - Analysis and design of foundation

Summary of results

File tip resistance (Given)

$s/D_f = 0.02$ Sig [kN/m²] = 800.000
 $s/D_f = 0.03$ Sig1 [kN/m²] = 1100.000
 $s/D_f = 0.10$ SigGR [kN/m²] = 2442.000

Internal results

Skin friction:

Layer No.	Layer thickness [m]	Penetration tip resistance [kN/m ²]	Undrainage cohesion of soil [kN/m ²]	Skin friction [kN/m ²]	Friction force [kN]
I [-]	L1 [m]	qs [kN/m ²]	Cu [kN/m ²]	Tau [kN/m ²]	Qrg [kN]
1	5.50	-----	-----	0.000	0.0
2	4.50	-----	-----	35.000	692.7
3	18.00	-----	-----	100.000	7916.8

Sum of friction forces Qrf [kN] = 8609.5

Load on pile head Q_{ma}+Q_{sp} = Q_v [kN] = 3300.0
 Skin friction part from Q_v Q_{ma} [kN] = 2867.8
 End bearing part from Q_v Q_{sp} [kN] = 432.2
 Expected settlement sv [cm] = 1.00

File resistance depending on pile settlement:

No.	Referred settlement	File tip settlement	File friction resistance	Tip resistance	File resistance
I [-]	s/D _f [-]	s [cm]	Q _r [kN]	Q _s [kN]	Q [kN]
1	0.02	2.80	8035.6	1231.5	9267.1
2	0.02	3.00	8609.5	1297.5	9907.0
3	0.03	4.20	8609.5	1693.3	10302.9
4	0.10	14.00	8609.5	3759.2	12368.7 = Q _g =2*Q _{zul}

Final results:

Allowable settlement Szul [cm] = 1.87
 Allowable pile load Q_r+Q_s = Q_{zul} [kN] = 6184.4
 Skin friction part Q_r [kN] = 5362.5
 End bearing part Q_s [kN] = 821.8
 Safety factor Q_{zul}/Q_v = ETHA [-] = 1.87

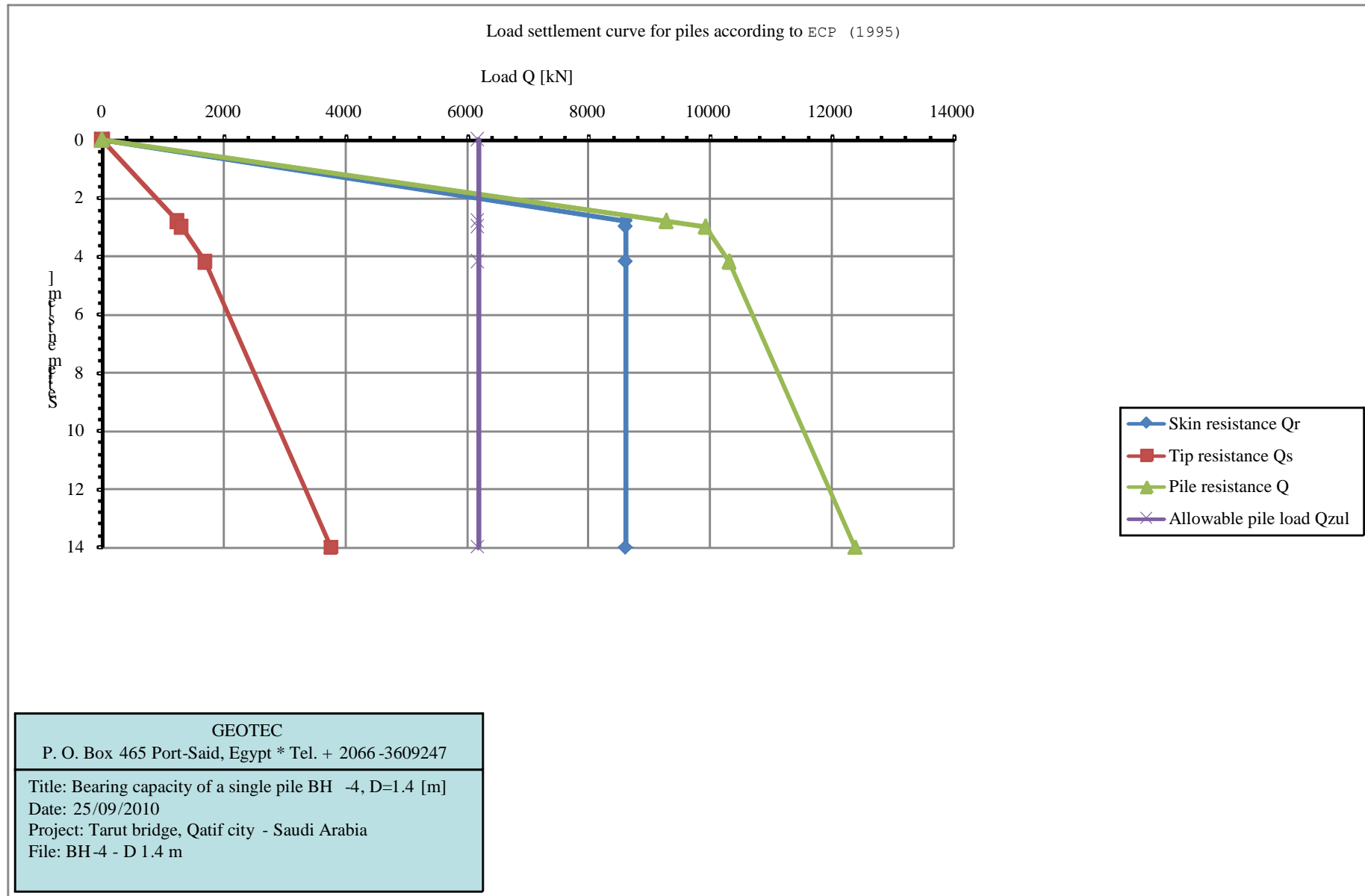

8 Pile foundation analysis - left side

```
*****
Analysis of slab foundation
by the program package ELPLA
Version 9.2 SP1
*****
```

Title: Pile cap analysis- left side
Date: 25/09/2010
Project: Tarut bridge, Qatif city- Saudi Arabia
File: Pile cap analysis

Calculation method:
Method (9) (Layered soil model)
Rigid free-standing raft

Program authors Prof. M. El Gendy/ Dr. A. El Gendy
GEOTEC Software Inc. PO Box 14001 Richmond Road PO, Calgary AB, Canada T3E 7Y7
www.geotecsoftware.com; geotec@geotecsoftware.com ; Tele.:+1(587) 332-3323

Tarut Bridge - Analysis and design of foundation

GEOTEC
PO Box 14001 Richmond Road PO, Calgary AB, Canada T3E 7Y7

Soil data

Title: Pile cap analysis- left side
Date: 25/09/2010
Project: Tarut bridge, Qatif city- Saudi Arabia
File: Pile cap analysis

Analysis of slab foundation
by the program package ELPLA
Version 9.2 SP1

Calculation method:
Method (9) (Layered soil model)
Rigid free-standing raft

Soil data

Groundwater depth under the ground surface GW [m] = 0
Settlement reduction factor Alfa [-] = 1

B o r i n g l a y e r s

Boring log No.: 1
Boring Log Label: B1
Location of boring in global coordinates system
Xb [m] = 0.00
Yb [m] = 0.00

Layer No.: 1
Symbole for soil type and rocks after DIN 4023: S
Level of layer under ground z [m] = 2.50
Modulus of Elasticity of the soil (Loading) E [kN/m2] = 18500
Modulus of Elasticity of the soil (Reloading) W [kN/m2] = 18500
Poisson's ratio of soil Nue [-] = 0.30
Unit weight of the soil Gama [kN/m3] = 6.2
Angle of internal friction Fhi [°] = 30.00
Cohesion of the soil c [kN/m2] = 0

Layer No.: 2
Symbole for soil type and rocks after DIN 4023: T
Level of layer under ground z [m] = 5.00
Modulus of Elasticity of the soil (Loading) E [kN/m2] = 10000
Modulus of Elasticity of the soil (Reloading) W [kN/m2] = 10000
Poisson's ratio of soil Nue [-] = 0.30
Unit weight of the soil Gama [kN/m3] = 5.2
Angle of internal friction Fhi [°] = 0.00
Cohesion of the soil c [kN/m2] = 75

Layer No.: 3
Symbole for soil type and rocks after DIN 4023: S
Level of layer under ground z [m] = 20.00
Modulus of Elasticity of the soil (Loading) E [kN/m2] = 43000
Modulus of Elasticity of the soil (Reloading) W [kN/m2] = 43000
Poisson's ratio of soil Nue [-] = 0.30
Unit weight of the soil Gama [kN/m3] = 9.2
Angle of internal friction Fhi [°] = 36.00
Cohesion of the soil c [kN/m2] = 0

Layer No.: 4
Symbole for soil type and rocks after DIN 4023: T
Level of layer under ground z [m] = 50.00
Modulus of Elasticity of the soil (Loading) E [kN/m2] = 47000
Modulus of Elasticity of the soil (Reloading) W [kN/m2] = 47000
Poisson's ratio of soil Nue [-] = 0.30
Unit weight of the soil Gama [kN/m3] = 9.7
Angle of internal friction Fhi [°] = 0.00
Cohesion of the soil c [kN/m2] = 200

Tarut Bridge - Analysis and design of foundation

GEOTEC
PO Box 14001 Richmond Road PO, Calgary AB, Canada T3E 7Y7

Slab properties/ Foundation level/ Global coordinates

Title: Pile cap analysis- left side
Date: 25/09/2010
Project: Tarut bridge, Qatif city- Saudi Arabia
File: Pile cap analysis

Analysis of slab foundation
by the program package ELPLA
Version 9.2 SP1

Calculation method:
Method (9) (Layered soil model)
Rigid free-standing raft

Slab properties/ Foundation level/ Global coordinates

Unit weight of slab material GB [kN/m3] = 25.0

Element groups (with the same thickness and material):

Group No.	E-Modulus of slab Ep [kN/m2]	Poisson's ratio Nue [-]	Slab thickness d [m]
1	2.4E+07	0.2	0.5
2	2.4E+07	0.2	1.36
3	2.4E+07	0.2	3.29
4	2.4E+07	0.2	1.69

Tarut Bridge - Analysis and design of foundation

GEOTEC
PO Box 14001 Richmond Road PO, Calgary AB, Canada T3E 7Y7

----- Loads -----

Title: Pile cap analysis- left side
Date: 25/09/2010
Project: Tarut bridge, Qatif city- Saudi Arabia
File: Pile cap analysis

Analysis of slab foundation
by the program package ELPLA
Version 9.2 SP1

Calculation method:
Method (9) (Layered soil model)
Rigid free-standing raft

L o a d i n g

Line loads:

Load No.	Load start value	Load end value	Load start	Load start	Load end	Load end
I	P1	P1	x1	y1	x2	y2
[-]	[kN/m]	[kN/m]	[m]	[m]	[m]	[m]
1	384	384	48.86	30.5	48.86	0

Distributed loads (Rectangle):

Load No.	Load value	Load start	Load start	Load end	Load end
I	P	x1	y1	x2	y2
[-]	[kN/m2]	[m]	[m]	[m]	[m]
1	13.1	0	30.5	51.112	0

Tarut Bridge - Analysis and design of foundation

GEOTEC
PO Box 14001 Richmond Road PO, Calgary AB, Canada T3E 7Y7

Loads

Loading data:

Distribute column loads: (No)			
Slab weight	Pe	[kN]	= 36364.4
Force on slab	Pa	[kN]	= 92934.3
Groundwater force	Pw	[kN]	= 0.0
Total load ($P = Pe + Pa - Pw$)	P	[kN]	= 129298.7
Groundwater pressure on raft	Qw	[kN/m ²]	= 0.0
Average contact pressure	Qo	[kN/m ²]	= 82.9
Sum Mx from loads	Mx	[kN.m]	= -1.1
Sum My from loads	My	[kN.m]	= 566599.3
Eccentricity of loading in x-direction	ex	[cm]	= 438.21
Eccentricity of loading in y-direction	ey	[cm]	= 0.00
Moment of inertia of slab about x-Axis	Ix	[m ⁴]	= 120848.60
Moment of inertia of slab about y-Axis	Iy	[m ⁴]	= 339379.81
Product of inertia	Ixy	[m ⁴]	= -0.02
Area of the slab	A	[m ²]	= 1558.92
Volume of the slab	V	[m ³]	= 1454.58

Tarut Bridge - Analysis and design of foundation

GEOTEC
PO Box 14001 Richmond Road PO, Calgary AB, Canada T3E 7Y7

Data of piles

Title: Pile cap analysis- left side
Date: 25/09/2010
Project: Tarut bridge, Qatif city- Saudi Arabia
File: Pile cap analysis

Analysis of slab foundation
by the program package ELPLA
Version 9.2 SP1

Calculation method:
Method (9) (Layered soil model)
Rigid free-standing raft

File groups:

Group No.: 1
Description of pile groups: P1
Pile diameter D [m] = 1.2
Pile toe diameter Df [m] = 1.2
Pile length Lg [m] = 28

Soil data under the pile tip:
Pile tip resistance (s/Df = 0.02) Sig [kN/m2] = 500
Pile tip resistance (s/Df = 0.03) Sig1 [kN/m2] = 700
Pile tip resistance (s/Df = 0.1) SigGR [kN/m2] = 1200

Geotechnical data of the layer:

Layer No.	Layer thickness L1 [m]	Undrainage cohesion Cu [kN/m2]	Penetration resistance qs [kN/m2]	Skin friction Tau [kN/m2]
1	2.50	---	---	0.0
2	2.50	---	---	35.0
3	15.00	---	---	100.0
4	8.00	---	---	50.0

File locations and groups:

Pile No.	Node No.	X-coord. [m]	Y-coord. [m]	Group No.
1	164	1.88	1.00	1
2	364	1.88	5.00	1
3	564	1.88	9.00	1
4	764	1.88	13.00	1
5	964	1.88	17.50	1
6	1164	1.88	21.50	1
7	1364	1.88	25.50	1
8	1564	1.88	29.50	1
9	172	9.71	1.00	1
10	372	9.71	5.00	1
11	572	9.71	9.00	1
12	772	9.71	13.00	1
13	972	9.71	17.50	1
14	1172	9.71	21.50	1
15	1372	9.71	25.50	1

Continue of table at next page

Tarut Bridge - Analysis and design of foundation

GEOTEC

PO Box 14001 Richmond Road PO, Calgary AB, Canada T3E 7Y7

Data of piles

Continue of table

File No. [-]	Node No. [-]	X-coord. [m]	Y-coord. [m]	Group No. [-]
16	1572	9.71	29.50	1
17	180	17.54	1.00	1
18	380	17.54	5.00	1
19	580	17.54	9.00	1
20	780	17.54	13.00	1
21	980	17.54	17.50	1
22	1180	17.54	21.50	1
23	1380	17.54	25.50	1
24	1580	17.54	29.50	1
25	188	25.37	1.00	1
26	388	25.37	5.00	1
27	588	25.37	9.00	1
28	788	25.37	13.00	1
29	988	25.37	17.50	1
30	1188	25.37	21.50	1
31	1388	25.37	25.50	1
32	1588	25.37	29.50	1
33	196	33.20	1.00	1
34	396	33.20	5.00	1
35	596	33.20	9.00	1
36	796	33.20	13.00	1
37	996	33.20	17.50	1
38	1196	33.20	21.50	1
39	1396	33.20	25.50	1
40	1596	33.20	29.50	1
41	204	41.03	1.00	1
42	404	41.03	5.00	1
43	604	41.03	9.00	1
44	804	41.03	13.00	1
45	1004	41.03	17.50	1
46	1204	41.03	21.50	1
47	1404	41.03	25.50	1
48	1604	41.03	29.50	1
49	212	49.91	1.00	1
50	210	47.41	1.00	1
51	410	47.41	5.00	1
52	412	49.91	5.00	1
53	610	47.41	9.00	1
54	612	49.91	9.00	1
55	810	47.41	13.00	1
56	812	49.91	13.00	1
57	1010	47.41	17.50	1
58	1012	49.91	17.50	1
59	1210	47.41	21.50	1
60	1212	49.91	21.50	1
61	1410	47.41	25.50	1
62	1412	49.91	25.50	1
63	1610	47.41	29.50	1
64	1612	49.91	29.50	1

File material:

Modulus of elasticity of pile E_p [kN/m²] = 24000000.00

Unit weight of pile concrete GP [kN/m³] = 30.00

The 5 m pile length above the bed level is considered by assuming an equivalent unit weight of pile concrete)

Tarut Bridge - Analysis and design of foundation

GEOTEC
PO Box 14001 Richmond Road PO, Calgary AB, Canada T3E 7Y7

Support reactions

Title: Pile cap analysis- left side
Date: 25/09/2010
Project: Tarut bridge, Qatif city- Saudi Arabia
File: Pile cap analysis

Analysis of slab foundation
by the program package ELPLA
Version 9.2 SP1

Calculation method:
Method (9) (Layered soil model)
Rigid free-standing raft

Support reactions

Node No.	Load-V	Moment-Y	Moment-X
I	V	My	Mx
[-]	[kN]	[kN.m]	[kN.m]
164	2356.5	0.0	0.0
172	2149.4	0.0	0.0
180	2152.5	0.0	0.0
188	2243.7	0.0	0.0
196	2386.2	0.0	0.0
204	2573.7	0.0	0.0
210	2823.9	0.0	0.0
212	3172.3	0.0	0.0
364	2008.3	0.0	0.0
372	1770.0	0.0	0.0
380	1755.2	0.0	0.0
388	1823.2	0.0	0.0
396	1933.4	0.0	0.0
404	2072.9	0.0	0.0
410	2285.7	0.0	0.0
412	2621.7	0.0	0.0
564	1839.0	0.0	0.0
572	1585.8	0.0	0.0
580	1560.3	0.0	0.0
588	1616.2	0.0	0.0
596	1710.9	0.0	0.0
604	1835.6	0.0	0.0
610	2053.2	0.0	0.0
612	2379.4	0.0	0.0
764	1774.5	0.0	0.0
772	1514.2	0.0	0.0
780	1483.1	0.0	0.0
788	1533.6	0.0	0.0
796	1622.3	0.0	0.0
804	1744.6	0.0	0.0
810	1973.0	0.0	0.0
812	2295.3	0.0	0.0
964	1774.5	0.0	0.0
972	1514.2	0.0	0.0
980	1483.1	0.0	0.0
988	1533.6	0.0	0.0
996	1622.3	0.0	0.0
1004	1744.6	0.0	0.0

Continue of table at next page

Tarut Bridge - Analysis and design of foundation

GEOTEC
PO Box 14001 Richmond Road PO, Calgary AB, Canada T3E 7Y7

Support reactions

Continue of table

Node No. I [-]	Load-V V [kN]	Moment-Y My [kN.m]	Moment-X Mx [kN.m]
1010	1973.0	0.0	0.0
1012	2295.3	0.0	0.0
1164	1839.0	0.0	0.0
1172	1585.8	0.0	0.0
1180	1560.3	0.0	0.0
1188	1616.2	0.0	0.0
1196	1710.9	0.0	0.0
1204	1835.6	0.0	0.0
1210	2053.2	0.0	0.0
1212	2379.4	0.0	0.0
1364	2008.3	0.0	0.0
1372	1770.0	0.0	0.0
1380	1755.2	0.0	0.0
1388	1823.2	0.0	0.0
1396	1933.4	0.0	0.0
1404	2072.9	0.0	0.0
1410	2285.7	0.0	0.0
1412	2621.7	0.0	0.0
1564	2356.5	0.0	0.0
1572	2149.4	0.0	0.0
1580	2152.5	0.0	0.0
1588	2243.7	0.0	0.0
1596	2386.2	0.0	0.0
1604	2573.7	0.0	0.0
1610	2823.9	0.0	0.0
1612	3172.3	0.0	0.0

Sum. V 129298.7

Tarut Bridge - Analysis and design of foundation

GEOTEC
PO Box 14001 Richmond Road PO, Calgary AB, Canada T3E 7Y7

File results

Title: Pile cap analysis- left side
Date: 25/09/2010
Project: Tarut bridge, Qatif city- Saudi Arabia
File: Pile cap analysis

Analysis of slab foundation
by the program package ELPLA
Version 9.2 SP1

Calculation method:
Method (9) (Layered soil model)
Rigid free-standing raft

File results

Value of total load (including own wt.)	Po	[kN] = 129298.7
Total pile loads	PL	[kN] = 129298.7
Bearing factor of piled raft	Alfa-Kpp	[%] = 100.00

File loads and displacements

Pile No.	pile load	Settlement	Soil stiffness
I	Fr	Sr	ks
[-]	[kN]	[cm]	[kN/m]
1	2356.5	2.14	109946.4
2	2008.3	1.81	111192.1
3	1839.0	1.99	92329.7
4	1774.5	1.93	91989.3
5	1774.5	1.62	109316.3
6	1839.0	1.84	100078.2
7	2008.3	1.81	111192.1
8	2356.5	1.55	152232.4
9	2149.4	1.87	115007.5
10	1770.0	1.81	97997.9
11	1585.8	2.28	69472.3
12	1514.2	1.71	88304.6
13	1514.2	1.68	89950.5
14	1585.8	2.19	72351.4
15	1770.0	1.88	94209.4
16	2149.4	1.58	136367.0
17	2152.5	2.14	100429.1
18	1755.2	1.59	110256.9
19	1560.3	1.56	99988.3
20	1483.1	2.07	71734.1
21	1483.1	1.76	84461.8
22	1560.3	2.22	70140.0
23	1755.2	1.92	91583.3
24	2152.5	1.61	133898.0
25	2243.7	2.21	101573.8
26	1823.2	1.94	93752.2
27	1616.2	1.63	98962.1
28	1533.6	2.10	73065.1
29	1533.6	1.79	85501.1
30	1616.2	2.26	71417.4
31	1823.2	1.94	93752.2
32	2243.7	1.73	129661.1
33	2386.2	1.51	157994.5

Continue of table at next page

Tarut Bridge - Analysis and design of foundation

GEOTEC
PO Box 14001 Richmond Road PO, Calgary AB, Canada T3E 7Y7

File results

Continue of table

File No.	pile load Fr [kN]	Settlement Sr [cm]	Soil stiffness ks [kN/m]
34	1933.4	1.98	97840.8
35	1710.9	1.67	102402.8
36	1622.3	2.12	76361.8
37	1622.3	1.82	89045.7
38	1710.9	1.61	106430.0
39	1933.4	1.63	118385.9
40	2386.2	1.92	124510.7
41	2573.7	1.55	166263.5
42	2072.9	2.00	103559.5
43	1835.6	1.70	108037.8
44	1744.6	2.26	77091.3
45	1744.6	1.51	115512.5
46	1835.6	1.79	102339.8
47	2072.9	1.79	115570.0
48	2573.7	2.30	111828.6
49	3172.3	1.58	201263.0
50	2823.9	1.76	160817.1
51	2285.7	2.24	101886.5
52	2621.7	2.12	123406.1
53	2053.2	2.14	95794.8
54	2379.4	2.16	110047.0
55	1973.0	1.53	129025.3
56	2295.3	1.67	137377.4
57	1973.0	1.50	131564.2
58	2295.3	1.92	119767.0
59	2053.2	2.30	89212.1
60	2379.4	2.30	103385.1
61	2285.7	2.05	111398.7
62	2621.7	1.79	146169.8
63	2823.9	1.65	170942.4
64	3172.3	1.51	210043.3

File loads

File No.	Skin resistance Qma [kN]	Tip resistance Qsp [kN]	Total load Fr [kN]
1	2081.2	188.5	2356.5
2	1808.0	163.7	2008.3
3	1673.6	151.6	1839.0
4	1621.4	146.8	1774.5
5	1621.4	146.8	1774.5
6	1673.6	151.6	1839.0
7	1808.0	163.7	2008.3
8	2081.2	188.5	2356.5
9	1916.1	173.5	2149.4
10	1628.3	147.5	1770.0
11	1486.4	134.6	1585.8
12	1430.2	129.5	1514.2
13	1430.2	129.5	1514.2
14	1486.4	134.6	1585.8
15	1628.3	147.5	1770.0
16	1916.1	173.5	2149.4
17	1920.6	173.9	2152.5

Continue of table at next page

Tarut Bridge - Analysis and design of foundation

GEOTEC

PO Box 14001 Richmond Road PO, Calgary AB, Canada T3E 7Y7

 File results

Continue of table

File No. I [-]	Skin resistance Q _{ma} [kN]	Tip resistance Q _{sp} [kN]	Total load Fr [kN]
18	1622.5	146.9	1755.2
19	1473.8	133.5	1560.3
20	1413.9	128.1	1483.1
21	1413.9	128.1	1483.1
22	1473.8	133.5	1560.3
23	1622.5	146.9	1755.2
24	1920.6	173.9	2152.5
25	2000.2	181.1	2243.7
26	1686.3	152.7	1823.2
27	1528.8	138.5	1616.2
28	1465.0	132.7	1533.6
29	1465.0	132.7	1533.6
30	1528.8	138.5	1616.2
31	1686.3	152.7	1823.2
32	2000.2	181.1	2243.7
33	2126.8	192.6	2386.2
34	1788.9	162.0	1933.4
35	1619.7	146.7	1710.9
36	1551.1	140.5	1622.3
37	1551.1	140.5	1622.3
38	1619.7	146.7	1710.9
39	1788.9	162.0	1933.4
40	2126.8	192.6	2386.2
41	2296.3	208.0	2573.7
42	1921.0	174.0	2072.9
43	1738.9	157.5	1835.6
44	1667.4	151.0	1744.6
45	1667.4	151.0	1744.6
46	1738.9	157.5	1835.6
47	1921.0	174.0	2072.9
48	2296.3	208.0	2573.7
49	2785.3	252.3	3172.3
50	2517.2	228.0	2823.9
51	2107.1	190.8	2285.7
52	2359.4	213.7	2621.7
53	1923.6	174.2	2053.2
54	2166.6	196.2	2379.4
55	1857.8	168.3	1973.0
56	2097.2	189.9	2295.3
57	1857.8	168.3	1973.0
58	2097.2	189.9	2295.3
59	1923.6	174.2	2053.2
60	2166.6	196.2	2379.4
61	2107.1	190.8	2285.7
62	2359.4	213.7	2621.7
63	2517.2	228.0	2823.9
64	2785.3	252.3	3172.3

Tarut Bridge - Analysis and design of foundation

GEOTEC

PO Box 14001 Richmond Road PO, Calgary AB, Canada T3E 7Y7

 File results

File settlements

Pile No. I [-]	Self settlement Sv [cm]	Settlement Sr-Sv [cm]	Sum of settlements Sr [cm]
1	0.83	1.31	2.14
2	0.72	1.08	1.81
3	0.67	1.32	1.99
4	0.65	1.28	1.93
5	0.65	0.98	1.62
6	0.67	1.17	1.84
7	0.72	1.08	1.81
8	0.83	0.72	1.55
9	0.76	1.10	1.87
10	0.65	1.16	1.81
11	0.59	1.69	2.28
12	0.57	1.14	1.71
13	0.57	1.11	1.68
14	0.59	1.60	2.19
15	0.65	1.23	1.88
16	0.76	0.81	1.58
17	0.77	1.38	2.14
18	0.65	0.94	1.59
19	0.59	0.97	1.56
20	0.56	1.50	2.07
21	0.56	1.19	1.76
22	0.59	1.64	2.22
23	0.65	1.27	1.92
24	0.77	0.84	1.61
25	0.80	1.41	2.21
26	0.67	1.27	1.94
27	0.61	1.02	1.63
28	0.58	1.51	2.10
29	0.58	1.21	1.79
30	0.61	1.65	2.26
31	0.67	1.27	1.94
32	0.80	0.93	1.73
33	0.85	0.66	1.51
34	0.71	1.26	1.98
35	0.65	1.02	1.67
36	0.62	1.51	2.12
37	0.62	1.20	1.82
38	0.65	0.96	1.61
39	0.71	0.92	1.63
40	0.85	1.07	1.92
41	0.92	0.63	1.55
42	0.77	1.24	2.00
43	0.69	1.01	1.70
44	0.67	1.60	2.26
45	0.67	0.84	1.51
46	0.69	1.10	1.79
47	0.77	1.03	1.79
48	0.92	1.39	2.30
49	1.11	0.46	1.58
50	1.00	0.75	1.76
51	0.84	1.40	2.24
52	0.94	1.18	2.12
53	0.77	1.38	2.14
54	0.86	1.30	2.16
55	0.74	0.79	1.53
56	0.84	0.83	1.67

Continue of table at next page

Tarut Bridge - Analysis and design of foundation

GEOTEC
PO Box 14001 Richmond Road PO, Calgary AB, Canada T3E 7Y7

File results

Continue of table

File No.	Self settlement I [-]	Settlement Sv [cm]	Settlement Sr-Sv [cm]	Sum of settlements Sr [cm]
57	0.74		0.76	1.50
58	0.84		1.08	1.92
59	0.77		1.53	2.30
60	0.86		1.44	2.30
61	0.84		1.21	2.05
62	0.94		0.85	1.79
63	1.00		0.65	1.65
64	1.11		0.40	1.51

GEOTEC Office Output Sample

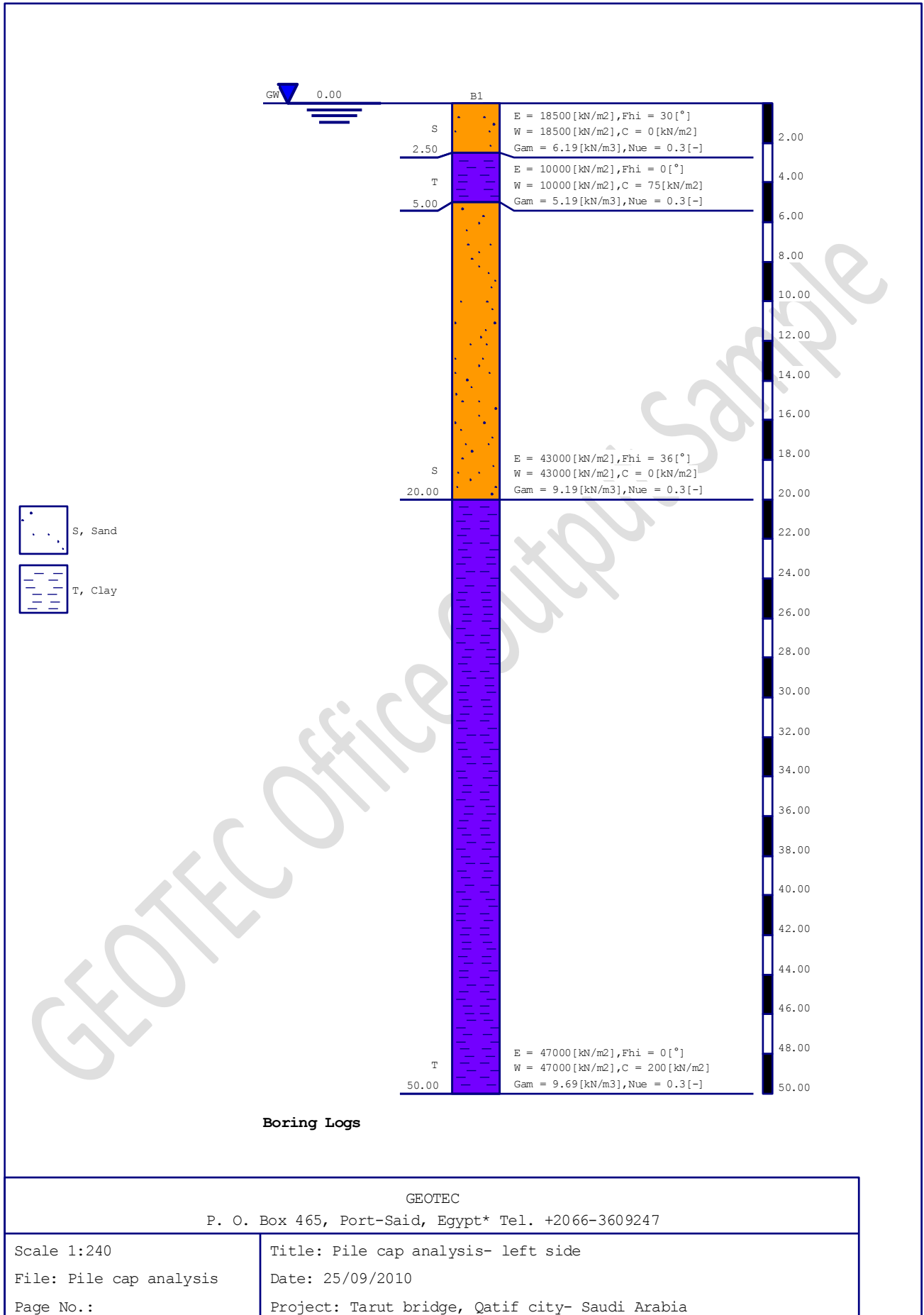

Tarut Bridge - Analysis and design of foundation

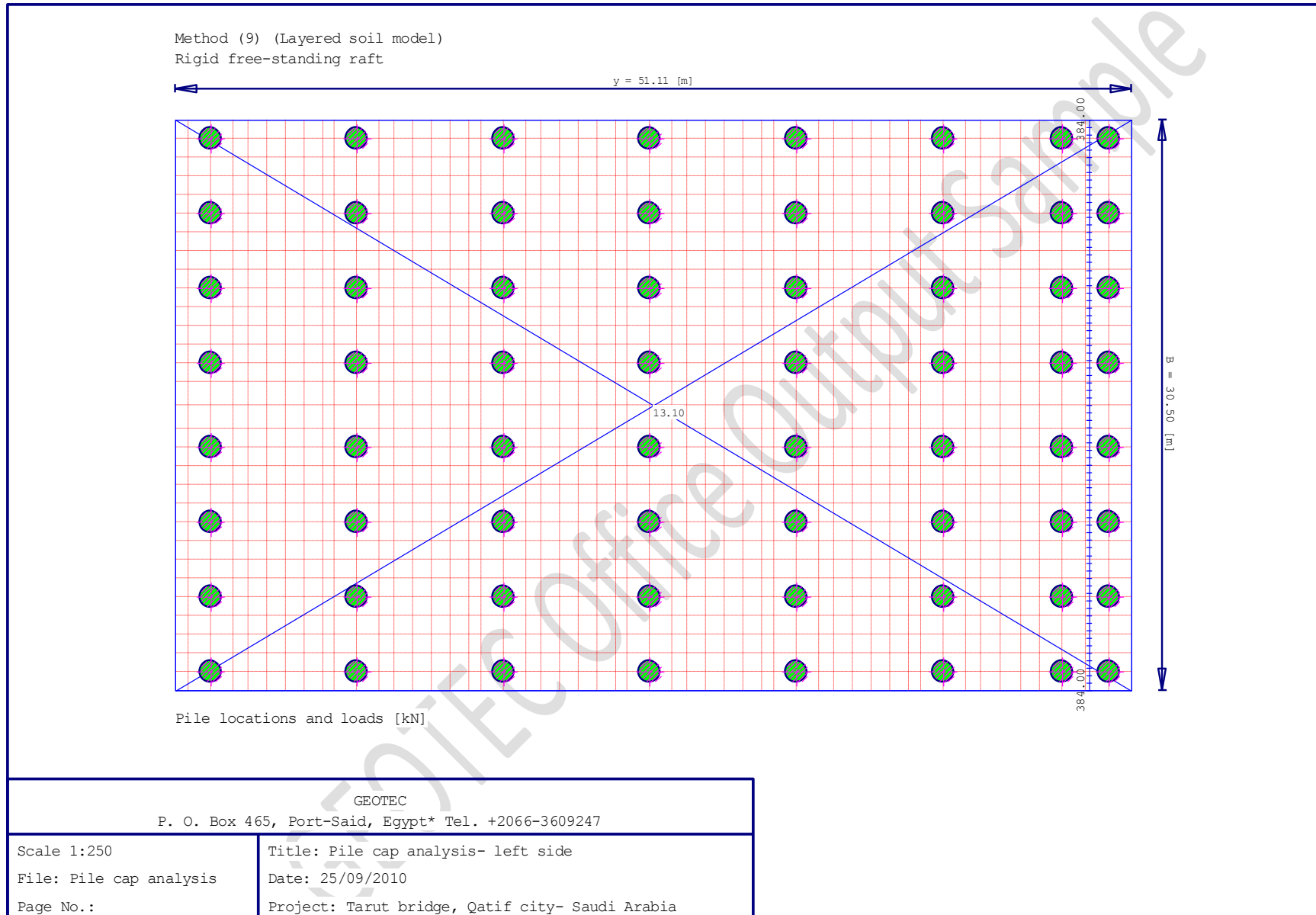

Tarut Bridge - Analysis and design of foundation

Method (9) (Layered soil model)
Rigid free-standing raft

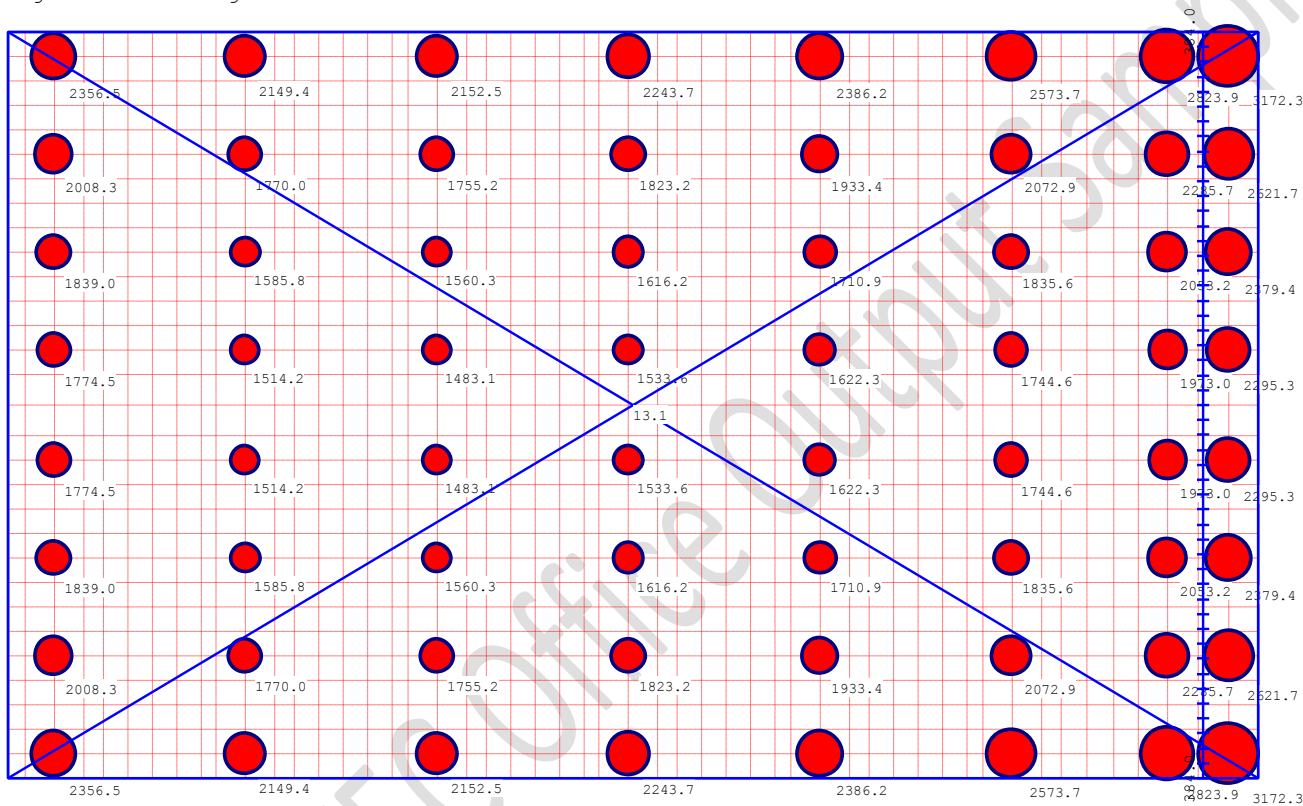

Support reactions V [kN]
Max. V = 3172.3 at node 212, Min. V = 1483.1 at node 780, Sum = 129298.7

GEOTEC Software P. O. Box 465, Port-Said, Egypt* Tel. +2066-3609247	
Scale 1:250 File: Pile cap analysis Page No.:	Title: Pile foundation analysis- left side Date: 25/09/2010 Project: Tarut bridge, Qatif city- Saudi Arabia

Method (9) (Layered soil model)
Rigid free-standing raft

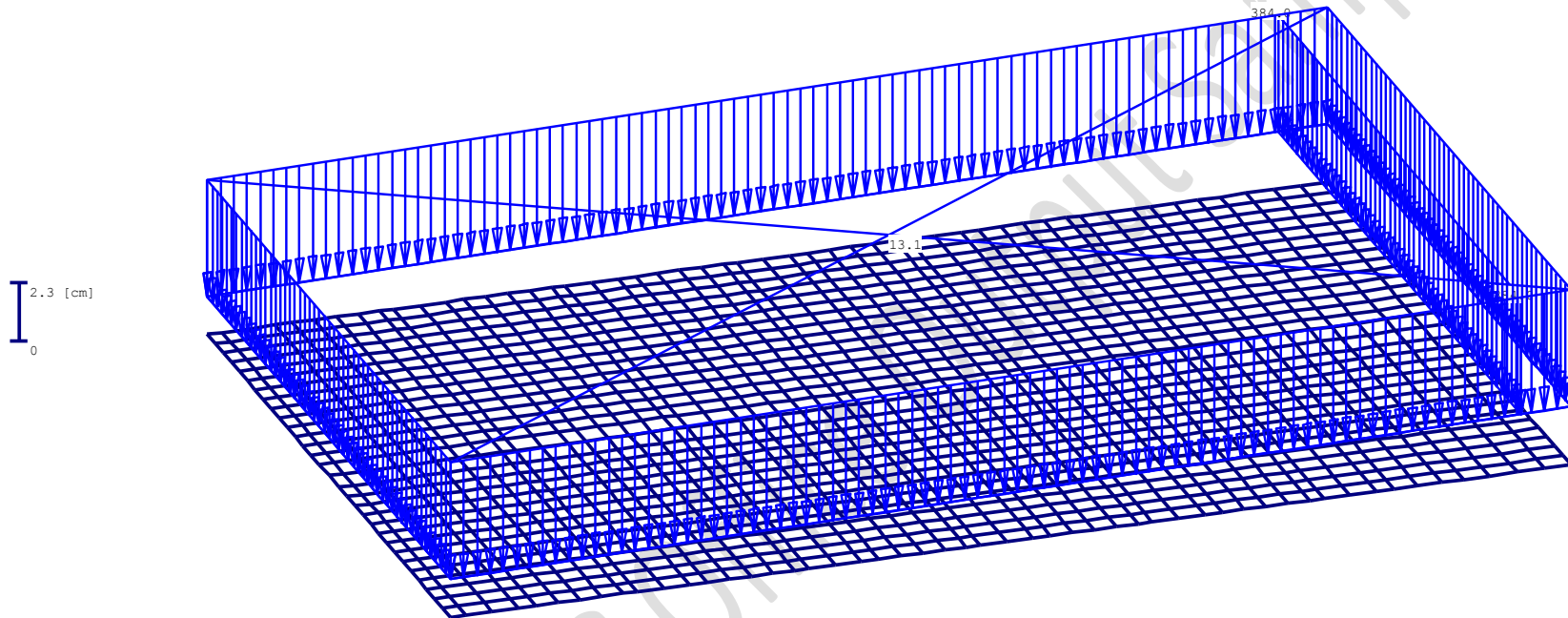

Slab deformation w [cm]
Max. w = 2.30 at node 3, Min. w = 1.50 at node 1

GEOtec Software P. O. Box 465, Port-Said, Egypt* Tel. +2066-3609247	
Scale factor: 250	Title: Pile foundation analysis- left side
File: Pile cap analysis	Date: 25/09/2010
Page No.:	Project: Tarut bridge, Qatif city- Saudi Arabia

9 Pile foundation design - left side

```
*****
                          Analysis of slab foundation
                          by the program package ELPLA
                          Version 9.2 SP1
*****
```

Title: Pile cap design-left side
Date: 25/09/2010
Project: Tarut bridge, Qatif city- Saudi Arabia
File: Pile cap design

Calculation method:
Method (3)
Modulus of subgrade reaction is defined by the user

Program authors Prof. M. El Gendy/ Dr. A. El Gendy
GEOTEC Software Inc. PO Box 14001 Richmond Road PO, Calgary AB, Canada T3E 7Y7
www.geotecsoftware.com; geotec@geotecsoftware.com ; Tele.:+1(587) 332-3323

Tarut Bridge - Analysis and design of foundation

GEOTEC

PO Box 14001 Richmond Road PO, Calgary AB, Canada T3E 7Y7

Slab properties/ Foundation level/ Global coordinates

Title: Pile cap design-left side
Date: 25/09/2010
Project: Tarut bridge, Qatif city- Saudi Arabia
File: Pile cap design

Analysis of slab foundation
by the program package ELPLA
Version 9.2 SP1

Calculation method:
Method (3)
Modulus of subgrade reaction is defined by the user

Slab properties/ Foundation level/ Global coordinates

Unit weight of slab material GB [kN/m3] = 25.0

Element groups (with the same thickness and material):

Group No.	E-Modulus of slab Ep [kN/m2]	Poisson's ratio Nue [-]	Slab thickness d [m]
1	2.4E+07	0.2	0.5
2	2.4E+07	0.2	1.36
3	2.4E+07	0.2	3.29
4	2.4E+07	0.2	1.69

Tarut Bridge - Analysis and design of foundation

GEOTEC
PO Box 14001 Richmond Road PO, Calgary AB, Canada T3E 7Y7

----- Loads -----

Title: Pile cap design-left side
Date: 25/09/2010
Project: Tarut bridge, Qatif city- Saudi Arabia
File: Pile cap design

Analysis of slab foundation
by the program package ELPLA
Version 9.2 SP1

Calculation method:
Method (3)
Modulus of subgrade reaction is defined by the user

L o a d i n g

Line loads:

Load No.	Load start value	Load end value	Load start	Load start	Load end	Load end
I	P1	P1	x1	y1	x2	y2
[-]	[kN/m]	[kN/m]	[m]	[m]	[m]	[m]
1	384	384	48.86	30.5	48.86	0

Distributed loads (Rectangle):

Load No.	Load value	Load start	Load start	Load end	Load end
I	P	x1	y1	x2	y2
[-]	[kN/m2]	[m]	[m]	[m]	[m]
1	13.1	0	30.5	51.112	0

Tarut Bridge - Analysis and design of foundation

GEOTEC
PO Box 14001 Richmond Road PO, Calgary AB, Canada T3E 7Y7

Loads

Loading data:

Distribute column loads: (No)

Slab weight	Pe [kN]	=	36364.4
Force on slab	Pa [kN]	=	92934.3
Groundwater force	Pw [kN]	=	0.0
Total load ($P = Pe + Pa - Pw$)	P [kN]	=	129298.7
Groundwater pressure on raft	Qw [kN/m ²]	=	0.0
Average contact pressure	Qo [kN/m ²]	=	82.9

Sum Mx from loads	Mx [kN.m]	=	-1.1
Sum My from loads	My [kN.m]	=	566599.3

Eccentricity of loading in x-direction	ex [cm]	=	438.21
Eccentricity of loading in y-direction	ey [cm]	=	0.00

Moment of inertia of slab about x-Axis	Ix [m ⁴]	=	120848.60
Moment of inertia of slab about y-Axis	Iy [m ⁴]	=	339379.81
Product of inertia	Ixy [m ⁴]	=	-0.02
Area of the slab	A [m ²]	=	1558.92
Volume of the slab	V [m ³]	=	1454.58

Tarut Bridge - Analysis and design of foundation

GEOTEC
PO Box 14001 Richmond Road PO, Calgary AB, Canada T3E 7Y7

Data of reinforcement

Title: Pile cap design-left side
Date: 25/09/2010
Project: Tarut bridge, Qatif city- Saudi Arabia
File: Pile cap design

Analysis of slab foundation
by the program package ELPLA
Version 9.2 SP1

Calculation method:
Method (3)
Modulus of subgrade reaction is defined by the user

Data of reinforcement (Design for flexural moment)

Design Code
Concrete grade C 300
Steel Grade S 36/52

Compressive strength	fc	[kN/m ²]	= 10500
Tensile strength	fs	[kN/m ²]	= 200000

Concrete cover+ 1/2 bar diameter			
X-direction top	d1x	[cm]	= 7
X-direction bottom	d2x	[cm]	= 7
Y-direction top	d1y	[cm]	= 7
Y-direction bottom	d2y	[cm]	= 7

Tarut Bridge - Analysis and design of foundation

GEOTEC
PO Box 14001 Richmond Road PO, Calgary AB, Canada T3E 7Y7

Data of piles

Title: Pile cap design-left side
Date: 25/09/2010
Project: Tarut bridge, Qatif city- Saudi Arabia
File: Pile cap design

Analysis of slab foundation
by the program package ELPLA
Version 9.2 SP1

Calculation method:
Method (3)
Modulus of subgrade reaction is defined by the user

File groups:

Group No.	Pile diameter	Pile length	Pile stiffness
I	D	L	kz
[-]	[m]	[m]	[kN/m]
1	1.20	28.00	154020.0
2	1.20	28.00	131261.0
3	1.20	28.00	120196.0
4	1.20	28.00	115980.0
5	1.20	28.00	130267.0
6	1.20	28.00	107273.0
7	1.20	28.00	96109.0
8	1.20	28.00	91770.0
9	1.20	28.00	121610.0
10	1.20	28.00	99164.0
11	1.20	28.00	88153.0
12	1.20	28.00	83791.0
13	1.20	28.00	118090.0
14	1.20	28.00	95958.0
15	1.20	28.00	85063.0
16	1.20	28.00	80716.0
17	1.20	28.00	118129.0
18	1.20	28.00	95713.0
19	1.20	28.00	84698.0
20	1.20	28.00	80312.0
21	1.20	28.00	120266.0
22	1.20	28.00	96865.0
23	1.20	28.00	85776.0
24	1.20	28.00	81523.0
25	1.20	28.00	126067.0
26	1.20	28.00	102040.0
27	1.20	28.00	91661.0
28	1.20	28.00	88080.0
29	1.20	28.00	139136.0
30	1.20	28.00	114987.0
31	1.20	28.00	104360.0
32	1.20	28.00	100671.0

File locations and groups:

Pile No.	Node No.	X-coord.	Y-coord.	Group No.
[-]	[-]	[m]	[m]	[-]
1	164	1.88	1.00	1

Continue of table at next page

Tarut Bridge - Analysis and design of foundation

GEOTEC
PO Box 14001 Richmond Road PO, Calgary AB, Canada T3E 7Y7

Data of piles

Continue of table

File No. [-]	Node No. [-]	X-coord. [m]	Y-coord. [m]	Group No. [-]
2	364	1.88	5.00	2
3	564	1.88	9.00	3
4	764	1.88	13.00	4
5	964	1.88	17.50	4
6	1164	1.88	21.50	3
7	1364	1.88	25.50	2
8	1564	1.88	29.50	1
9	172	9.71	1.00	5
10	372	9.71	5.00	6
11	572	9.71	9.00	7
12	772	9.71	13.00	8
13	972	9.71	17.50	8
14	1172	9.71	21.50	7
15	1372	9.71	25.50	6
16	1572	9.71	29.50	5
17	180	17.54	1.00	9
18	380	17.54	5.00	10
19	580	17.54	9.00	11
20	780	17.54	13.00	12
21	980	17.54	17.50	12
22	1180	17.54	21.50	11
23	1380	17.54	25.50	10
24	1580	17.54	29.50	9
25	188	25.37	1.00	13
26	388	25.37	5.00	14
27	588	25.37	9.00	15
28	788	25.37	13.00	16
29	988	25.37	17.50	16
30	1188	25.37	21.50	15
31	1388	25.37	25.50	14
32	1588	25.37	29.50	13
33	196	33.20	1.00	17
34	396	33.20	5.00	18
35	596	33.20	9.00	19
36	796	33.20	13.00	20
37	996	33.20	17.50	20
38	1196	33.20	21.50	19
39	1396	33.20	25.50	18
40	1596	33.20	29.50	17
41	204	41.03	1.00	21
42	404	41.03	5.00	22
43	604	41.03	9.00	23
44	804	41.03	13.00	24
45	1004	41.03	17.50	24
46	1204	41.03	21.50	23
47	1404	41.03	25.50	22
48	1604	41.03	29.50	21
49	212	49.91	1.00	29
50	210	47.41	1.00	25
51	410	47.41	5.00	26
52	412	49.91	5.00	30
53	610	47.41	9.00	27
54	612	49.91	9.00	31
55	810	47.41	13.00	28
56	812	49.91	13.00	32
57	1010	47.41	17.50	28
58	1012	49.91	17.50	32

Continue of table at next page

Tarut Bridge - Analysis and design of foundation

GEOTEC
PO Box 14001 Richmond Road PO, Calgary AB, Canada T3E 7Y7

Data of piles

Continue of table

File No. [-]	Node No. [-]	X-coord. [m]	Y-coord. [m]	Group No. [-]
59	1210	47.41	21.50	27
60	1212	49.91	21.50	31
61	1410	47.41	25.50	26
62	1412	49.91	25.50	30
63	1610	47.41	29.50	25
64	1612	49.91	29.50	29

File material:

Modulus of elasticity of pile E_p [kN/m²] = 24000000

Unit weight of pile concrete GP [kN/m³] = 30

The 5 m pile length above the bed level is considered by assuming
an equivalent unit weight of pile concrete)

Tarut Bridge - Analysis and design of foundation

GEOTEC
PO Box 14001 Richmond Road PO, Calgary AB, Canada T3E 7Y7

Support reactions

Title: Pile cap design-left side
Date: 25/09/2010
Project: Tarut bridge, Qatif city- Saudi Arabia
File: Pile cap design

Analysis of slab foundation
by the program package ELPLA
Version 9.2 SP1

Calculation method:
Method (3)
Modulus of subgrade reaction is defined by the user

Support reactions

Node No.	Load-V [kN]	Moment-Y [kN.m]	Moment-X [kN.m]
164	1546.5	0.0	0.0
172	1907.8	0.0	0.0
180	1857.0	0.0	0.0
188	1850.8	0.0	0.0
196	1842.2	0.0	0.0
204	2086.5	0.0	0.0
210	2523.1	0.0	0.0
212	2649.7	0.0	0.0
364	1628.0	0.0	0.0
372	1926.5	0.0	0.0
380	1885.6	0.0	0.0
388	1877.4	0.0	0.0
396	1862.8	0.0	0.0
404	2008.6	0.0	0.0
410	2257.6	0.0	0.0
412	2435.7	0.0	0.0
564	1704.7	0.0	0.0
572	1965.2	0.0	0.0
580	1926.9	0.0	0.0
588	1916.5	0.0	0.0
596	1897.9	0.0	0.0
604	1992.4	0.0	0.0
610	2183.9	0.0	0.0
612	2389.6	0.0	0.0
764	1759.4	0.0	0.0
772	2003.5	0.0	0.0
780	1964.8	0.0	0.0
788	1952.5	0.0	0.0
796	1932.1	0.0	0.0
804	2005.8	0.0	0.0
810	2184.8	0.0	0.0
812	2404.6	0.0	0.0
964	1758.8	0.0	0.0
972	2003.1	0.0	0.0
980	1964.7	0.0	0.0
988	1952.2	0.0	0.0
996	1932.0	0.0	0.0
1004	2006.3	0.0	0.0

Continue of table at next page

Tarut Bridge - Analysis and design of foundation

GEOTEC
PO Box 14001 Richmond Road PO, Calgary AB, Canada T3E 7Y7

Support reactions

Continue of table

Node No.	Load-V	Moment-Y	Moment-X
I	V	My	Mx
[-]	[kN]	[kN.m]	[kN.m]
1010	2185.3	0.0	0.0
1012	2405.2	0.0	0.0
1164	1703.1	0.0	0.0
1172	1964.3	0.0	0.0
1180	1926.8	0.0	0.0
1188	1915.8	0.0	0.0
1196	1897.7	0.0	0.0
1204	1993.8	0.0	0.0
1210	2185.8	0.0	0.0
1212	2391.9	0.0	0.0
1364	1625.8	0.0	0.0
1372	1925.5	0.0	0.0
1380	1885.7	0.0	0.0
1388	1876.5	0.0	0.0
1396	1862.5	0.0	0.0
1404	2010.8	0.0	0.0
1410	2261.6	0.0	0.0
1412	2440.4	0.0	0.0
1564	1544.2	0.0	0.0
1572	1906.9	0.0	0.0
1580	1857.7	0.0	0.0
1588	1850.1	0.0	0.0
1596	1841.9	0.0	0.0
1604	2089.9	0.0	0.0
1610	2530.0	0.0	0.0
1612	2657.7	0.0	0.0

Sum. V 128684.4

Tarut Bridge - Analysis and design of foundation

GEOTEC
PO Box 14001 Richmond Road PO, Calgary AB, Canada T3E 7Y7

File results

Title: Pile cap design-left side
Date: 25/09/2010
Project: Tarut bridge, Qatif city- Saudi Arabia
File: Pile cap design

Analysis of slab foundation
by the program package ELPLA
Version 9.2 SP1

Calculation method:
Method (3)
Modulus of subgrade reaction is defined by the user

File results

Value of total load (including own wt.) Po [kN] = 129298.7
Total pile loads PL [kN] = 128684.4
Bearing factor of piled raft Alfa-Kpp [%] = 99.52

File loads and displacements

Pile No.	pile load Fr [kN]	Settlement Sr [cm]	Soil stiffness ks [kN/m]
1	1546.5	1.00	154020.0
2	1628.0	1.24	131261.0
3	1704.7	1.42	120196.0
4	1759.4	1.52	115980.0
5	1758.8	1.52	115980.0
6	1703.1	1.42	120196.0
7	1625.8	1.24	131261.0
8	1544.2	1.00	154020.0
9	1907.8	1.46	130267.0
10	1926.5	1.80	107273.0
11	1965.2	2.04	96109.0
12	2003.5	2.18	91770.0
13	2003.1	2.18	91770.0
14	1964.3	2.04	96109.0
15	1925.5	1.79	107273.0
16	1906.9	1.46	130267.0
17	1857.0	1.53	121610.0
18	1885.6	1.90	99164.0
19	1926.9	2.19	88153.0
20	1964.8	2.34	83791.0
21	1964.7	2.34	83791.0
22	1926.8	2.19	88153.0
23	1885.7	1.90	99164.0
24	1857.7	1.53	121610.1
25	1850.8	1.57	118090.0
26	1877.4	1.96	95958.0
27	1916.5	2.25	85063.0
28	1952.5	2.42	80716.0
29	1952.2	2.42	80716.0
30	1915.8	2.25	85063.0
31	1876.5	1.96	95958.0
32	1850.1	1.57	118090.0
33	1842.2	1.56	118129.0

Continue of table at next page

Tarut Bridge - Analysis and design of foundation

GEOTEC
PO Box 14001 Richmond Road PO, Calgary AB, Canada T3E 7Y7

File results

Continue of table

File No. I [-]	pile load Fr [kN]	Settlement Sr [cm]	Soil stiffness ks [kN/m]
34	1862.8	1.95	95713.0
35	1897.9	2.24	84698.0
36	1932.1	2.41	80312.0
37	1932.0	2.41	80312.0
38	1897.7	2.24	84698.0
39	1862.5	1.95	95713.0
40	1841.9	1.56	118129.0
41	2086.5	1.73	120266.1
42	2008.6	2.07	96865.0
43	1992.4	2.32	85776.0
44	2005.8	2.46	81523.0
45	2006.3	2.46	81523.0
46	1993.8	2.32	85776.0
47	2010.8	2.08	96865.0
48	2089.9	1.74	120266.0
49	2649.7	1.90	139136.0
50	2523.1	2.00	126067.0
51	2257.6	2.21	102040.0
52	2435.7	2.12	114987.0
53	2183.9	2.38	91661.0
54	2389.6	2.29	104360.0
55	2184.8	2.48	88080.0
56	2404.6	2.39	100671.0
57	2185.3	2.48	88080.0
58	2405.2	2.39	100671.0
59	2185.8	2.38	91661.0
60	2391.9	2.29	104360.0
61	2261.6	2.22	102040.0
62	2440.4	2.12	114987.0
63	2530.0	2.01	126067.0
64	2657.7	1.91	139136.0

Tarut Bridge - Analysis and design of foundation

Punching Shear

Node No.	Load value	X-coord.	Y-coord.	Pile diameter	Punching shear stress	Stress on the column	Area of critical section of punching shear	Perimeter of critical section of punching shear	Effective depth of the section of punching shear	Punching shear stress ratio
I [-]	Pc [kN]	Xc [m]	Yc [m]	a [m]	Qp [kN/m ²]	Qo [kN/m ²]	PA [m ²]	AL [m]	Dp [m]	Rpa [%]
1	1546.5	1.88	1	1.2	165.2	47	4.52	6.26	1.29	3.03
2	1628	1.88	5	1.2	140.1	47	4.75	7.77	1.29	3.57
3	1704.7	1.88	9	1.2	147.8	47	4.75	7.77	1.29	3.38
4	1759.4	1.88	13	1.2	153.2	47	4.75	7.77	1.29	3.26
5	1758.8	1.88	17.5	1.2	153.2	47	4.75	7.77	1.29	3.26
6	1703.1	1.88	21.5	1.2	147.6	47	4.75	7.77	1.29	3.39
7	1625.8	1.88	25.5	1.2	139.9	47	4.75	7.77	1.29	3.57
8	1544.2	1.88	29.5	1.2	164.9	47	4.52	6.26	1.29	3.03
9	1907.8	9.71	1	1.2	209.9	47	4.52	6.26	1.29	2.38
10	1926.5	9.71	5	1.2	169.9	47	4.75	7.77	1.29	2.94
11	1965.2	9.71	9	1.2	173.8	47	4.75	7.77	1.29	2.88
12	2003.5	9.71	13	1.2	177.6	47	4.75	7.77	1.29	2.82
13	2003.1	9.71	17.5	1.2	177.5	47	4.75	7.77	1.29	2.82
14	1964.3	9.71	21.5	1.2	173.7	47	4.75	7.77	1.29	2.88
15	1925.5	9.71	25.5	1.2	169.8	47	4.75	7.77	1.29	2.94
16	1906.9	9.71	29.5	1.2	209.8	47	4.52	6.26	1.29	2.38
17	1857	17.54	1	1.2	203.6	47	4.52	6.26	1.29	2.46
18	1885.6	17.54	5	1.2	165.8	47	4.75	7.77	1.29	3.02
19	1926.9	17.54	9	1.2	169.9	47	4.75	7.77	1.29	2.94
20	1964.8	17.54	13	1.2	173.7	47	4.75	7.77	1.29	2.88
21	1964.7	17.54	17.5	1.2	173.7	47	4.75	7.77	1.29	2.88
22	1926.8	17.54	21.5	1.2	169.9	47	4.75	7.77	1.29	2.94
23	1885.7	17.54	25.5	1.2	165.8	47	4.75	7.77	1.29	3.02
24	1857.7	17.54	29.5	1.2	203.7	47	4.52	6.26	1.29	2.45

Tarut Bridge - Analysis and design of foundation

Node No.	Load value	X-coord.	Y-coord.	Pile diameter	Punching shear stress	Stress on the column	Area of critical section of punching shear	Perimeter of critical section of punching shear	Effective depth of the section of punching shear	Punching shear stress ratio
I [-]	Pc [kN]	Xc [m]	Yc [m]	a [m]	Qp [kN/m ²]	Qo [kN/m ²]	PA [m ²]	AL [m]	Dp [m]	Rpa [%]
25	1850.8	25.37	1	1.2	202.9	47	4.52	6.26	1.29	2.46
26	1877.4	25.37	5	1.2	165	47	4.75	7.77	1.29	3.03
27	1916.5	25.37	9	1.2	168.9	47	4.75	7.77	1.29	2.96
28	1952.5	25.37	13	1.2	172.5	47	4.75	7.77	1.29	2.9
29	1952.2	25.37	17.5	1.2	172.5	47	4.75	7.77	1.29	2.9
30	1915.8	25.37	21.5	1.2	168.8	47	4.75	7.77	1.29	2.96
31	1876.5	25.37	25.5	1.2	164.9	47	4.75	7.77	1.29	3.03
32	1850.1	25.37	29.5	1.2	202.8	47	4.52	6.26	1.29	2.47
33	1842.2	33.2	1	1.2	201.8	47	4.52	6.26	1.29	2.48
34	1862.8	33.2	5	1.2	163.5	47	4.75	7.77	1.29	3.06
35	1897.9	33.2	9	1.2	167	47	4.75	7.77	1.29	2.99
36	1932.1	33.2	13	1.2	170.5	47	4.75	7.77	1.29	2.93
37	1932	33.2	17.5	1.2	170.4	47	4.75	7.77	1.29	2.93
38	1897.7	33.2	21.5	1.2	167	47	4.75	7.77	1.29	2.99
39	1862.5	33.2	25.5	1.2	163.5	47	4.75	7.77	1.29	3.06
40	1841.9	33.2	29.5	1.2	201.8	47	4.52	6.26	1.29	2.48
41	2086.5	41.03	1	1.2	232	47	4.52	6.26	1.29	2.15
42	2008.6	41.03	5	1.2	178.1	47	4.75	7.77	1.29	2.81
43	1992.4	41.03	9	1.2	176.5	47	4.75	7.77	1.29	2.83
44	2005.8	41.03	13	1.2	177.8	47	4.75	7.77	1.29	2.81
45	2006.3	41.03	17.5	1.2	177.9	47	4.75	7.77	1.29	2.81
46	1993.8	41.03	21.5	1.2	176.6	47	4.75	7.77	1.29	2.83
47	2010.8	41.03	25.5	1.2	178.3	47	4.75	7.77	1.29	2.8
48	2089.9	41.03	29.5	1.2	232.5	47	4.52	6.26	1.29	2.15
49	2649.7	49.91	1	1.2	281.7	56.2	5.38	5.14	1.62	1.77
Node	Load	X-coord.	Y-coord.	Pile	Punching	Stress	Area of	Perimeter	Effective	Punching

Tarut Bridge - Analysis and design of foundation

No.	value			diameter	shear stress	on the column	critical section of punching shear	of critical section of punching shear	depth of the section of punching shear	shear stress ratio
I [-]	Pc [kN]	Xc [m]	Yc [m]	a [m]	Qp [kN/m ²]	Qo [kN/m ²]	PA [m ²]	AL [m]	Dp [m]	Rpa [%]
50	2523.1	47.41	1	1.2	56.7	75.5	11.69	8.99	3.22	8.83
51	2257.6	47.41	5	1.2	24.8	77.3	14.95	13.8	3.22	20.17
52	2435.7	49.91	5	1.2	177.1	56.2	5.9	7.33	1.62	2.82
53	2183.9	47.41	9	1.2	23.1	77.3	14.95	13.8	3.22	21.62
54	2389.6	49.91	9	1.2	173.3	56.2	5.9	7.33	1.62	2.89
55	2184.8	47.41	13	1.2	23.1	77.3	14.95	13.8	3.22	21.6
56	2404.6	49.91	13	1.2	174.5	56.2	5.9	7.33	1.62	2.86
57	2185.3	47.41	17.5	1.2	23.2	77.3	14.95	13.8	3.22	21.59
58	2405.2	49.91	17.5	1.2	174.6	56.2	5.9	7.33	1.62	2.86
59	2185.8	47.41	21.5	1.2	23.2	77.3	14.95	13.8	3.22	21.58
60	2391.9	49.91	21.5	1.2	173.5	56.2	5.9	7.33	1.62	2.88
61	2261.6	47.41	25.5	1.2	24.9	77.3	14.95	13.8	3.22	20.1
62	2440.4	49.91	25.5	1.2	177.5	56.2	5.9	7.33	1.62	2.82
63	2530	47.41	29.5	1.2	56.9	75.5	11.69	8.99	3.22	8.79
64	2657.7	49.91	29.5	1.2	282.7	56.2	5.38	5.14	1.62	1.77

Tarut Bridge - Analysis and design of foundation

Method (2)
Modulus of subgrade reaction is defined by the user

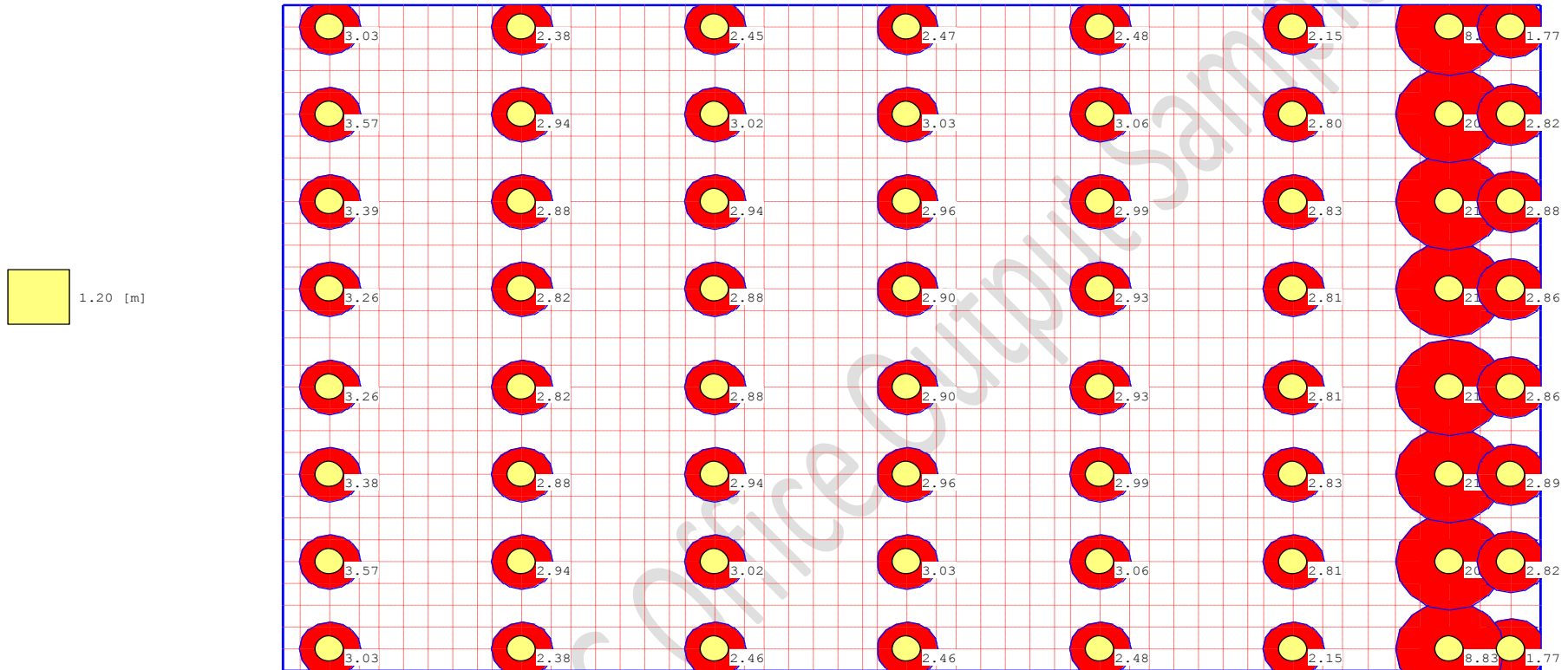

Punching shear stress ratio R_{pa} [%]
Max. R_{pa} = 21.62 at column 53, Min. R_{pa} = 1.77 at column 64

GEOTEC Software P. O. Box 465, Port-Said, Egypt* Tel. +2066-3609247	
Scale 1:250 File: Pile cap design Page No.:	Title: Pile foundation design-left side Date: 25/09/2010 Project: Tarut bridge, Qatif city- Saudi Arabia

Tarut Bridge - Analysis and design of foundation

Method (2)

Modulus of subgrade reaction is defined by the user

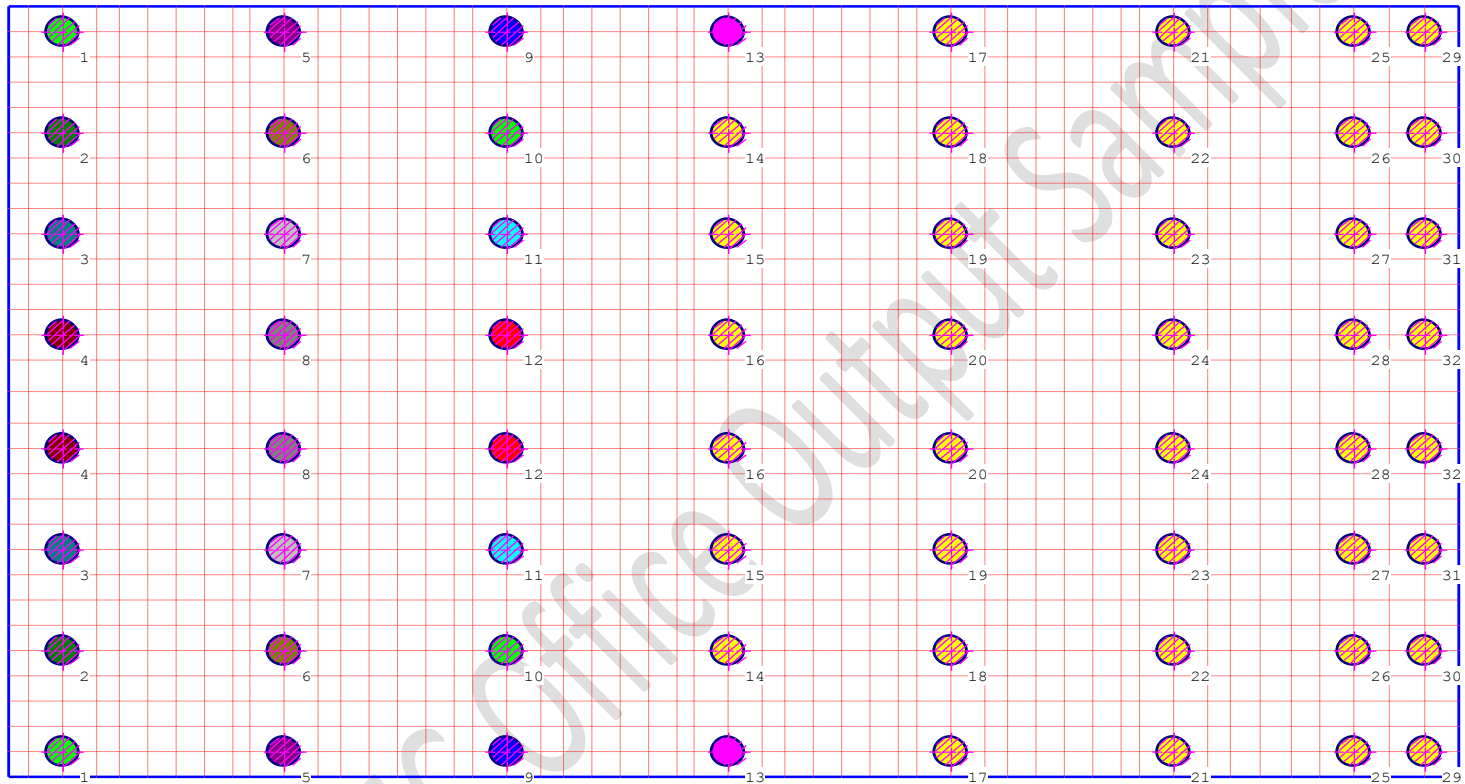

Pile locations and groups

No. of pile groups = 32

GEOTEC Software

P. O. Box 465, Port-Said, Egypt* Tel. +2066-3609247

Scale 1:250

Title: Pile foundation design-left side

File: Pile cap design

Date: 25/09/2010

Page No.:

Project: Tarut bridge, Qatif city- Saudi Arabia

Tarut Bridge - Analysis and design of foundation

Method (2)
 Modulus of subgrade reaction is defined by the user

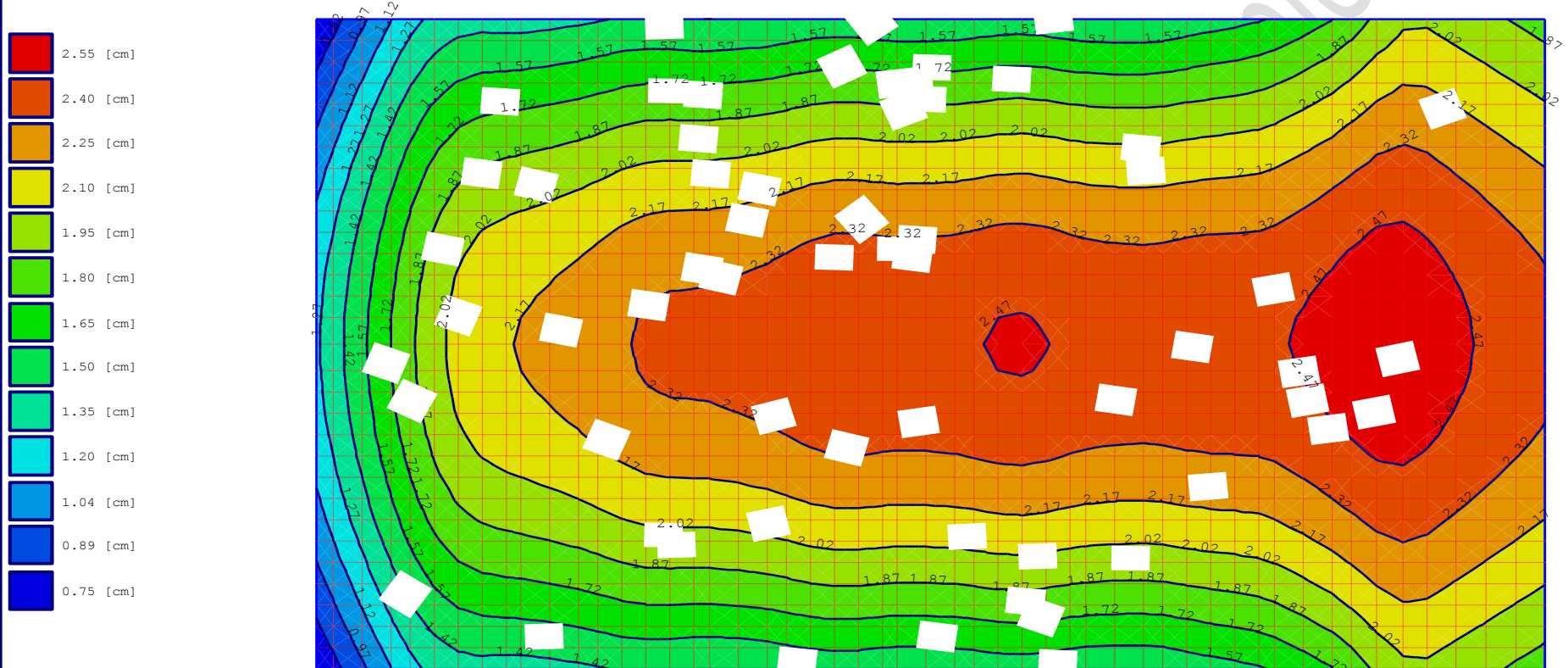

Settlements [cm]
 Max. $s = 2.57$ at node 907, Min. $s = 0.67$ at node 4

GEOTEC Software P. O. Box 465, Port-Said, Egypt* Tel. +2066-3609247	
Scale 1:250	Title: Pile foundation design-left side
File: Pile cap design	Date: 25/09/2010
Page No.:	Project: Tarut bridge, Qatif city- Saudi Arabia

Tarut Bridge - Analysis and design of foundation

Method (2)
Modulus of subgrade reaction is defined by the user

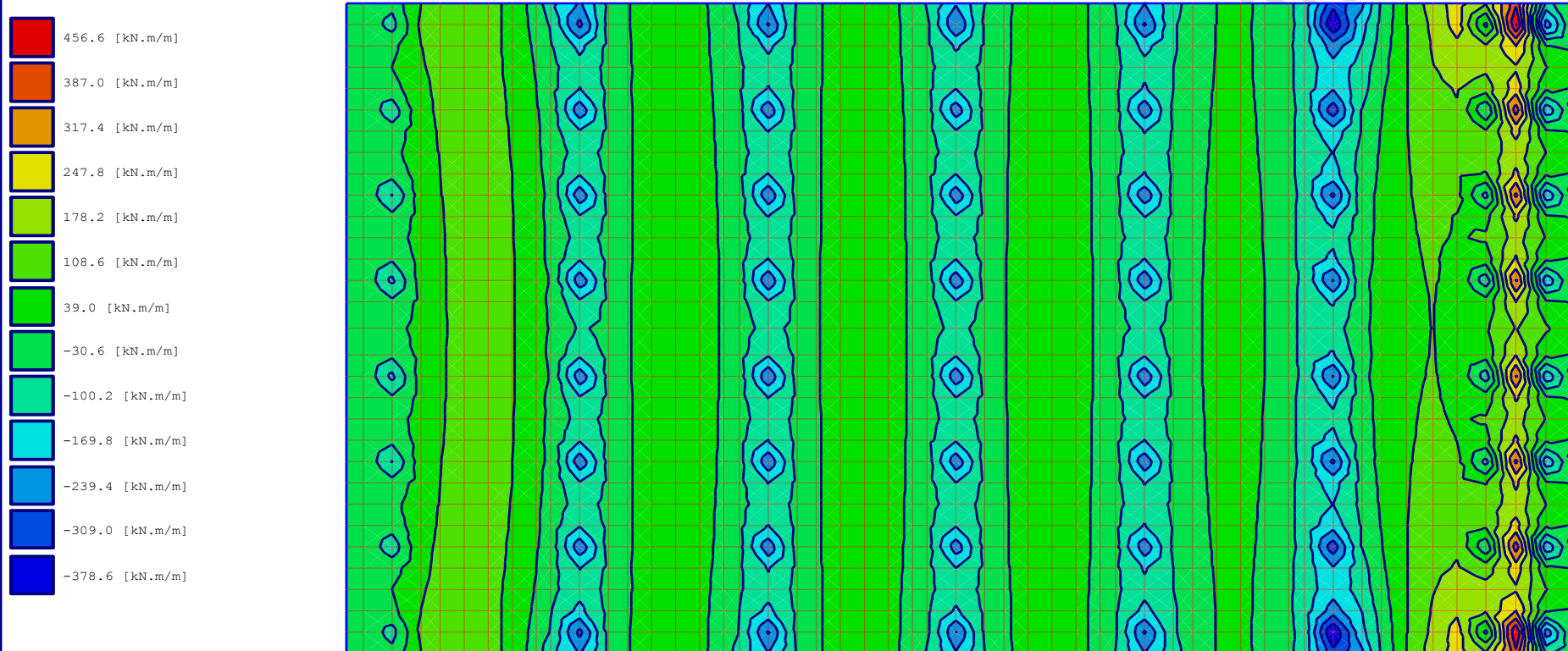

Moments m_x [kN.m/m]
Max. m_x = 491.8 at node 1611, Min. m_x = -413.4 at node 1604

GEOTEC Software

P. O. Box 465, Port-Said, Egypt* Tel. +2066-3609247

Scale 1:250

File: Pile cap design

Page No.:

Title: Pile foundation design-left side

Date: 25/09/2010

Project: Tarut bridge, Qatif city- Saudi Arabia

Tarut Bridge - Analysis and design of foundation

Method (2)
Modulus of subgrade reaction is defined by the user

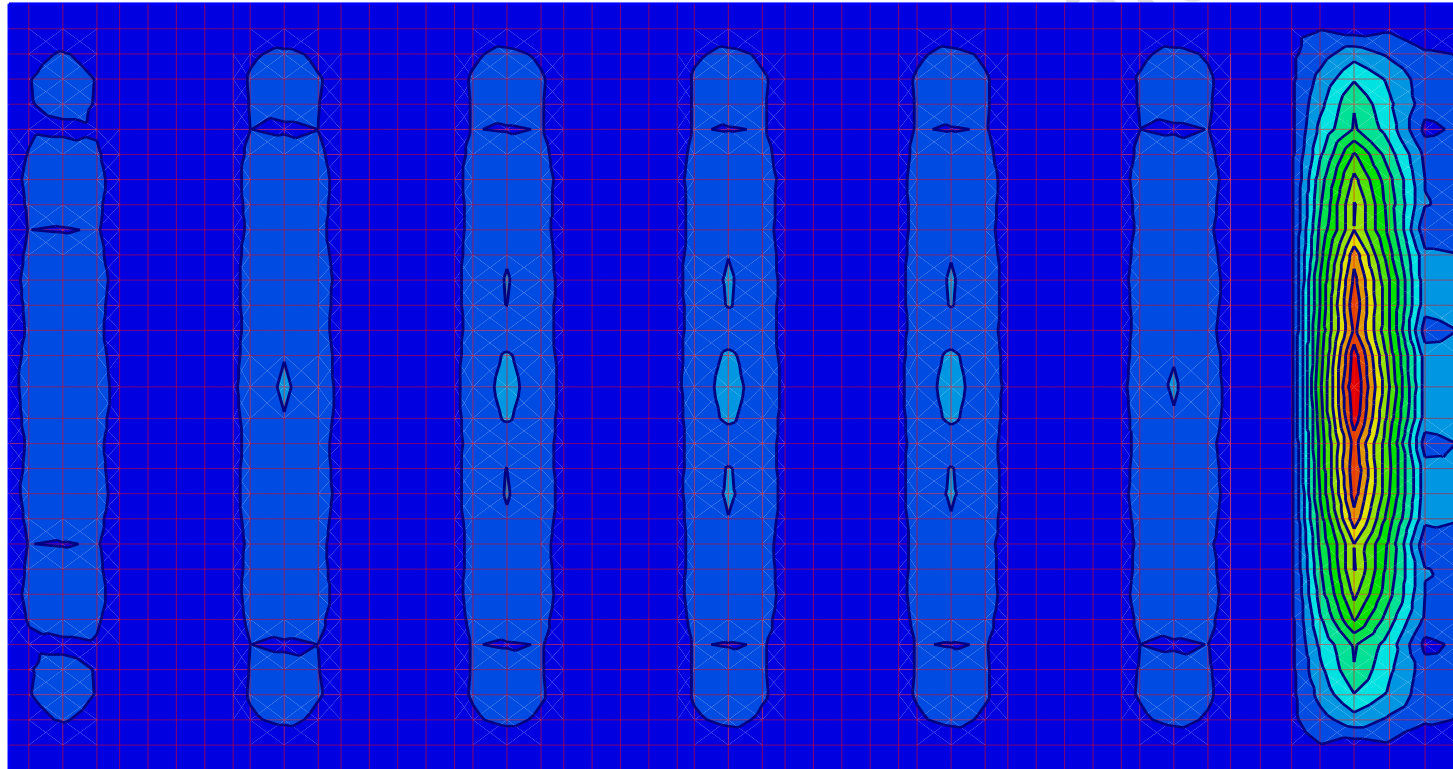
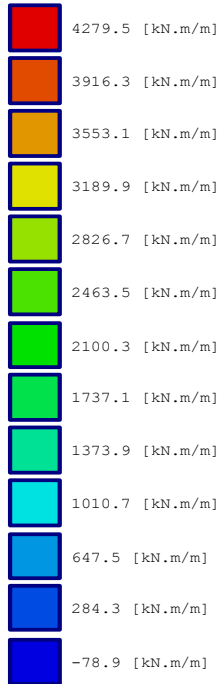

Moments m_y [kN.m/m]
Max. m_y = 4461.0 at node 910, Min. m_y = -260.5 at node 1612

GEOTEC Software

P. O. Box 465, Port-Said, Egypt* Tel. +2066-3609247

Scale 1:250

File: Pile cap design

Page No.:

Title: Pile foundation design-left side

Date: 25/09/2010

Project: Tarut bridge, Qatif city- Saudi Arabia

Tarut Bridge - Analysis and design of foundation

Method (2)
Modulus of subgrade reaction is defined by the user

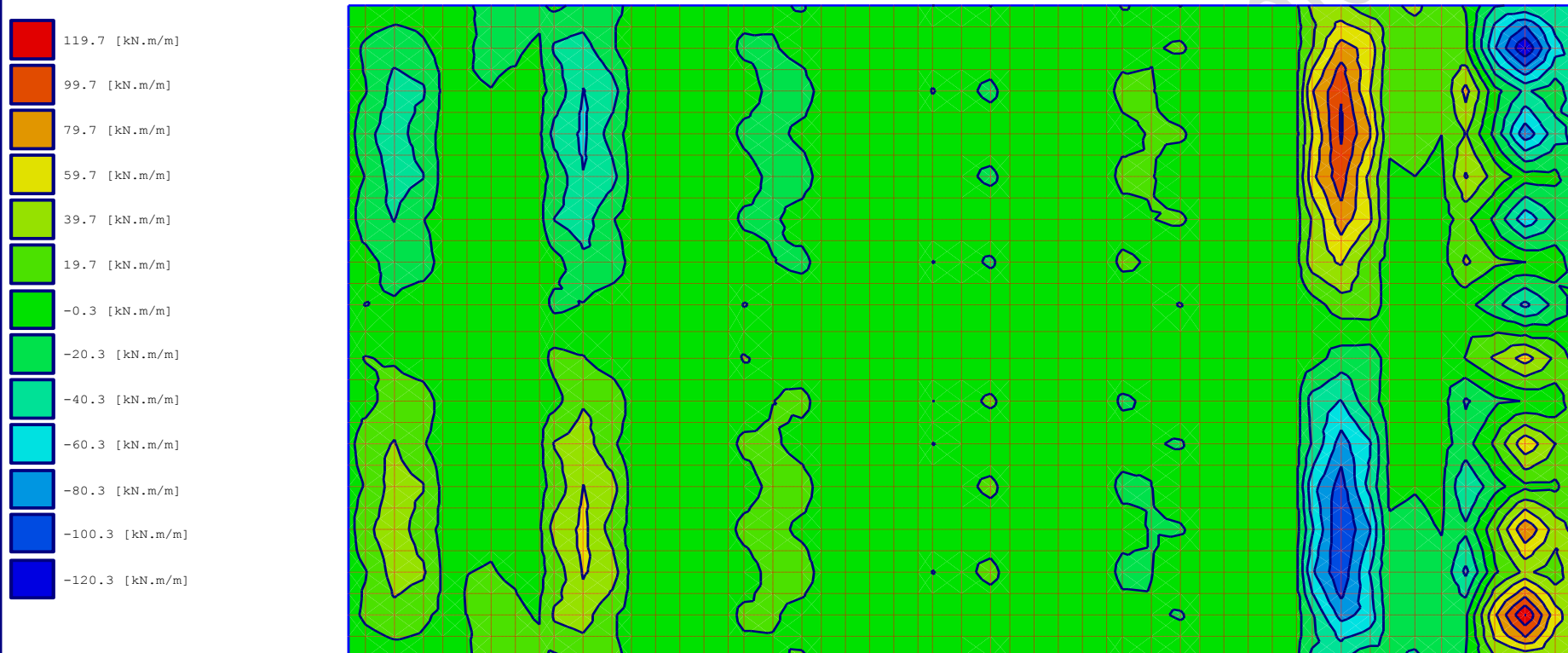

Moments m_{xy} [kN.m/m]
Max. m_{xy} = 130.0 at node 261, Min. m_{xy} = -130.3 at node 1561

GEOTEC Software

P. O. Box 465, Port-Said, Egypt* Tel. +2066-3609247

Scale 1:250

File: Pile cap design

Page No.:

Title: Pile foundation design-left side

Date: 25/09/2010

Project: Tarut bridge, Qatif city- Saudi Arabia

Tarut Bridge - Analysis and design of foundation

Method (2)
Modulus of subgrade reaction is defined by the user

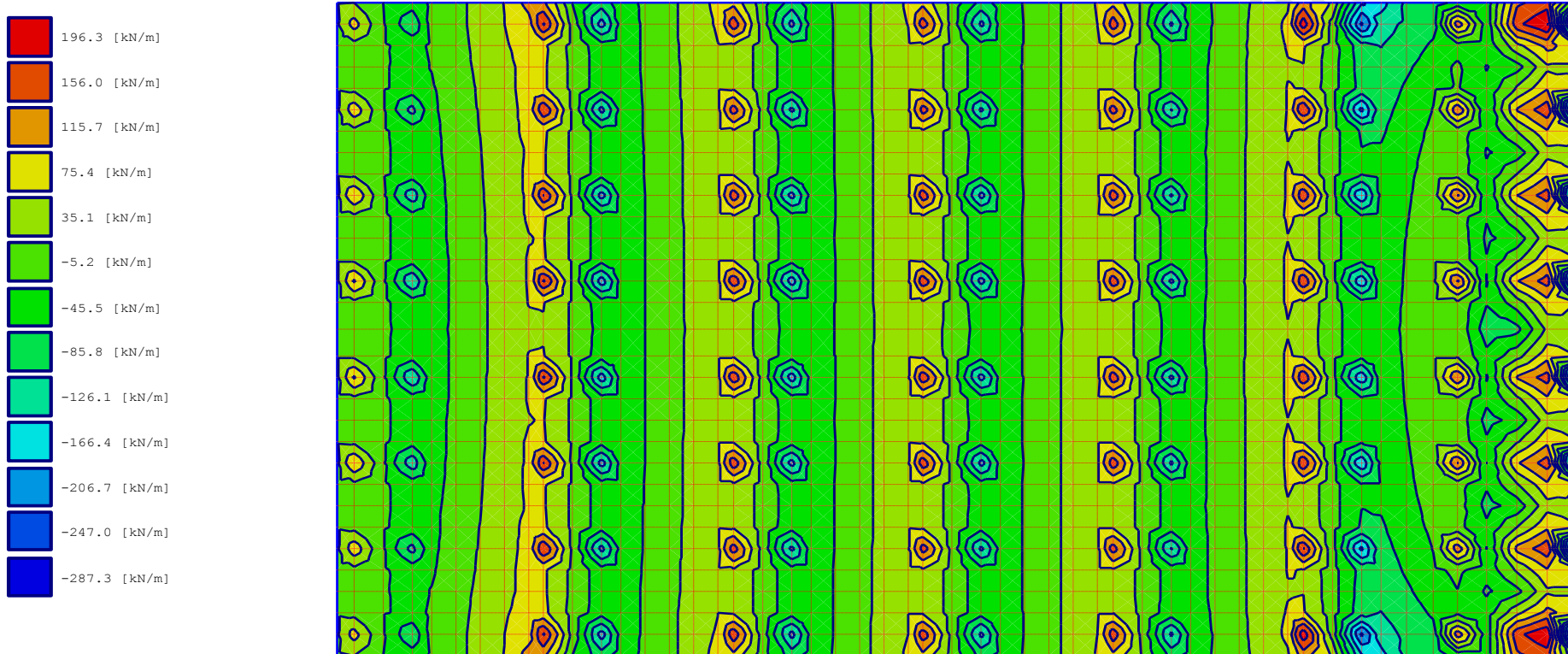

Shear forces Q_x [kN/m]
Max. $Q_x = 216.8$ at node 1612, Min. $Q_x = -307.4$ at node 83

GEOTEC Software

P. O. Box 465, Port-Said, Egypt* Tel. +2066-3609247

Scale 1:250

File: Pile cap design

Page No.:

Title: Pile foundation design-left side

Date: 25/09/2010

Project: Tarut bridge, Qatif city- Saudi Arabia

Tarut Bridge - Analysis and design of foundation

Method (2)
Modulus of subgrade reaction is defined by the user

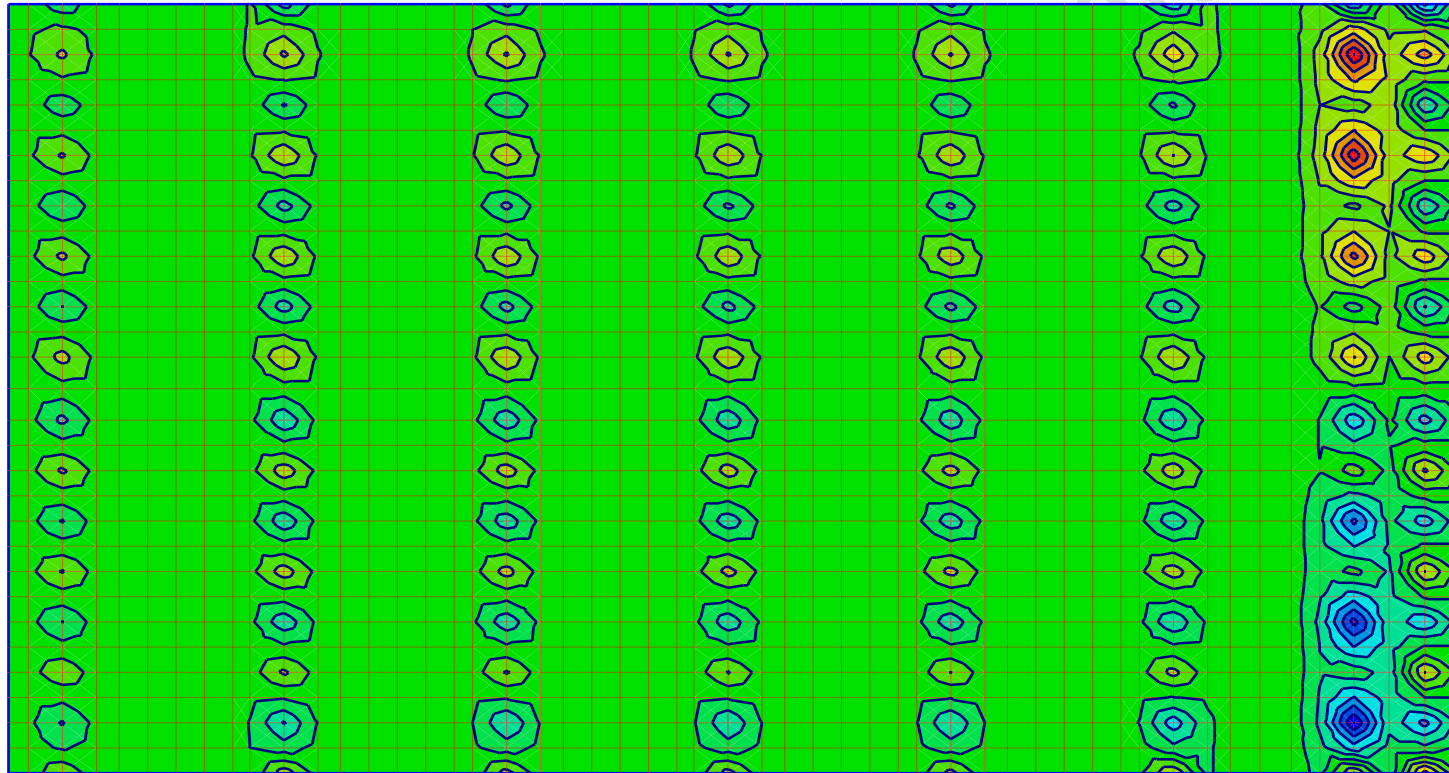
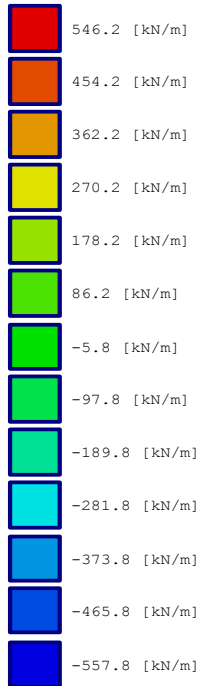

Shear forces Q_y [kN/m]
Max. $Q_y = 592.4$ at node 1560, Min. $Q_y = -603.8$ at node 260

GEOTEC Software

P. O. Box 465, Port-Said, Egypt* Tel. +2066-3609247

Scale 1:250

File: Pile cap design

Page No.:

Title: Pile foundation design-left side

Date: 25/09/2010

Project: Tarut bridge, Qatif city- Saudi Arabia

Tarut Bridge - Analysis and design of foundation

Method (2)
Modulus of subgrade reaction is defined by the user

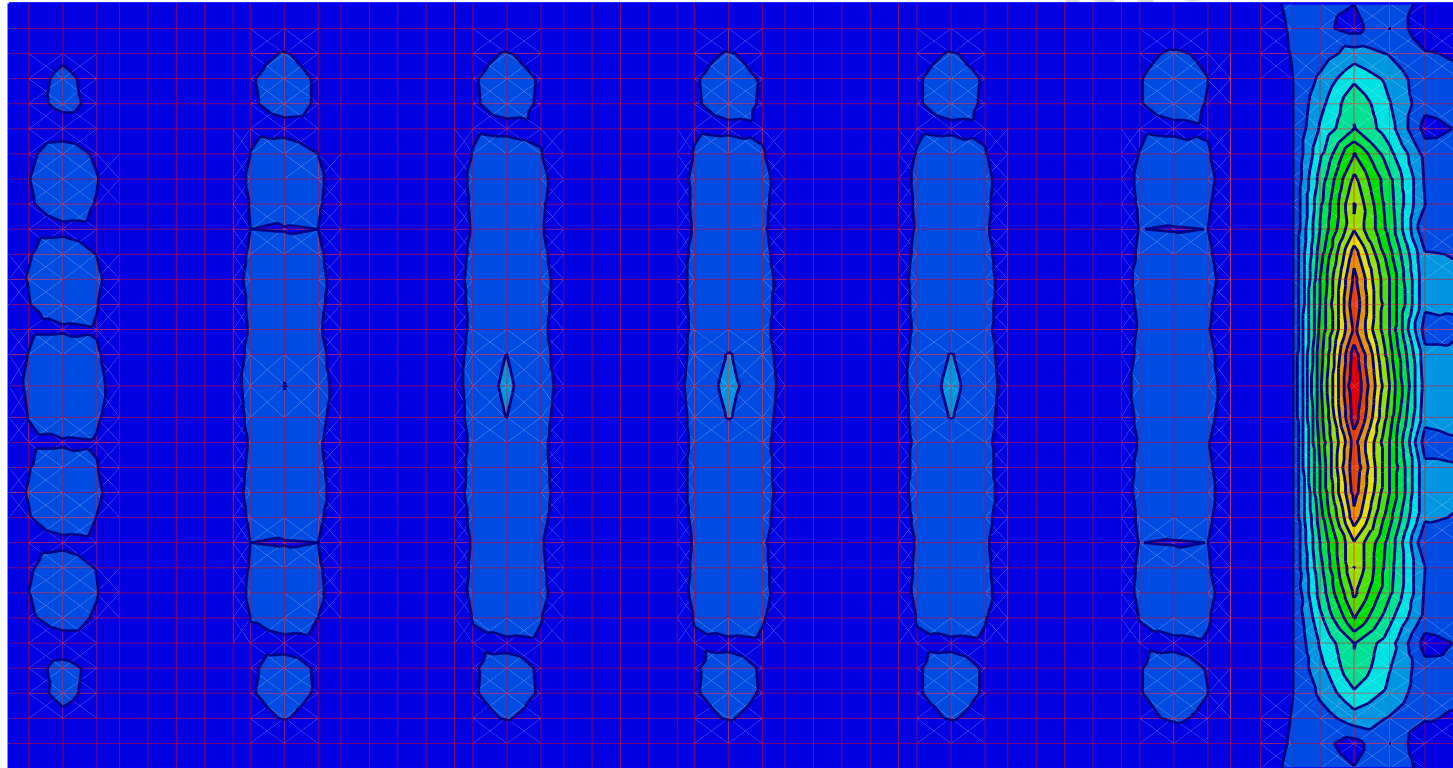
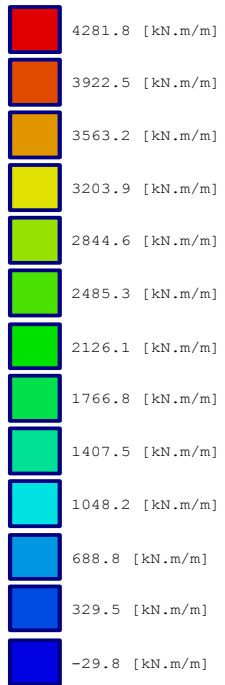

Principal moments h_1 [kN.m/m]
Max. $h_1 = 4461.0$ at node 910, Min. $h_1 = -209.4$ at node 1612

GEOTEC Software

P. O. Box 465, Port-Said, Egypt* Tel. +2066-3609247

Scale 1:250

File: Pile cap design

Page No.:

Title: Pile foundation design-left side

Date: 25/09/2010

Project: Tarut bridge, Qatif city- Saudi Arabia

Tarut Bridge - Analysis and design of foundation

Method (2)
Modulus of subgrade reaction is defined by the user

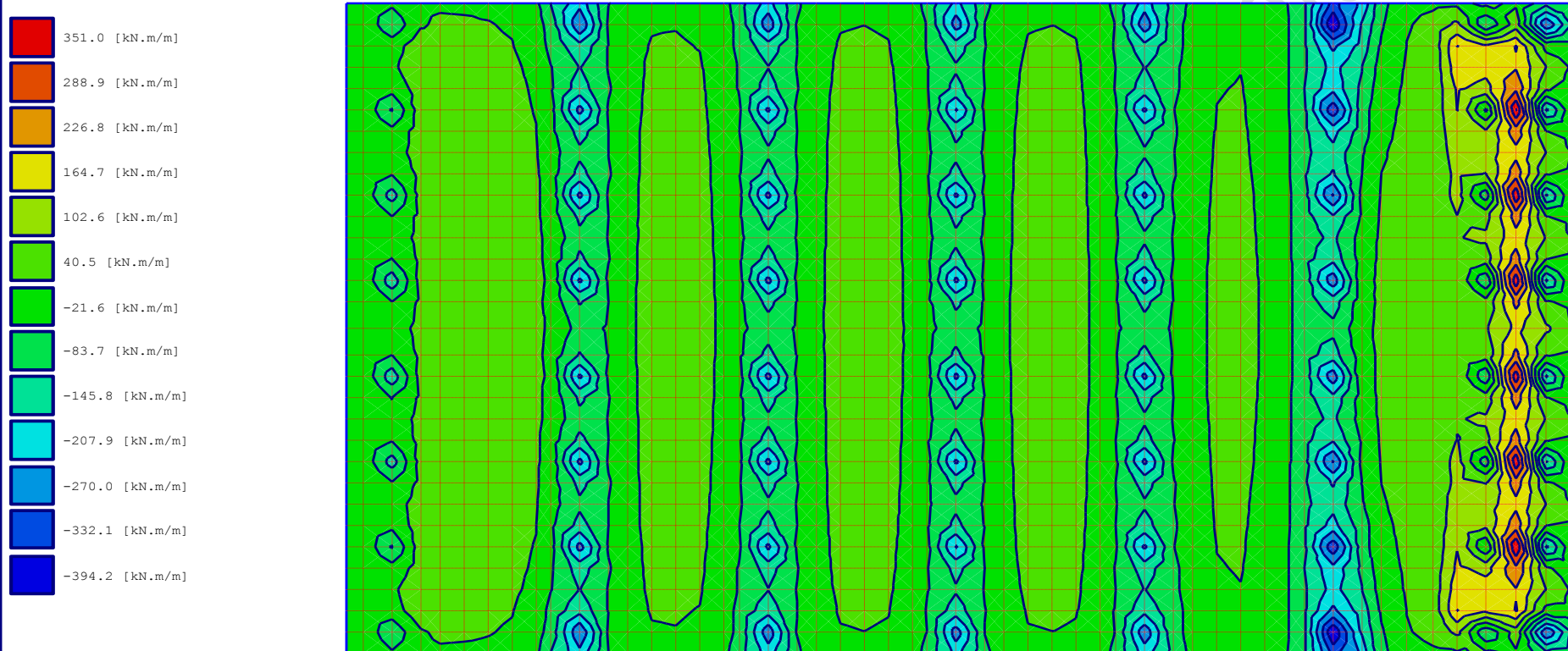

Principal moments hm_2 [kN.m/m]
Max. hm_2 = 382.4 at node 1411, Min. hm_2 = -425.2 at node 1604

GEOTEC Software

P. O. Box 465, Port-Said, Egypt* Tel. +2066-3609247

Scale 1:250

File: Pile cap design

Page No.:

Title: Pile foundation design-left side

Date: 25/09/2010

Project: Tarut bridge, Qatif city- Saudi Arabia

Tarut Bridge - Analysis and design of foundation

Method (2)
Modulus of subgrade reaction is defined by the user

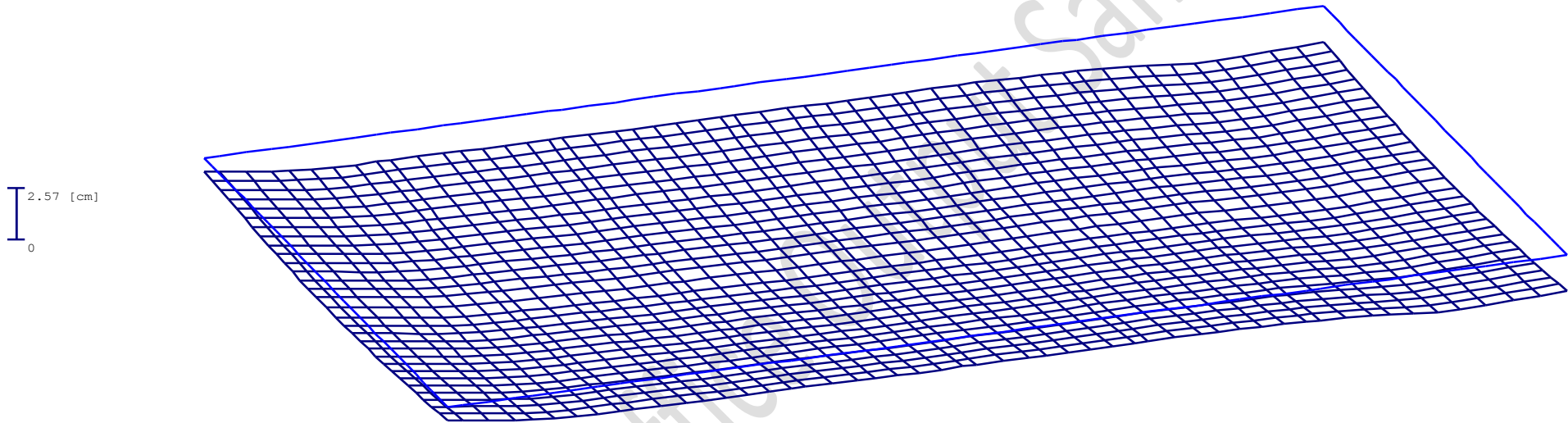

Slab deformation w [cm]
Max. $w = 2.57$ at node 907, Min. $w = 0.67$ at node 4

GEOTEC Software

P. O. Box 465, Port-Said, Egypt* Tel. +2066-3609247

Scale factor: 250

Title: Pile foundation design-left side

File: Pile cap design

Date: 25/09/2010

Page No.:

Project: Tarut bridge, Qatif city- Saudi Arabia

Tarut Bridge - Analysis and design of foundation

Method (2)
 Modulus of subgrade reaction is defined by the user

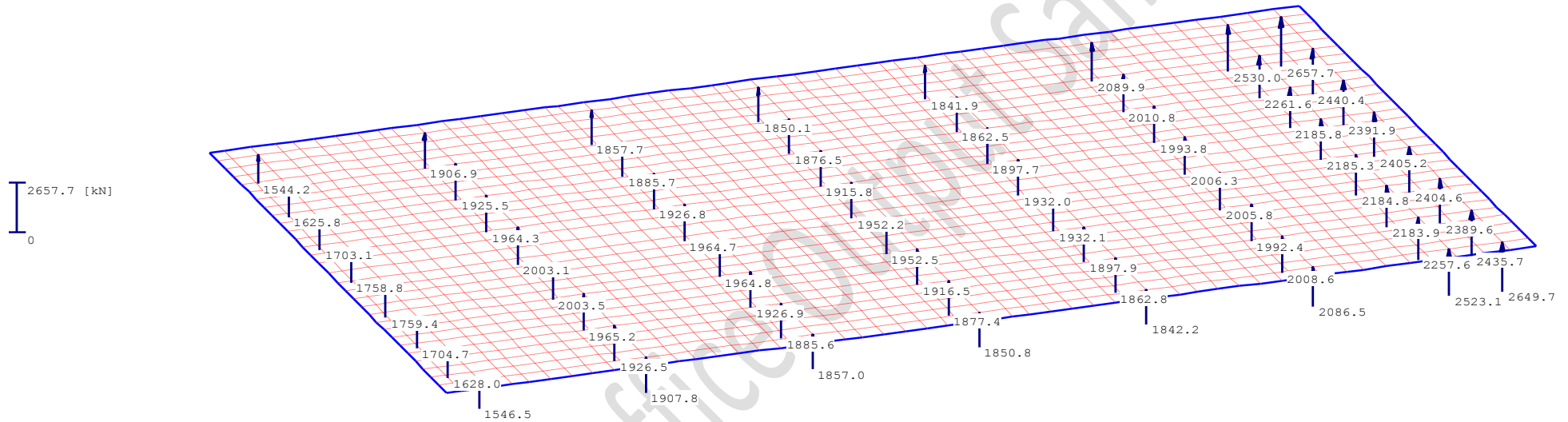

Support reactions V [kN]
 Max. V = 2657.7 at node 1612, Min. V = 1544.2 at node 1564, Sum = 128684.4

GEOTEC Software

P. O. Box 465, Port-Said, Egypt* Tel. +2066-3609247

Scale factor: 250

File: Pile cap design

Page No.:

Title: Pile foundation design-left side

Date: 25/09/2010

Project: Tarut bridge, Qatif city- Saudi Arabia

Tarut Bridge - Analysis and design of foundation



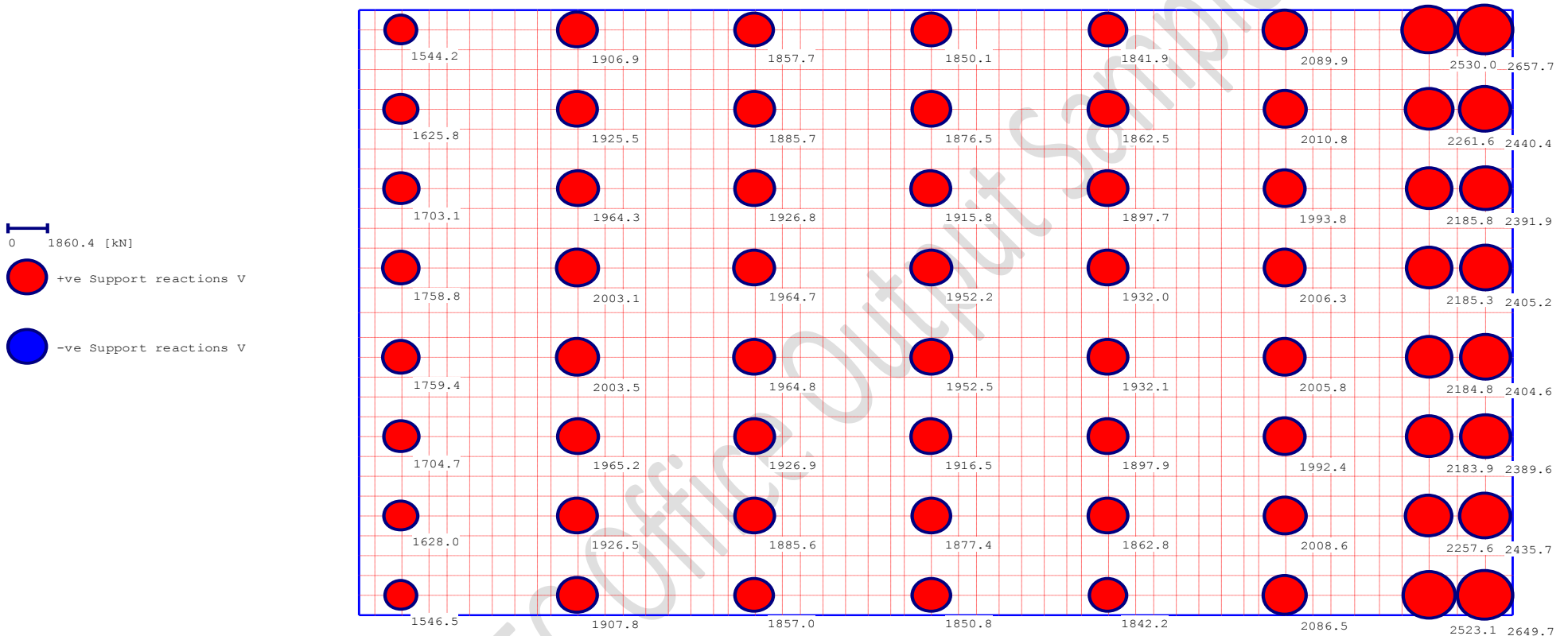











Method (2)
Modulus of subgrade reaction is defined by the user



Support reactions V [kN]
Max. V = 2657.7 at node 1612, Min. V = 1544.2 at node 1564, Sum = 128684.4

GEOTEC Software P. O. Box 465, Port-Said, Egypt* Tel. +2066-3609247	
Scale 1:250 File: Pile cap design Page No.:	Title: Pile foundation design-left side Date: 25/09/2010 Project: Tarut bridge, Qatif city- Saudi Arabia

Tarut Bridge - Analysis and design of foundation

-  Group 1
-  Group 2
-  Group 3
-  Group 4
-  Group 5
-  Group 6
-  Group 7
-  Group 8
-  Group 9
-  Group 10
-  Group 11
-  Group 12
-  Group 13
-  Group >= 14

Method (2)
Modulus of subgrade reaction is defined by the user

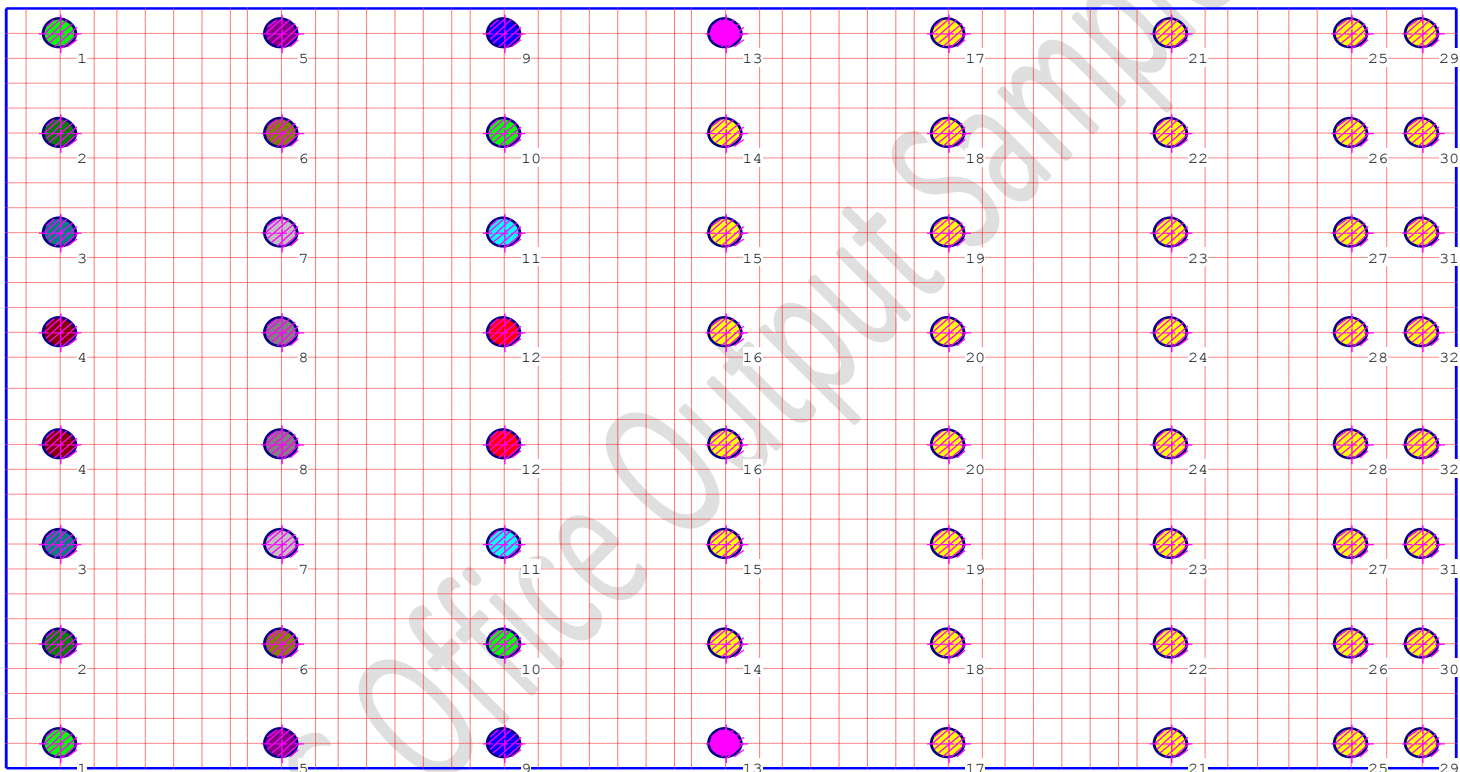

File locations and groups
No. of pile groups = 32

GEOTEC Software P. O. Box 465, Port-Said, Egypt* Tel. +2066-3609247	
Scale 1:250 File: Pile cap design Page No.:	Title: Pile foundation design-left side Date: 25/09/2010 Project: Tarut bridge, Qatif city- Saudi Arabia

Tarut Bridge - Analysis and design of foundation

Method (2)
Modulus of subgrade reaction is defined by the user

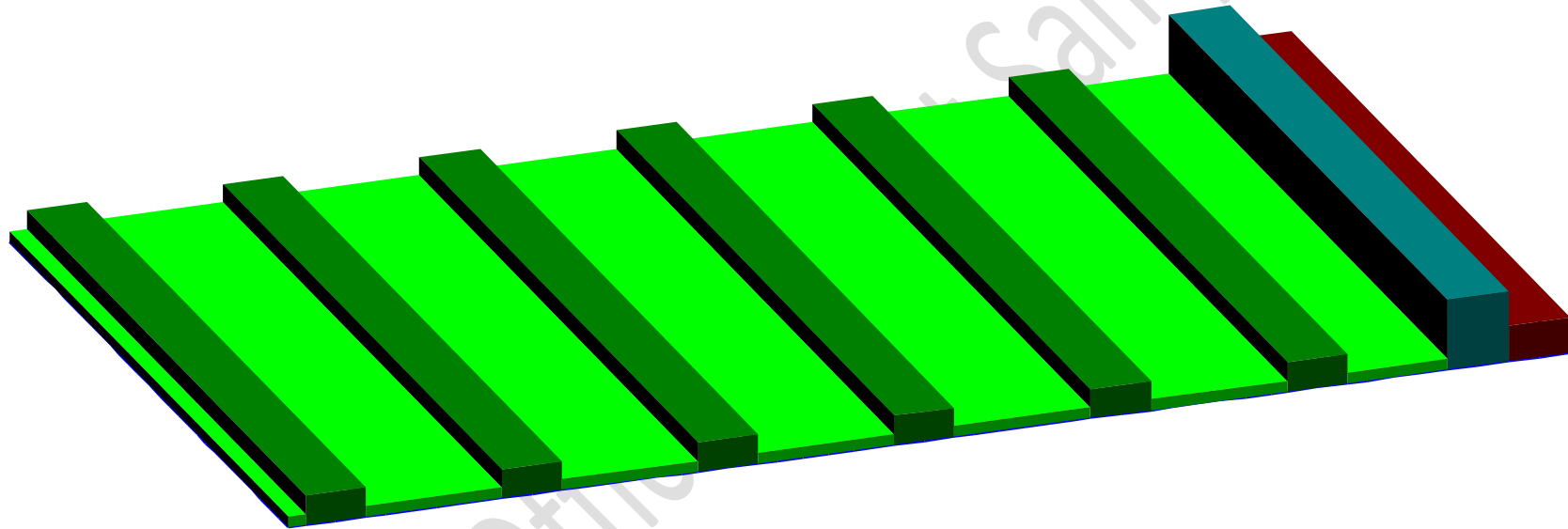
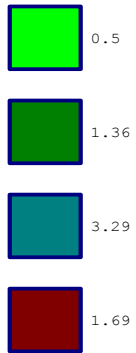

Slab thickness [m]
No. of element groups = 4

GEOTEC Software

P. O. Box 465, Port-Said, Egypt* Tel. +2066-3609247

Scale factor: 250

Title: Pile foundation design-left side

File: Pile cap design

Date: 25/09/2010

Page No.:

Project: Tarut bridge, Qatif city- Saudi Arabia

Tarut Bridge - Analysis and design of foundation

Method (2)

Modulus of subgrade reaction is defined by the user

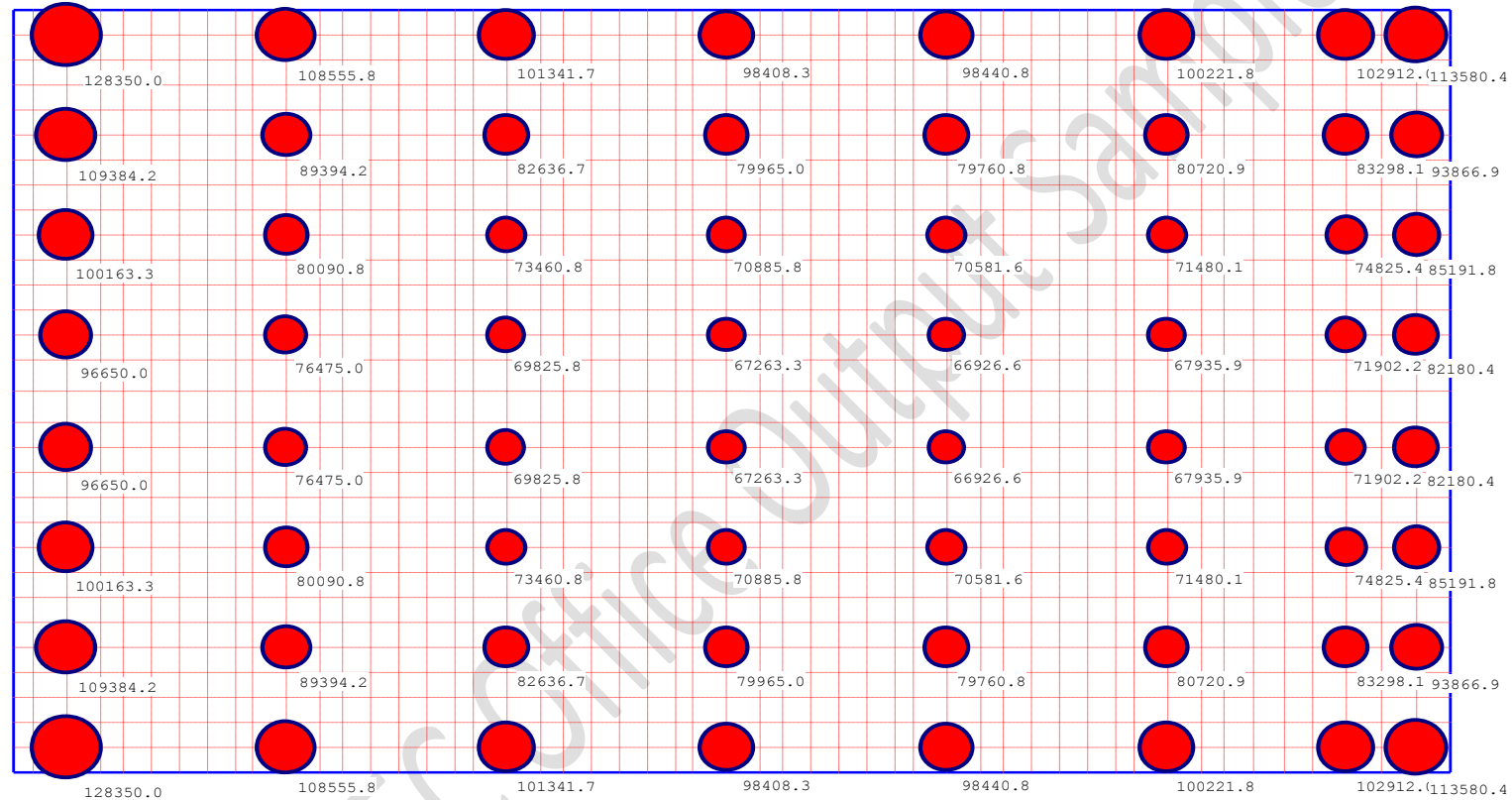

Modulus of subgrade reaction k_s [kN/m³]

Max. k_s = 128350.0 at node 164, Min. k_s = 0.0 at node 1

GEOTEC Software

P. O. Box 465, Port-Said, Egypt* Tel. +2066-3609247

Scale 1:250

File: Pile cap design

Page No.:

Title: Pile foundation design-left side

Date: 25/09/2010

Project: Tarut bridge, Qatif city- Saudi Arabia

Tarut Bridge - Analysis and design of foundation

Method (2)
Modulus of subgrade reaction is defined by the user

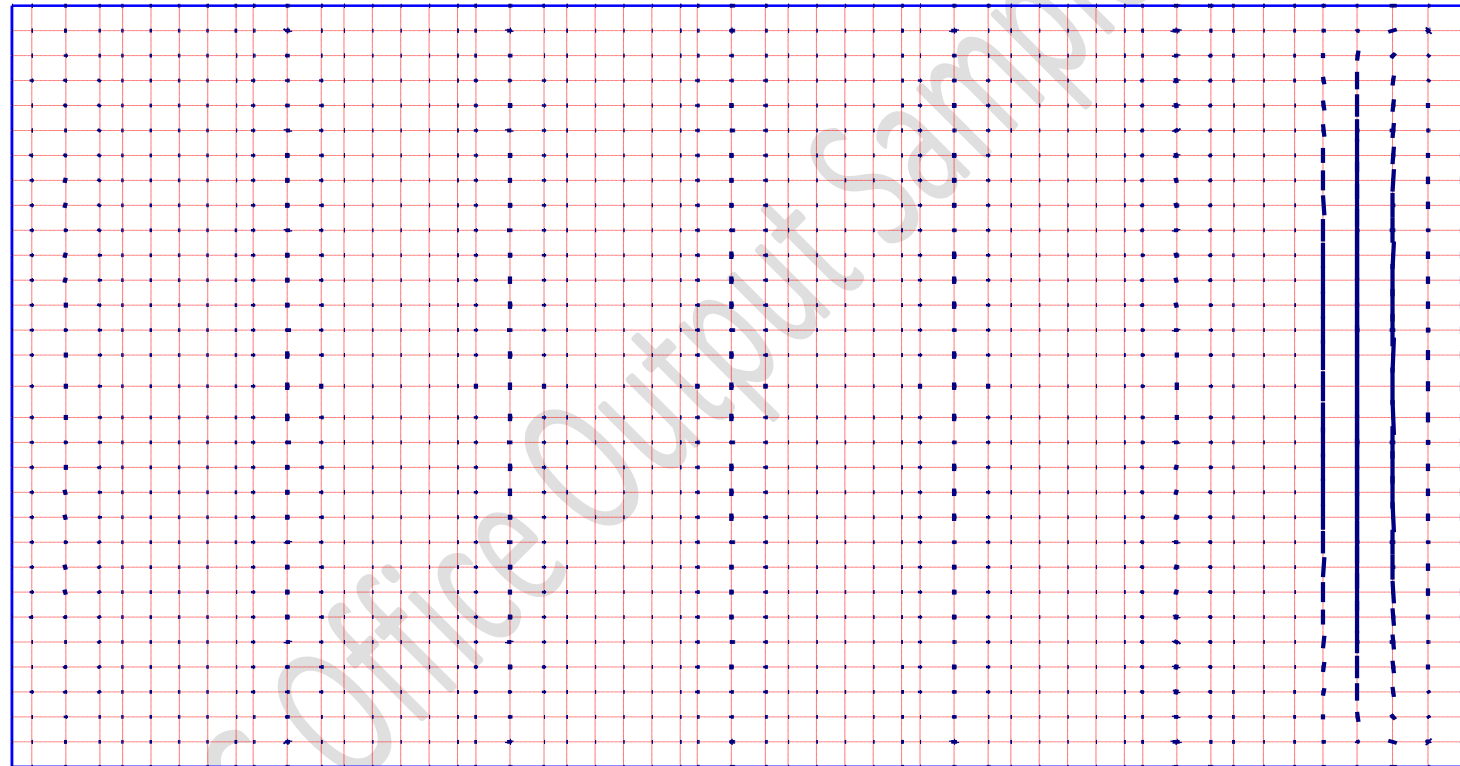
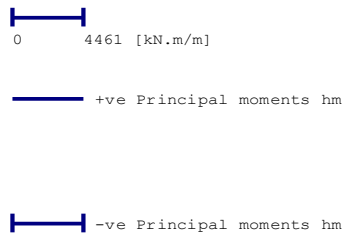

Principal moments hm [kN.m/m]
Max. hm = 4461.0 at node 910, Min. hm = -425.2 at node 1604

GEOTEC Software

P. O. Box 465, Port-Said, Egypt* Tel. +2066-3609247

Scale 1:250

File: Pile cap design

Page No.:

Title: Pile foundation design-left side

Date: 25/09/2010

Project: Tarut bridge, Qatif city- Saudi Arabia

Tarut Bridge - Analysis and design of foundation

Method (2)
Modulus of subgrade reaction is defined by the user

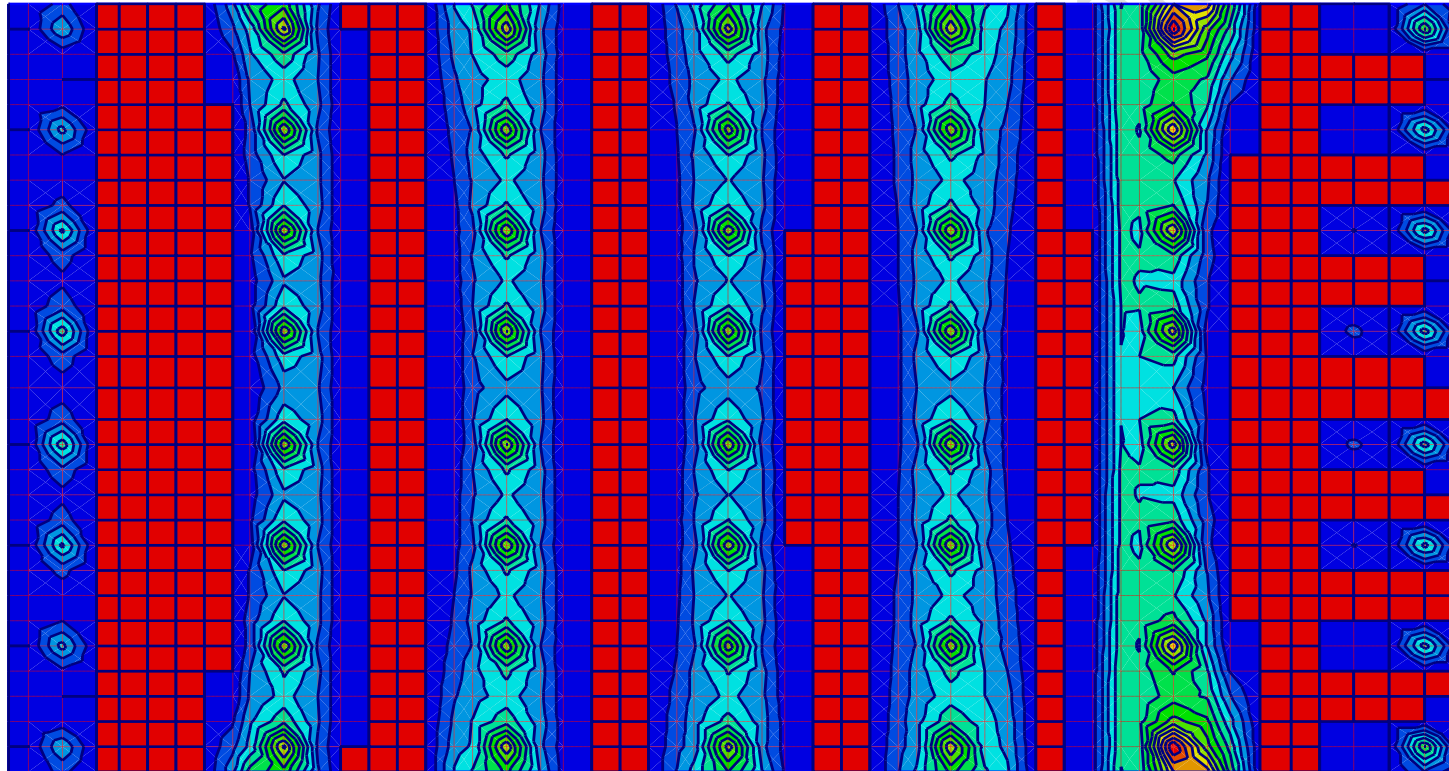
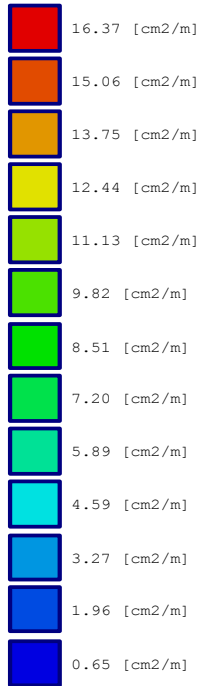

Top reinforcement in x-direction A_{s_topx} [cm2/m]
Max. A_{s_topx} = 17.07 at node 1604, Min. A_{s_topx} = 0.00 at node 74

GEOTEC Software

P. O. Box 465, Port-Said, Egypt* Tel. +2066-3609247

Scale 1:250

File: Pile cap design

Page No.:

Title: Pile foundation design-left side

Date: 25/09/2010

Project: Tarut bridge, Qatif city- Saudi Arabia

Tarut Bridge - Analysis and design of foundation

Method (2)

Modulus of subgrade reaction is defined by the user

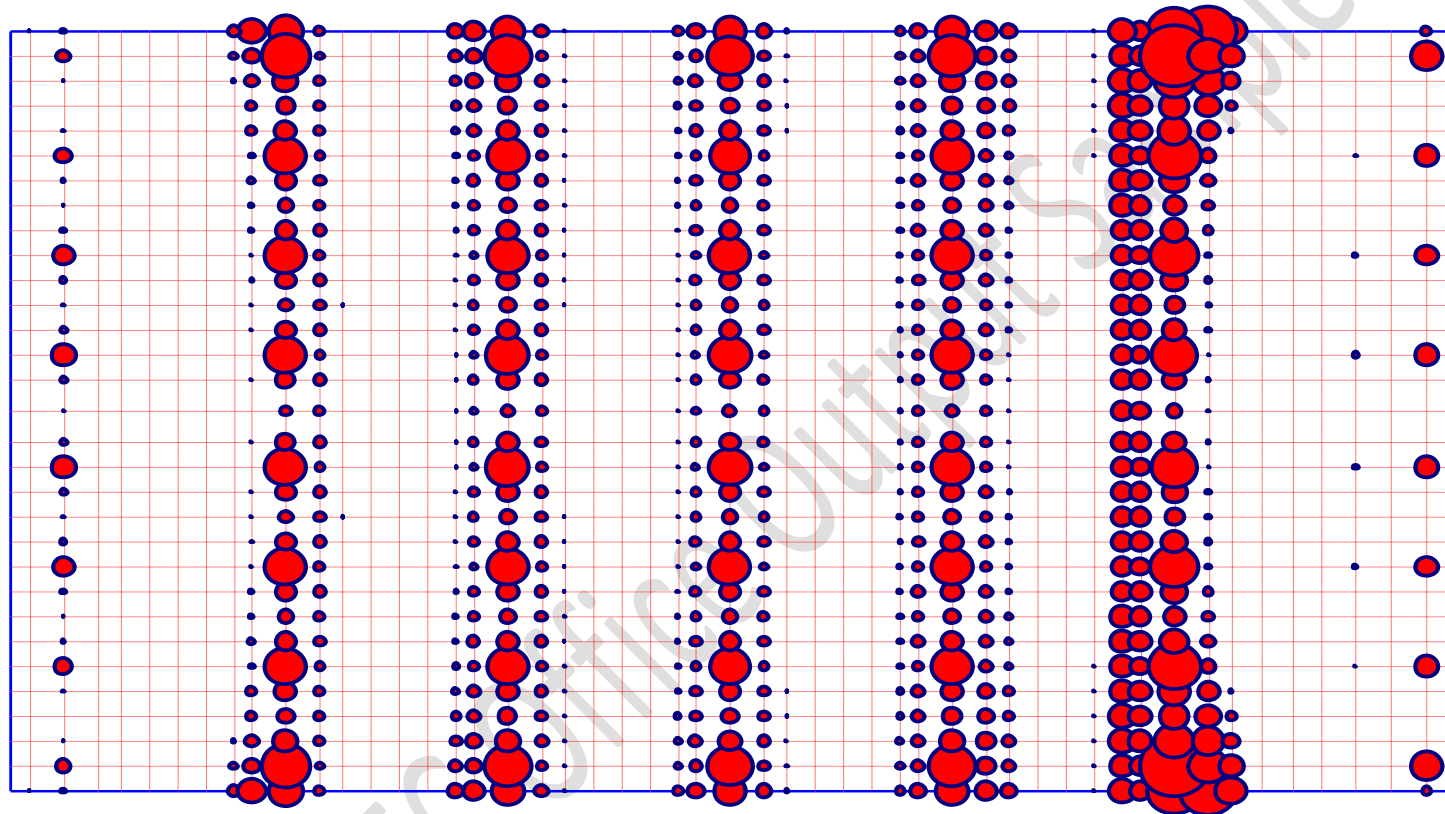

Top reinforcement in x-direction A_{s_topx} [cm²/m]

Max. A_{s_topx} = 17.07 at node 1604, Min. A_{s_topx} = 0.00 at node 74

GEOTEC Software

P. O. Box 465, Port-Said, Egypt* Tel. +2066-3609247

Scale 1:250

Title: Pile foundation design-left side

File: Pile cap design

Date: 25/09/2010

Page No.:

Project: Tarut bridge, Qatif city- Saudi Arabia

Tarut Bridge - Analysis and design of foundation

Method (2)
Modulus of subgrade reaction is defined by the user

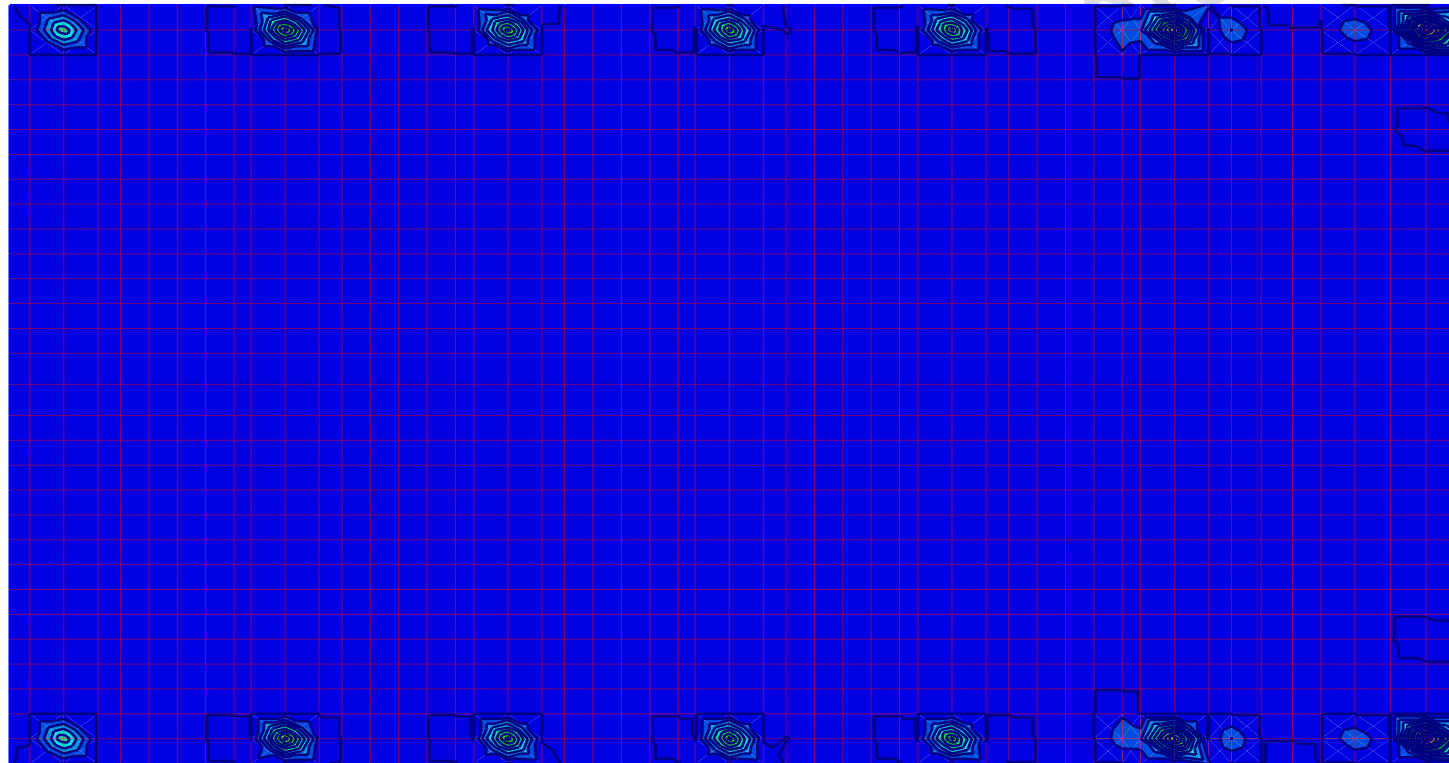
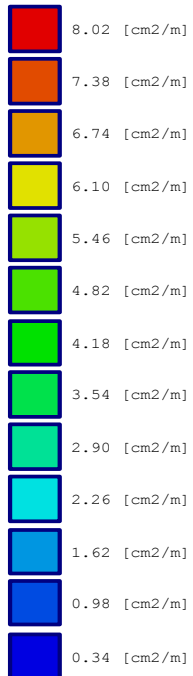

Top reinforcement in y-direction A_{s_topy} [cm2/m]
Max. A_{s_topy} = 8.33 at node 1612, Min. A_{s_topy} = 0.02 at node 190

GEOTEC Software

P. O. Box 465, Port-Said, Egypt* Tel. +2066-3609247

Scale 1:250

File: Pile cap design

Page No.:

Title: Pile foundation design-left side

Date: 25/09/2010

Project: Tarut bridge, Qatif city- Saudi Arabia

Tarut Bridge - Analysis and design of foundation

Method (2)
Modulus of subgrade reaction is defined by the user

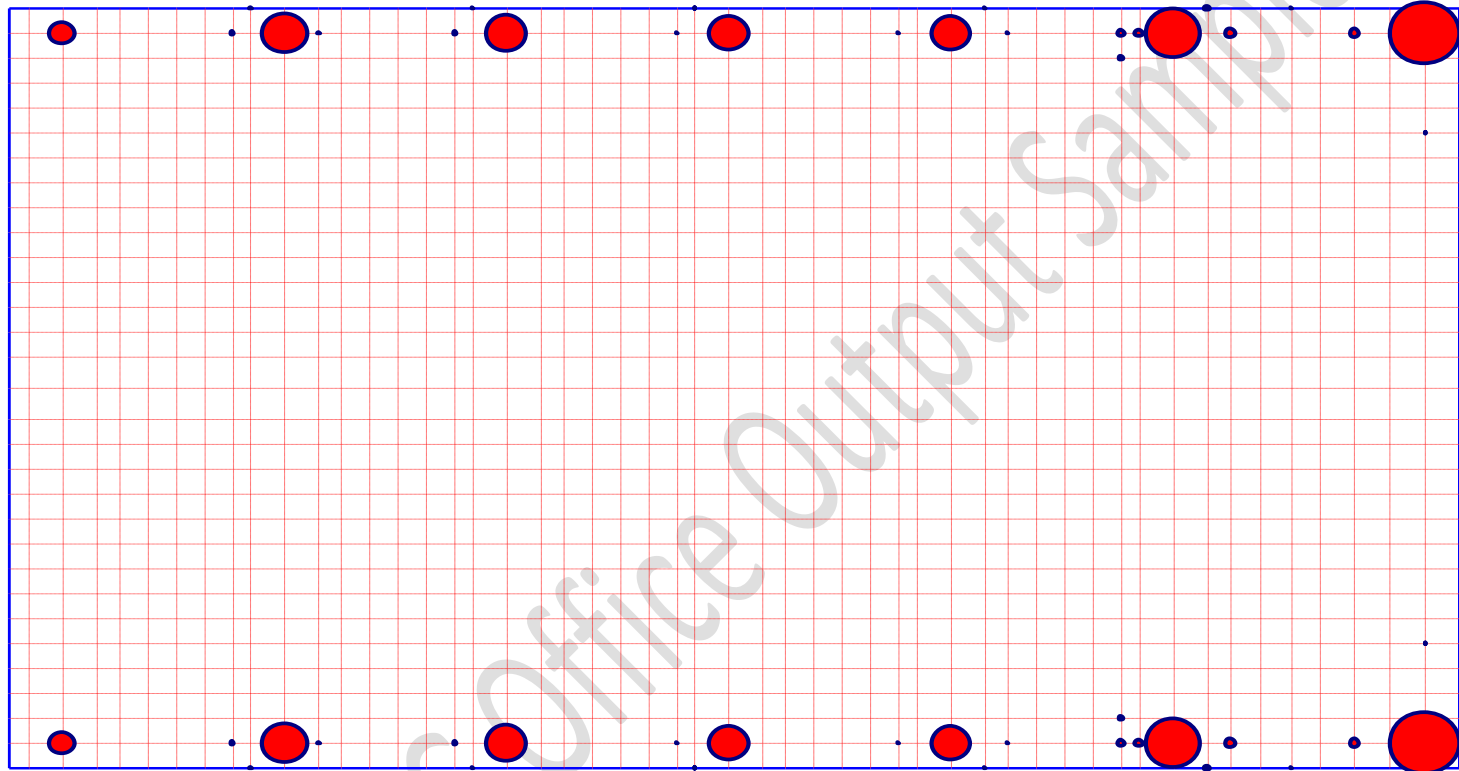

Top reinforcement in y-direction A_{s_topy} [cm²/m]
Max. A_{s_topy} = 8.33 at node 1612, Min. A_{s_topy} = 0.02 at node 190

GEOTEC Software

P. O. Box 465, Port-Said, Egypt* Tel. +2066-3609247

Scale 1:250

File: Pile cap design

Page No.:

Title: Pile foundation design-left side

Date: 25/09/2010

Project: Tarut bridge, Qatif city- Saudi Arabia

Tarut Bridge - Analysis and design of foundation

Method (2)
Modulus of subgrade reaction is defined by the user

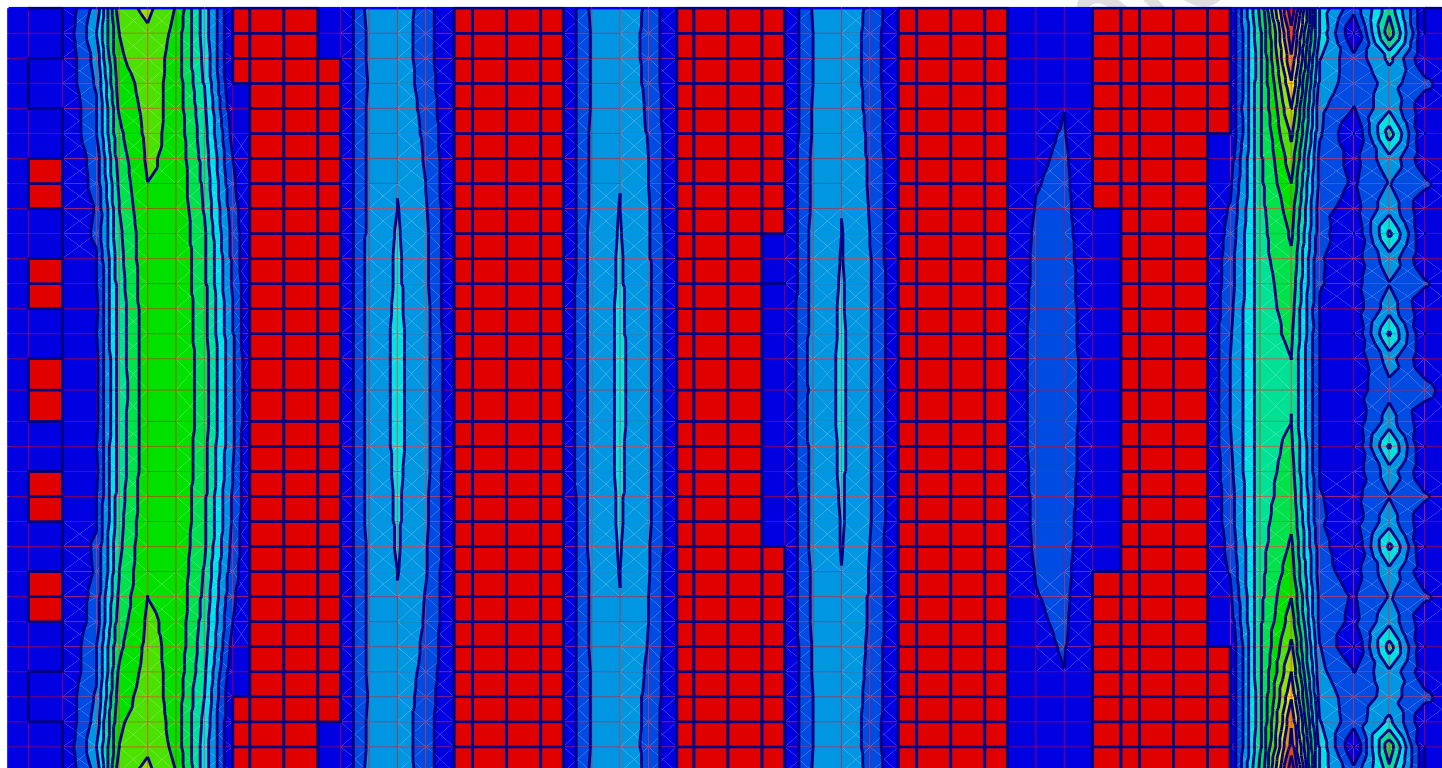
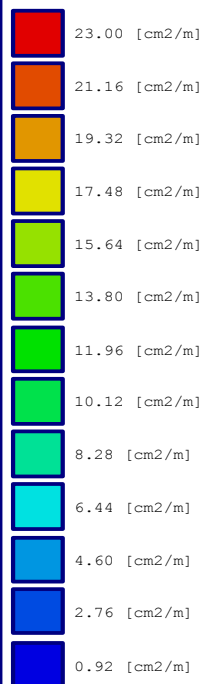

Bottom reinforcement in x-direction A_{s_botx} [cm2/m]
Max. A_{s_botx} = 23.89 at node 88, Min. A_{s_botx} = 0.00 at node 62

GEOTEC Software

P. O. Box 465, Port-Said, Egypt* Tel. +2066-3609247

Scale 1:250

File: Pile cap design

Page No.:

Title: Pile foundation design-left side

Date: 25/09/2010

Project: Tarut bridge, Qatif city- Saudi Arabia

Tarut Bridge - Analysis and design of foundation

Method (2)

Modulus of subgrade reaction is defined by the user

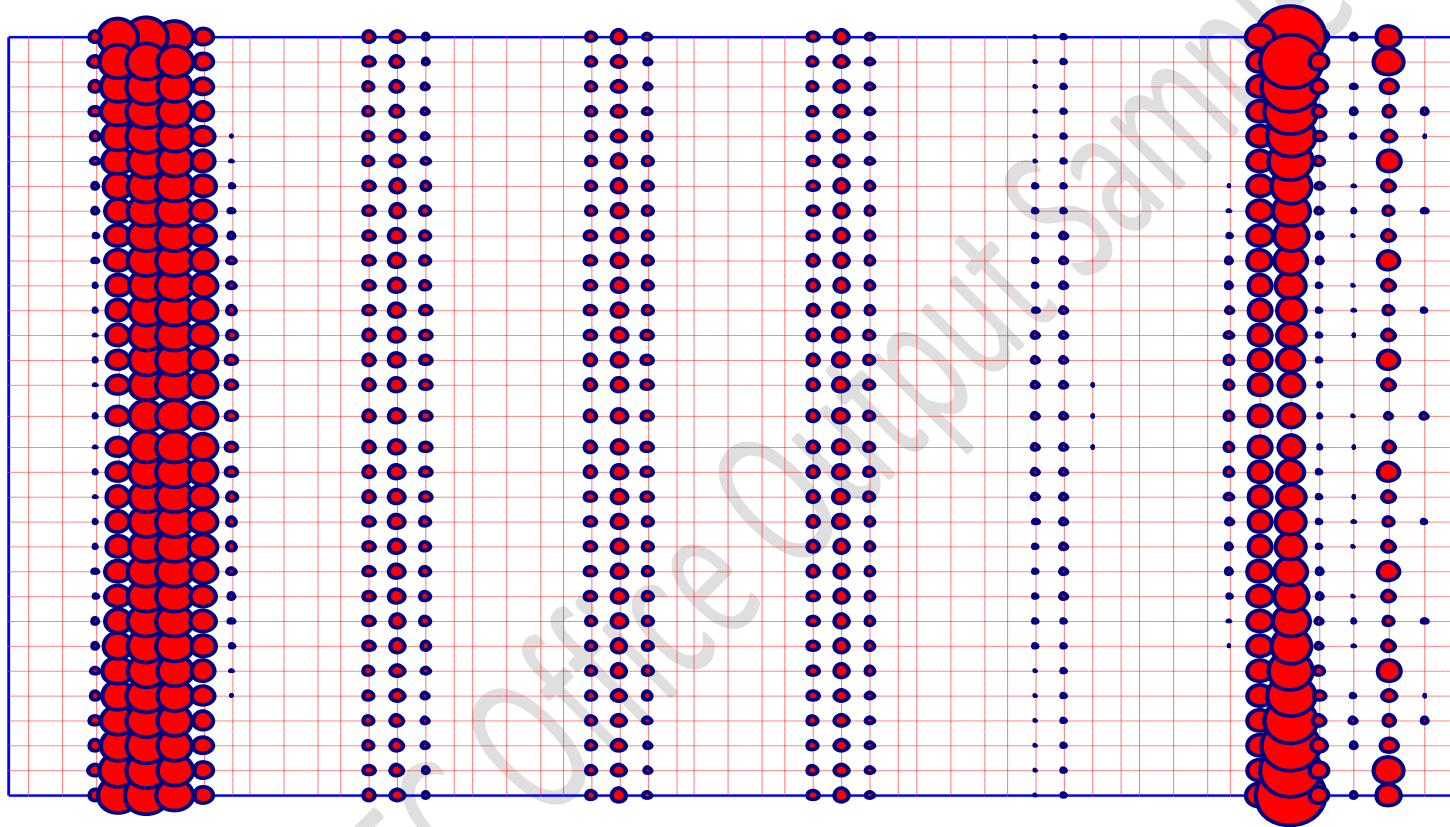

Bottom reinforcement in x-direction A_{s_botx} [cm²/m]

Max. A_{s_botx} = 23.89 at node 88, Min. A_{s_botx} = 0.00 at node 62

GEOTEC Software

P. O. Box 465, Port-Said, Egypt* Tel. +2066-3609247

Scale 1:250

File: Pile cap design

Page No.:

Title: Pile foundation design-left side

Date: 25/09/2010

Project: Tarut bridge, Qatif city- Saudi Arabia

Tarut Bridge - Analysis and design of foundation

Method (2)

Modulus of subgrade reaction is defined by the user

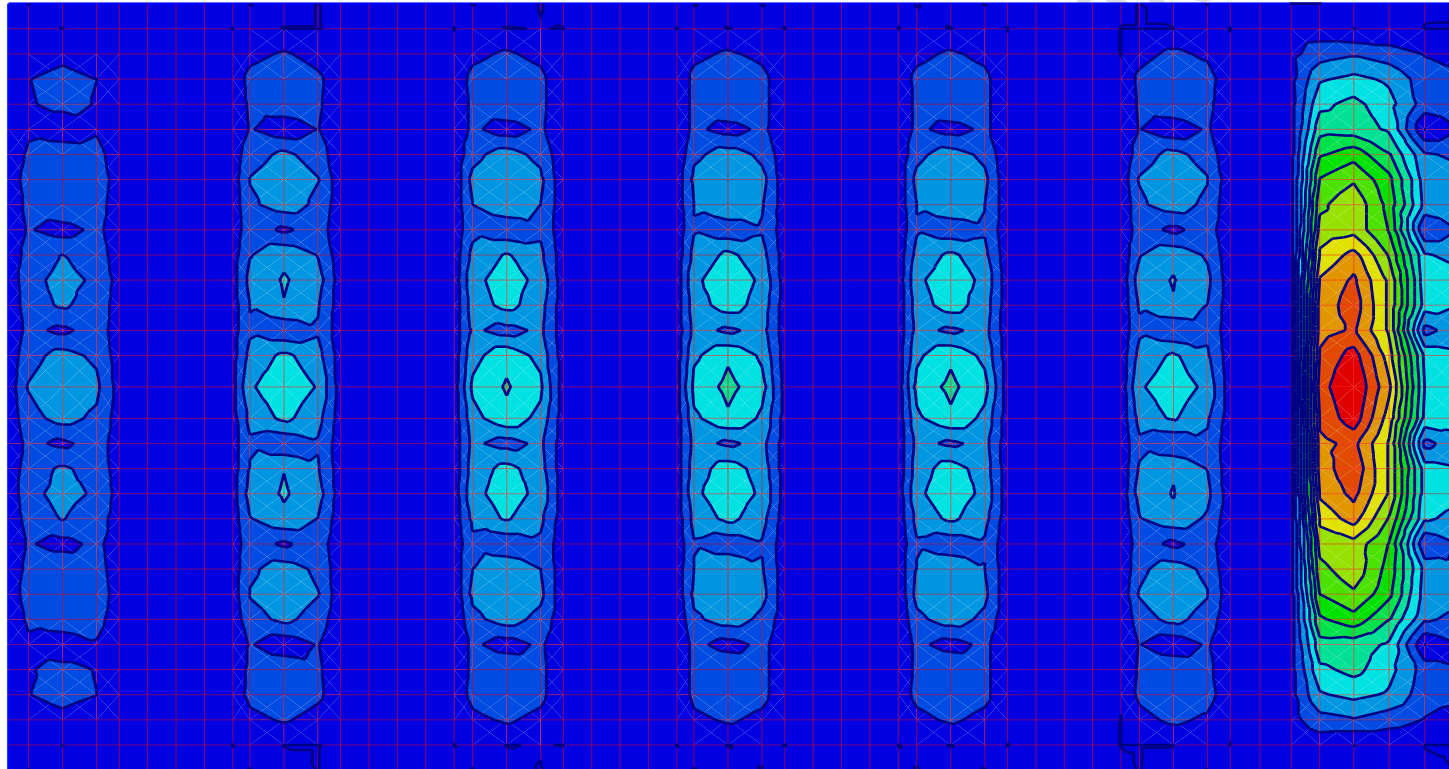
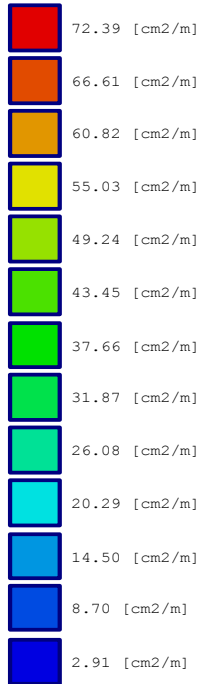

Bottom reinforcement in y-direction A_{s_boty} [cm2/m]

Max. A_{s_boty} = 75.27 at node 910, Min. A_{s_boty} = 0.02 at node 51

GEOTEC Software

P. O. Box 465, Port-Said, Egypt* Tel. +2066-3609247

Scale 1:250

File: Pile cap design

Page No.:

Title: Pile foundation design-left side

Date: 25/09/2010

Project: Tarut bridge, Qatif city- Saudi Arabia

Tarut Bridge - Analysis and design of foundation

Method (2)

Modulus of subgrade reaction is defined by the user

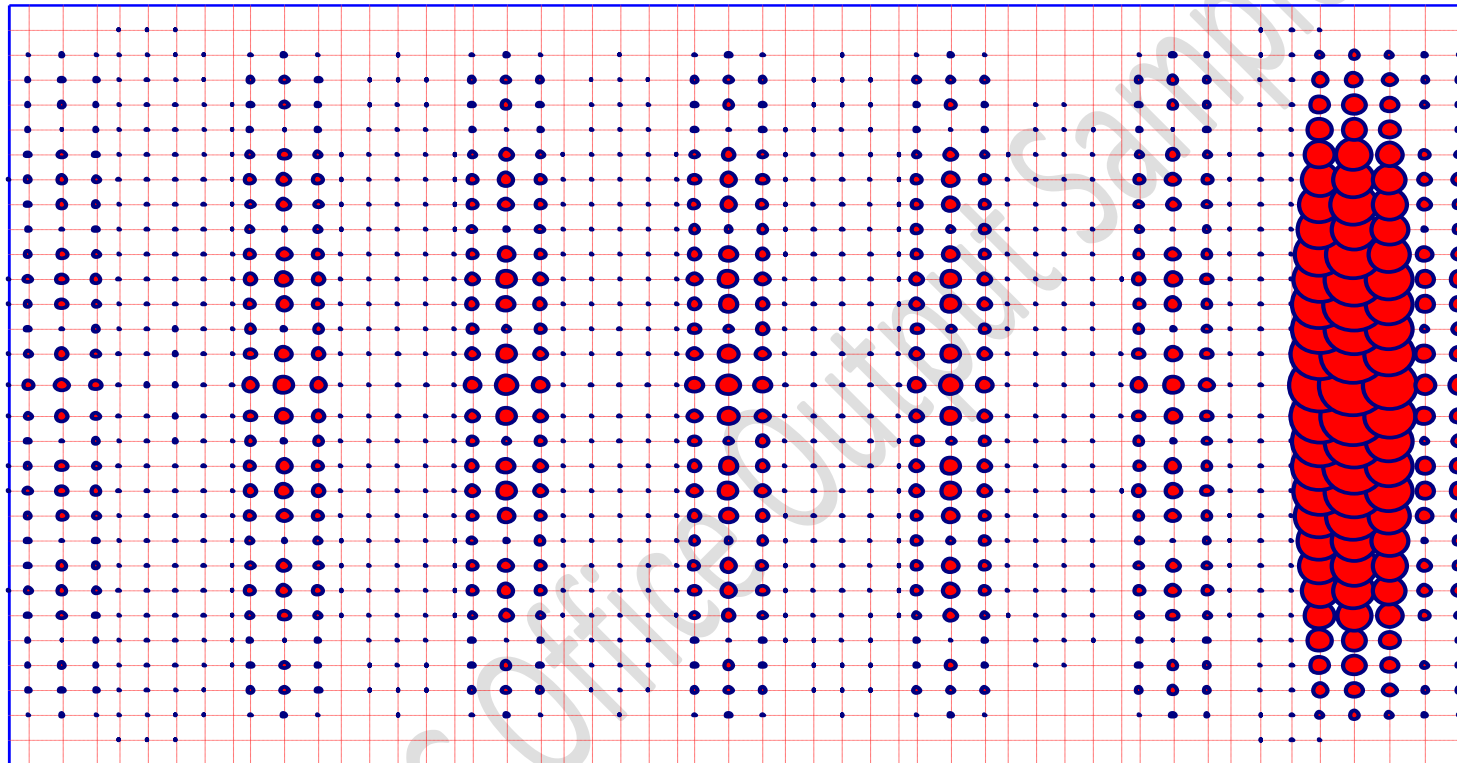

Bottom reinforcement in y-direction A_{s_boty} [cm²/m]

Max. A_{s_boty} = 75.27 at node 910, Min. A_{s_boty} = 0.02 at node 51

GEO-TEC Software

P. O. Box 465, Port-Said, Egypt* Tel. +2066-3609247

Scale 1:250

File: Pile cap design

Page No.:

Title: Pile foundation design-left side

Date: 25/09/2010

Project: Tarut bridge, Qatif city- Saudi Arabia

10 Pile foundation analysis - right side

```
*****  
Analysis of slab foundation  
by the program package ELPLA  
Version 9.2 SP1  
*****
```

Title: Pile foundation analysis-rigiht side
Date: 25/09/2010
Project: Tarut bridge, Qatif city- Saudi Arabia
File: Pile foundation analysis_right side

Calculation method:
Method (9) (Layered soil model)
Rigid free-standing raft

Program authors Prof. M. El Gendy/ Dr. A. El Gendy
GEOTEC Software Inc. PO Box 14001 Richmond Road PO, Calgary AB, Canada T3E 7Y7
www.geotecsoftware.com; geotec@geotecsoftware.com ; Tele.:+1(587) 332-3323

Tarut Bridge - Analysis and design of foundation

GEOTEC

PO Box 14001 Richmond Road PO, Calgary AB, Canada T3E 7Y7

Soil data

Page

Title: Pile foundation analysis-right side
Date: 25/09/2010
Project: Tarut bridge, Qatif city- Saudi Arabia
File: Pile foundation analysis_right side

Analysis of slab foundation
by the program package ELPLA
Version 9.2 SP1

Calculation method:
Method (9) (Layered soil model)
Rigid free-standing raft

Soil data

Groundwater depth under the ground surface GW [m] = 0
Settlement reduction factor Alfa [-] = 1

B o r i n g l a y e r s

Boring log No.: 1
Boring Log Label: B1
Location of boring in global coordinates system

Xb [m] = 0.00
Yb [m] = 0.00

Layer No.: 1

Symbole for soil type and rocks after DIN 4023: S+U

Level of layer under ground

z [m] = 5.50

Modulus of Elasticity of the soil (Loading)

E [kN/m²] = 18500

Modulus of Elasticity of the soil (Reloading)

W [kN/m²] = 18500

Poisson's ratio of soil

Nue [-] = 0.30

Unit weight of the soil

Gama [kN/m³] = 6.2

Angle of internal friction

Fhi [°] = 30.00

Cohesion of the soil

c [kN/m²] = 0

Layer No.: 2

Symbole for soil type and rocks after DIN 4023: T

Level of layer under ground

z [m] = 10.00

Modulus of Elasticity of the soil (Loading)

E [kN/m²] = 10000

Modulus of Elasticity of the soil (Reloading)

W [kN/m²] = 10000

Poisson's ratio of soil

Nue [-] = 0.30

Unit weight of the soil

Gama [kN/m³] = 5.2

Angle of internal friction

Fhi [°] = 0.00

Cohesion of the soil

c [kN/m²] = 75

Layer No.: 3

Symbole for soil type and rocks after DIN 4023: S+U

Level of layer under ground

z [m] = 30.00

Modulus of Elasticity of the soil (Loading)

E [kN/m²] = 43000

Modulus of Elasticity of the soil (Reloading)

W [kN/m²] = 43000

Poisson's ratio of soil

Nue [-] = 0.30

Unit weight of the soil

Gama [kN/m³] = 9.2

Angle of internal friction

Fhi [°] = 36.00

Cohesion of the soil

c [kN/m²] = 0

Layer No.: 4

Symbole for soil type and rocks after DIN 4023: T

Level of layer under ground

z [m] = 50.00

Modulus of Elasticity of the soil (Loading)

E [kN/m²] = 47000

Modulus of Elasticity of the soil (Reloading)

W [kN/m²] = 47000

Poisson's ratio of soil

Nue [-] = 0.30

Unit weight of the soil

Gama [kN/m³] = 9.7

Angle of internal friction

Fhi [°] = 0.00

Cohesion of the soil

c [kN/m²] = 200

GEOTEC

Tarut Bridge - Analysis and design of foundation

PO Box 14001 Richmond Road PO, Calgary AB, Canada T3E 7Y7

Slab properties/ Foundation level/ Global coordinates

Page

Title: Pile foundation analysis-right side
Date: 25/09/2010
Project: Tarut bridge, Qatif city- Saudi Arabia
File: Pile foundation analysis_right side

Analysis of slab foundation
by the program package ELPLA
Version 9.2 SP1

Calculation method:
Method (9) (Layered soil model)
Rigid free-standing raft

Slab properties/ Foundation level/ Global coordinates

Unit weight of slab material GB [kN/m3] = 25.0

Element groups (with the same thickness and material):

Group No.	E-Modulus of slab Ep [kN/m2]	Poisson's ratio Nue [-]	Slab thickness d [m]
1	2.4E+07	0.2	0.5
2	2.4E+07	0.2	1.36
3	2.4E+07	0.2	3.29
4	2.4E+07	0.2	1.69

GEOTEC Office Output Sample

GEOTEC

PO Box 14001 Richmond Road PO, Calgary AB, Canada T3E 7Y7

Tarut Bridge - Analysis and design of foundation

Loads

Page

Title: Pile foundation analysis-right side
 Date: 25/09/2010
 Project: Tarut bridge, Qatif city- Saudi Arabia
 File: Pile foundation analysis_right side

Analysis of slab foundation
 by the program package ELPLA
 Version 9.2 SP1

Calculation method:
 Method (9) (Layered soil model)
 Rigid free-standing raft

Loading

Line loads:

Load No.	Load start value	Load end value	Load start	Load start	Load end	Load end
I	P1	P1	x1	y1	x2	y2
[-]	[kN/m]	[kN/m]	[m]	[m]	[m]	[m]
1	345.54	345.54	49.001	0	49.001	33.878

Distributed loads (Rectangle):

Load No.	Load value	Load start	Load start	Load end	Load end
I	P	x1	y1	x2	y2
[-]	[kN/m2]	[m]	[m]	[m]	[m]
1	13	0	44.421	51.552	0

Loading data:

Distribute column loads: (No)

Slab weight	Pe	[kN]	=	44679.2
Force on slab	Pa	[kN]	=	103464.5
Groundwater force	Pw	[kN]	=	0.0
Total load ($P = Pe + Pa - Pw$)	P	[kN]	=	148143.7
Groundwater pressure on raft	Qw	[kN/m ²]	=	0.0
Average contact pressure	Qo	[kN/m ²]	=	76.2

Sum Mx from loads	Mx	[kN.m]	=	-47718.5
Sum My from loads	My	[kN.m]	=	587046.6

Eccentricity of loading in x-direction	ex	[cm]	=	396.27
Eccentricity of loading in y-direction	ey	[cm]	=	-32.21

Moment of inertia of slab about x-Axis	Ix	[m ⁴]	=	238867.70
Moment of inertia of slab about y-Axis	Iy	[m ⁴]	=	414681.59
Product of inertia	Ixy	[m ⁴]	=	-25825.42
Area of the slab	A	[m ²]	=	1942.88
Volume of the slab	V	[m ³]	=	1787.17

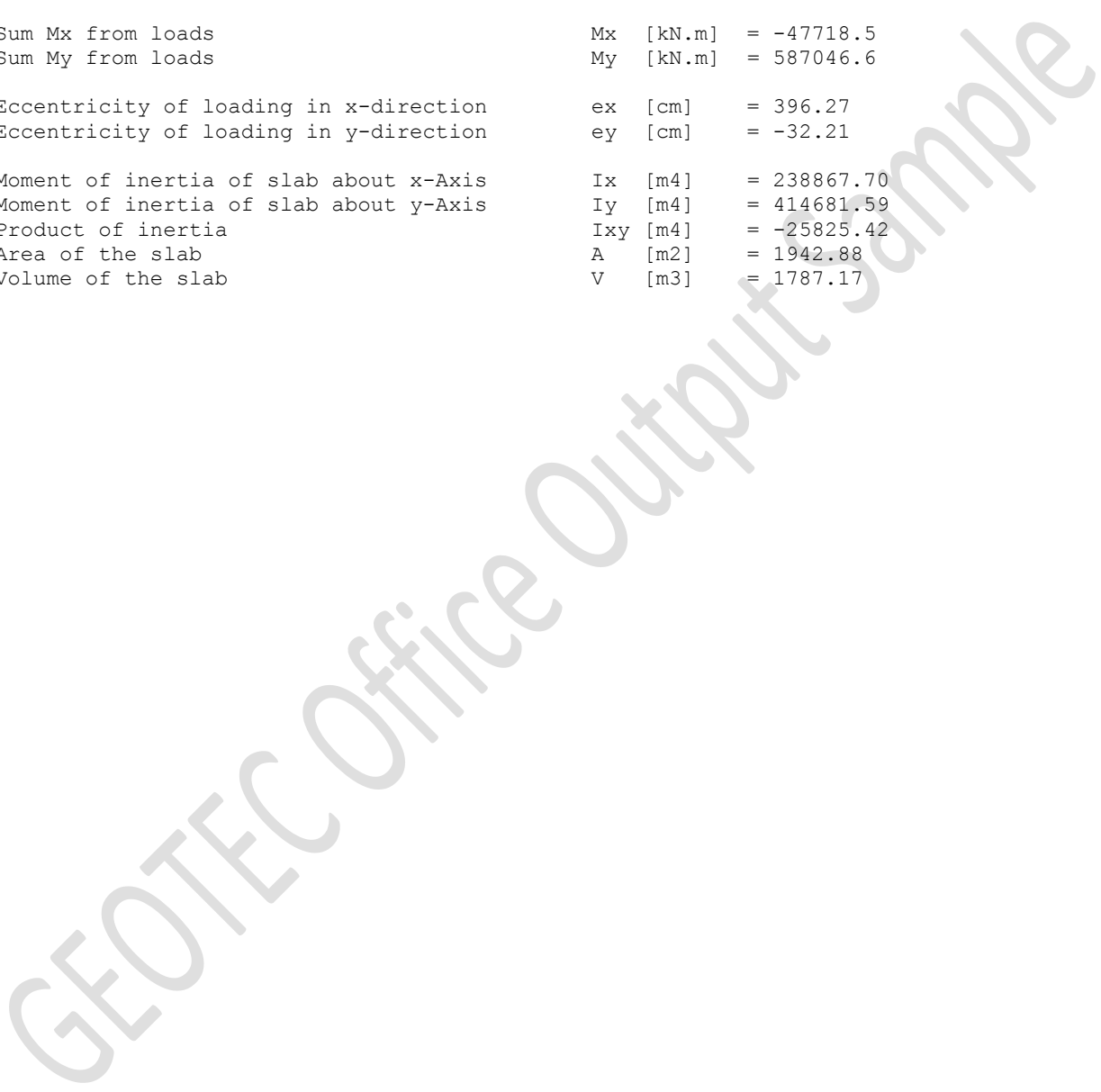

Tarut Bridge - Analysis and design of foundation

Title: Pile foundation analysis-right side
 Date: 25/09/2010
 Project: Tarut bridge, Qatif city- Saudi Arabia
 File: Pile foundation analysis_right side

Analysis of slab foundation
 by the program package ELPLA
 Version 9.2 SP1

Calculation method:
 Method (9) (Layered soil model)
 Rigid free-standing raft

File groups:

Group No.: 1
 Description of pile groups: P1
 Pile diameter
 Pile toe diameter
 Pile length

D [m] = 1.2
 Df [m] = 1.2
 Lg [m] = 28

Soil data under the pile tip:

File tip resistance (s/Df = 0.02) Sig [kN/m2] = 800
 File tip resistance (s/Df = 0.03) Sig1 [kN/m2] = 1100
 File tip resistance (s/Df = 0.1) SigGR [kN/m2] = 2442

Geotechnical data of the layer:

Layer No.	Layer thickness L1	Undrainage cohesion Cu	Penetration resistance qs	Skin friction Tau
[-]	[m]	[kN/m2]	[kN/m2]	[kN/m2]
1	5.50	---	---	0.0
2	4.50	---	---	35.0
3	18.00	---	---	100.0

File locations and groups:

File No.	Node No.	X-coord.	Y-coord.	Group No.
[-]	[-]	[m]	[m]	[-]
1	173	2.12	1.20	1
2	179	9.95	1.20	1
3	185	17.78	1.20	1
4	191	25.61	1.20	1
5	197	33.44	1.20	1
6	203	41.27	1.20	1
7	208	47.85	1.20	1
8	210	50.25	1.20	1
9	290	2.12	5.70	1
10	296	9.95	5.70	1
11	302	17.78	5.70	1
12	308	25.61	5.70	1
13	314	33.44	5.70	1
14	320	41.27	5.70	1
15	325	47.85	5.70	1
16	327	50.25	5.70	1
17	407	2.12	10.20	1
18	413	9.95	10.20	1

Continue of table at next page

GEOTEC
 PO Box 14001 Richmond Road PO, Calgary AB, Canada T3E 7Y7

Data of piles

Page

Tarut Bridge - Analysis and design of foundation

Continue of table

File No. [-]	Node No. [-]	X-coord. [m]	Y-coord. [m]	Group No. [-]
19	419	17.78	10.20	1
20	425	25.61	10.20	1
21	431	33.44	10.20	1
22	437	41.27	10.20	1
23	442	47.85	10.20	1
24	444	50.25	10.20	1
25	524	2.12	14.70	1
26	530	9.95	14.70	1
27	536	17.78	14.70	1
28	542	25.61	14.70	1
29	548	33.44	14.70	1
30	554	41.27	14.70	1
31	559	47.85	14.70	1
32	561	50.25	14.70	1
33	641	2.12	19.20	1
34	647	9.95	19.20	1
35	653	17.78	19.20	1
36	659	25.61	19.20	1
37	665	33.44	19.20	1
38	671	41.27	19.20	1
39	676	47.85	19.20	1
40	678	50.25	19.20	1
41	758	2.12	23.70	1
42	764	9.95	23.70	1
43	770	17.78	23.70	1
44	776	25.61	23.70	1
45	782	33.44	23.70	1
46	788	41.27	23.70	1
47	793	47.85	23.70	1
48	795	50.25	23.70	1
49	875	2.12	28.20	1
50	881	9.95	28.20	1
51	887	17.78	28.20	1
52	893	25.61	28.20	1
53	899	33.44	28.20	1
54	905	41.27	28.20	1
55	910	47.85	28.20	1
56	912	50.25	28.20	1
57	1098	50.25	32.70	1
58	1096	47.85	32.70	1
59	1091	41.27	32.70	1
60	1085	33.44	32.70	1
61	1079	25.61	32.70	1
62	1073	17.78	32.70	1
63	1067	9.95	32.70	1
64	1063	3.32	32.70	1
65	1236	9.95	37.20	1
66	1242	17.78	37.20	1
67	1288	9.95	41.70	1
68	1215	6.32	36.45	1
69	1229	25.61	36.45	1
70	1212	33.44	35.70	1

File material:

Modulus of elasticity of pile Ep [kN/m²] = 24000000.00
 Unit weight of pile concrete GP [kN/m³] = 30.00
 (The 5 m pile length above the bed level is considered by
 assuming an equivalent unit weight of pile concrete)

GEOTEC

PO Box 14001 Richmond Road PO, Calgary AB, Canada T3E 7Y7

Support reactions

Page

Title: Pile foundation analysis-right side

Tarut Bridge - Analysis and design of foundation

Date: 25/09/2010
 Project: Tarut bridge, Qatif city- Saudi Arabia
 File: Pile foundation analysis_right side

Analysis of slab foundation
 by the program package ELPLA
 Version 9.2 SP1

Calculation method:
 Method (9) (Layered soil model)
 Rigid free-standing raft

Support reactions

Node No.	Load-V	Moment-Y	Moment-X
I	V	My	Mx
[-]	[kN]	[kN.m]	[kN.m]
173	2621.3	0.0	0.0
179	2363.1	0.0	0.0
185	2347.4	0.0	0.0
191	2431.7	0.0	0.0
197	2573.8	0.0	0.0
203	2760.0	0.0	0.0
208	2990.1	0.0	0.0
210	3339.8	0.0	0.0
290	2209.7	0.0	0.0
296	1914.3	0.0	0.0
302	1879.1	0.0	0.0
308	1939.5	0.0	0.0
314	2049.1	0.0	0.0
320	2188.6	0.0	0.0
325	2393.9	0.0	0.0
327	2731.6	0.0	0.0
407	2010.6	0.0	0.0
413	1698.6	0.0	0.0
419	1651.8	0.0	0.0
425	1700.8	0.0	0.0
431	1797.4	0.0	0.0
437	1927.4	0.0	0.0
442	2146.7	0.0	0.0
444	2474.7	0.0	0.0
524	1917.2	0.0	0.0
530	1597.6	0.0	0.0
536	1545.6	0.0	0.0
542	1591.3	0.0	0.0
548	1686.0	0.0	0.0
554	1818.9	0.0	0.0
559	2049.5	0.0	0.0
561	2373.1	0.0	0.0
641	1893.6	0.0	0.0
647	1568.1	0.0	0.0
653	1516.4	0.0	0.0
659	1565.8	0.0	0.0
665	1667.6	0.0	0.0
671	1810.6	0.0	0.0

Continue of table at next page

GEOTEC
 PO Box 14001 Richmond Road PO, Calgary AB, Canada T3E 7Y7

Support reactions

Page

Continue of table

Tarut Bridge - Analysis and design of foundation

Node No.	Load-V	Moment-Y	Moment-X
I	V	My	Mx
[-]	[kN]	[kN.m]	[kN.m]
676	2048.5	0.0	0.0
678	2374.1	0.0	0.0
758	1930.9	0.0	0.0
764	1595.1	0.0	0.0
770	1551.5	0.0	0.0
776	1612.8	0.0	0.0
782	1733.0	0.0	0.0
788	1899.2	0.0	0.0
793	2143.6	0.0	0.0
795	2478.1	0.0	0.0
875	2044.3	0.0	0.0
881	1679.6	0.0	0.0
887	1660.7	0.0	0.0
893	1745.1	0.0	0.0
899	1900.5	0.0	0.0
905	2128.5	0.0	0.0
910	2387.8	0.0	0.0
912	2738.2	0.0	0.0
1063	2163.0	0.0	0.0
1067	1838.0	0.0	0.0
1073	1887.1	0.0	0.0
1079	2005.6	0.0	0.0
1085	2208.0	0.0	0.0
1091	2645.5	0.0	0.0
1096	2980.2	0.0	0.0
1098	3352.3	0.0	0.0
1212	2631.0	0.0	0.0
1215	2217.7	0.0	0.0
1229	2457.9	0.0	0.0
1236	2160.8	0.0	0.0
1242	2354.8	0.0	0.0
1288	2847.4	0.0	0.0
Sum. V	148143.7		

GEOTEC Office Output Sample

GEOTEC
PO Box 14001 Richmond Road PO, Calgary AB, Canada T3E 7Y7

File results

Page

Title: Pile foundation analysis-right side
Date: 25/09/2010
Project: Tarut bridge, Qatif city- Saudi Arabia

Tarut Bridge - Analysis and design of foundation

File: Pile foundation analysis_right side

Analysis of slab foundation
by the program package ELPLA
Version 9.2 SP1

Calculation method:
Method (9) (Layered soil model)
Rigid free-standing raft

File results

Value of total load (including own wt.)	Po	[kN]	=	148143.7
Total pile loads	PL	[kN]	=	148143.7
Bearing factor of piled raft	Alfa-Kpp	[%]	=	100.00

File loads and displacements

Pile No.	pile load Fr [kN]	Settlement Sr [cm]	Soil stiffness ks [kN/m]
1	2621.3	1.75	150101.3
2	2363.1	2.08	113874.4
3	2347.4	1.86	126275.4
4	2431.6	2.01	121141.6
5	2573.8	1.61	159789.9
6	2760.0	2.26	121919.7
7	2990.1	1.60	186324.1
8	3339.8	1.77	188712.2
9	2209.7	2.04	108508.8
10	1914.3	2.30	83086.9
11	1879.1	2.00	94082.0
12	1939.5	1.90	102168.7
13	2049.1	1.67	122931.8
14	2188.6	2.19	99986.5
15	2393.9	2.00	119466.6
16	2731.6	1.76	155513.1
17	2010.6	2.21	91164.1
18	1698.6	1.86	91359.7
19	1651.8	2.19	75496.7
20	1700.8	1.97	86257.2
21	1797.4	2.12	84780.6
22	1927.4	1.60	120530.4
23	2146.7	2.34	91586.0
24	2474.7	2.21	112088.3
25	1917.2	2.29	83871.5
26	1597.6	2.15	74334.4
27	1545.6	1.69	91449.5
28	1591.3	2.11	75410.5
29	1686.0	2.01	83832.6
30	1818.9	1.78	102203.6
31	2049.5	1.80	113924.4
32	2373.1	2.29	103581.8
33	1893.6	2.32	81536.2

Continue of table at next page

GEOTEC
PO Box 14001 Richmond Road PO, Calgary AB, Canada T3E 7Y7

File results Page

Continue of table

Pile No.	pile load	Settlement	Soil stiffness
----------	-----------	------------	----------------

Tarut Bridge - Analysis and design of foundation

I	Fr	Sr	ks
[-]	[kN]	[cm]	[kN/m]
34	1568.1	2.32	67658.9
35	1516.4	1.97	76895.5
36	1565.8	2.30	68073.8
37	1667.6	2.08	79995.7
38	1810.6	2.23	81087.8
39	2048.5	1.72	119164.9
40	2374.1	1.62	146227.5
41	1930.9	1.69	114390.4
42	1595.1	1.71	93517.8
43	1551.5	2.26	68584.9
44	1612.8	1.80	89452.0
45	1733.0	2.22	77958.2
46	1899.2	2.12	89415.4
47	2143.6	2.25	95355.2
48	2478.1	1.79	138585.4
49	2044.3	1.97	103653.8
50	1679.6	1.76	95435.9
51	1660.7	1.70	97475.0
52	1745.1	2.08	83703.9
53	1900.5	1.69	112704.7
54	2128.5	2.20	96859.7
55	2387.8	2.03	117829.6
56	2738.2	1.95	140656.0
57	3352.3	2.01	166524.8
58	2980.2	2.29	130008.4
59	2645.5	1.96	134818.3
60	2208.0	1.62	136616.5
61	2005.6	2.02	99351.1
62	1887.1	2.10	89971.5
63	1838.0	2.14	85874.7
64	2163.0	1.88	115079.5
65	2160.8	1.75	123718.9
66	2354.8	2.21	106538.0
67	2847.4	1.86	153134.7
68	2217.7	1.75	126693.5
69	2457.9	2.11	116492.4
70	2631.0	1.69	155310.2

File loads

File No.	Skin resistance	Tip resistance	Total load
I	Qma	Qsp	Fr
[-]	[kN]	[kN]	[kN]
1	2197.4	319.9	2621.3
2	1999.0	291.0	2363.1
3	1987.1	289.3	2347.4
4	2056.7	299.4	2431.6
5	2177.0	317.0	2573.8
6	2338.6	340.5	2760.0
7	2538.8	369.6	2990.1
8	2794.2	406.8	3339.8
9	1887.0	274.7	2209.7
10	1672.8	243.6	1914.3
11	1650.6	240.3	1879.1

Continue of table at next page

GEOTEC

PO Box 14001 Richmond Road PO, Calgary AB, Canada T3E 7Y7

File results

Page

Continue of table

File No.	Skin resistance	Tip resistance	Total load
I	Qma	Qsp	Fr

Tarut Bridge - Analysis and design of foundation

[-]	[kN]	[kN]	[kN]
12	1704.7	248.2	1939.5
13	1801.8	262.3	2049.1
14	1928.3	280.7	2188.6
15	2102.1	306.1	2393.9
16	2342.1	341.0	2731.6
17	1733.8	252.4	2010.6
18	1512.2	220.2	1698.6
19	1483.3	216.0	1651.8
20	1529.8	222.7	1700.8
21	1617.3	235.5	1797.4
22	1734.8	252.6	1927.4
23	1913.0	278.5	2146.7
24	2144.1	312.2	2474.7
25	1660.9	241.8	1917.2
26	1435.8	209.0	1597.6
27	1403.9	204.4	1545.6
28	1448.1	210.8	1591.3
29	1534.1	223.4	1686.0
30	1652.6	240.6	1818.9
31	1836.5	267.4	2049.5
32	2063.8	300.5	2373.1
33	1642.2	239.1	1893.6
34	1413.6	205.8	1568.1
35	1382.3	201.2	1516.4
36	1429.3	208.1	1565.8
37	1520.5	221.4	1667.6
38	1646.3	239.7	1810.6
39	1835.6	267.3	2048.5
40	2064.3	300.5	2374.1
41	1671.0	243.3	1930.9
42	1435.5	209.0	1595.1
43	1409.9	205.3	1551.5
44	1465.6	213.4	1612.8
45	1570.0	228.6	1733.0
46	1713.4	249.5	1899.2
47	1909.9	278.1	2143.6
48	2145.4	312.4	2478.1
49	1757.5	255.9	2044.3
50	1502.0	218.7	1679.6
51	1493.6	217.5	1660.7
52	1565.6	227.9	1745.1
53	1695.0	246.8	1900.5
54	1883.1	274.2	2128.5
55	2095.9	305.2	2387.8
56	2344.7	341.4	2738.2
57	2798.2	407.4	3352.3
58	2527.4	368.0	2980.2
59	2252.4	327.9	2645.5
60	1920.8	279.7	2208.0
61	1758.0	255.9	2005.6
62	1662.5	242.1	1887.1
63	1624.8	236.6	1838.0
64	1851.4	269.6	2163.0
65	1866.9	271.8	2160.8
66	2000.9	291.3	2354.8
67	2375.3	345.8	2847.4

Continue of table at next page

GEOTEC
PO Box 14001 Richmond Road PO, Calgary AB, Canada T3E 7Y7

Pile results	Page
--------------	------

Continue of table

Pile No.	Skin resistance	Tip resistance	Total load
I	Q _{ma}	Q _{sp}	Fr
[-]	[kN]	[kN]	[kN]

Tarut Bridge - Analysis and design of foundation

68	1902.2	276.9	2217.7
69	2080.5	302.9	2457.9
70	2220.0	323.2	2631.0

File settlements

File No. I [-]	Self settlement Sv [cm]	Settlement Sr-Sv [cm]	Sum of settlements Sr [cm]
1	0.89	0.86	1.75
2	0.81	1.27	2.08
3	0.80	1.06	1.86
4	0.83	1.18	2.01
5	0.88	0.73	1.61
6	0.94	1.32	2.26
7	1.03	0.58	1.60
8	1.13	0.64	1.77
9	0.76	1.27	2.04
10	0.68	1.63	2.30
11	0.67	1.33	2.00
12	0.69	1.21	1.90
13	0.73	0.94	1.67
14	0.78	1.41	2.19
15	0.85	1.15	2.00
16	0.95	0.81	1.76
17	0.70	1.51	2.21
18	0.61	1.25	1.86
19	0.60	1.59	2.19
20	0.62	1.35	1.97
21	0.65	1.47	2.12
22	0.70	0.90	1.60
23	0.77	1.57	2.34
24	0.87	1.34	2.21
25	0.67	1.62	2.29
26	0.58	1.57	2.15
27	0.57	1.12	1.69
28	0.58	1.53	2.11
29	0.62	1.39	2.01
30	0.67	1.11	1.78
31	0.74	1.06	1.80
32	0.83	1.46	2.29
33	0.66	1.66	2.32
34	0.57	1.75	2.32
35	0.56	1.41	1.97
36	0.58	1.72	2.30
37	0.61	1.47	2.08
38	0.66	1.57	2.23
39	0.74	0.98	1.72
40	0.83	0.79	1.62
41	0.67	1.01	1.69
42	0.58	1.13	1.71
43	0.57	1.69	2.26
44	0.59	1.21	1.80
45	0.63	1.59	2.22

Continue of table at next page

GEOTEC

PO Box 14001 Richmond Road PO, Calgary AB, Canada T3E 7Y7

File results

Page

Continue of table

File No. I [-]	Self settlement Sv [cm]	Settlement Sr-Sv [cm]	Sum of settlements Sr [cm]
----------------------	-------------------------------	-----------------------------	----------------------------------

Tarut Bridge - Analysis and design of foundation

46	0.69	1.43	2.12
47	0.77	1.48	2.25
48	0.87	0.92	1.79
49	0.71	1.26	1.97
50	0.61	1.15	1.76
51	0.60	1.10	1.70
52	0.63	1.45	2.08
53	0.68	1.00	1.69
54	0.76	1.44	2.20
55	0.85	1.18	2.03
56	0.95	1.00	1.95
57	1.13	0.88	2.01
58	1.02	1.27	2.29
59	0.91	1.05	1.96
60	0.78	0.84	1.62
61	0.71	1.31	2.02
62	0.67	1.43	2.10
63	0.66	1.48	2.14
64	0.75	1.13	1.88
65	0.75	0.99	1.75
66	0.81	1.40	2.21
67	0.96	0.90	1.86
68	0.77	0.98	1.75
69	0.84	1.27	2.11
70	0.90	0.80	1.69

GEOTEC Office Output Sample

Tarut Bridge - Analysis and design of foundation

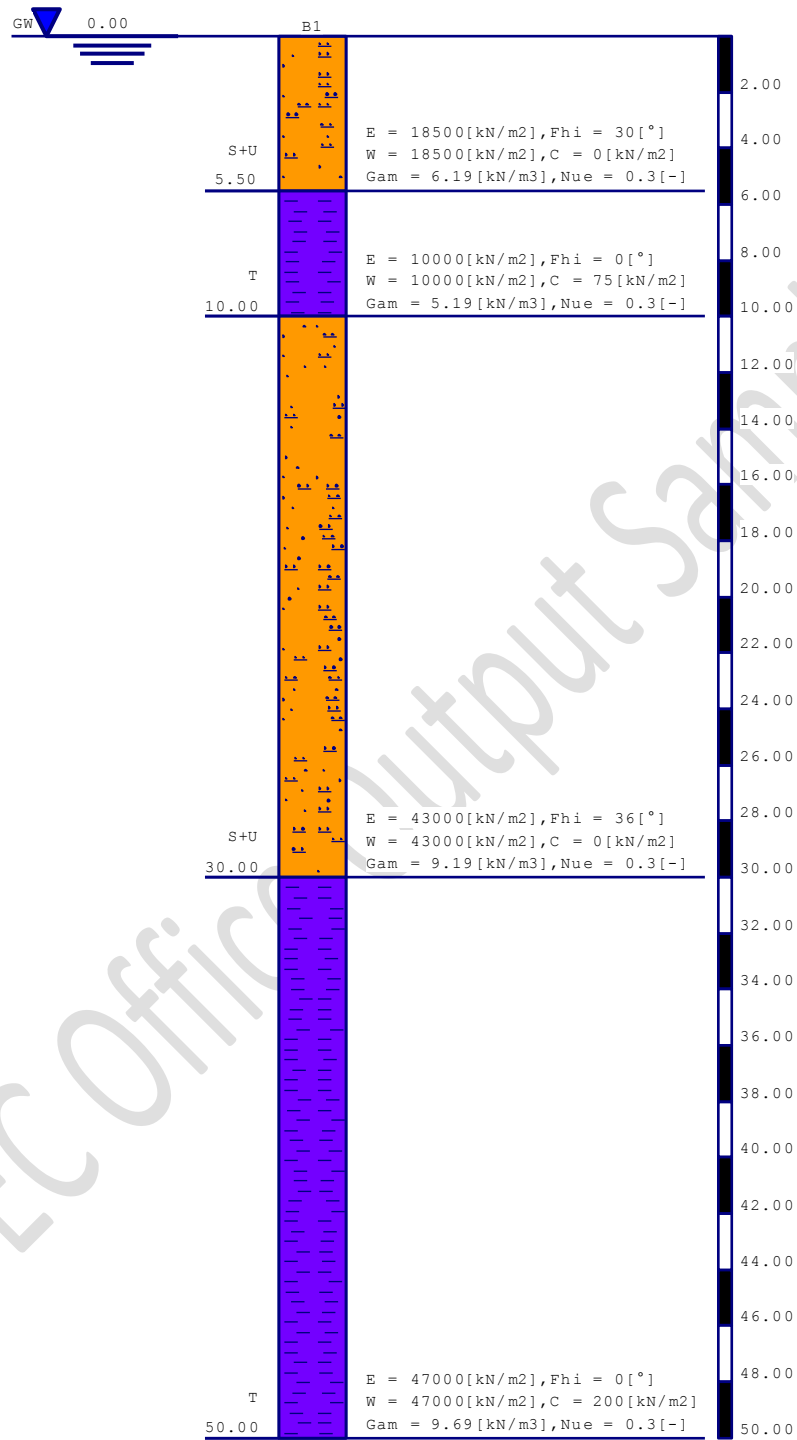

Boring Logs

GEOTEC

P. O. Box 465, Port-Said, Egypt* Tel. +2066-3609247

Scale 1:240

Title: Pile foundation analysis-right side

File: Pile foundation analysis_right side Date: 25/09/2010

Page No.:

Project: Tarut bridge, Qatif city- Saudi Arabia

Tarut Bridge - Analysis and design of foundation

Method (9) (Layered soil model)
Rigid free-standing raft

$y = 51.55$ [m]

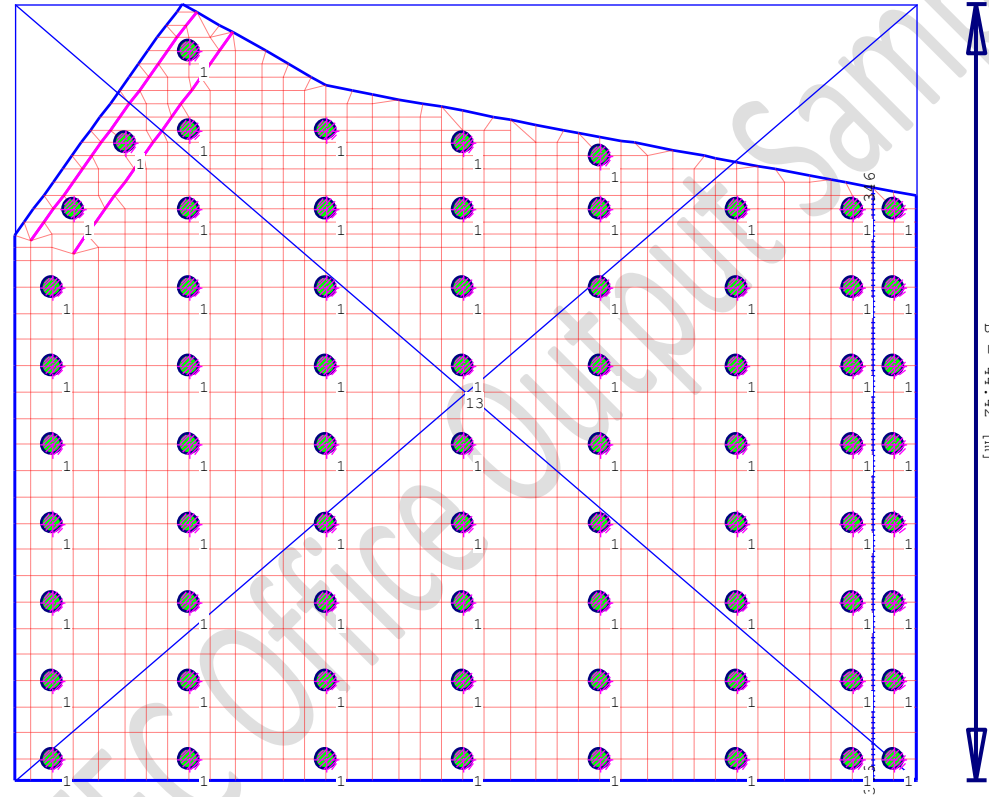
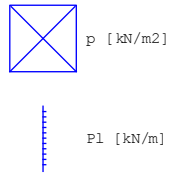

GEOTEC

P. O. Box 465, Port-Said, Egypt* Tel. +2066-3609247

Scale 1:380

File: Pile foundation analysis_right side

Page No.:

Title: Pile foundation analysis-right side

Date: 25/09/2010

Project: Tarut bridge, Qatif city- Saudi Arabia

Tarut Bridge - Analysis and design of foundation

Method (9) (Layered soil model)
Rigid free-standing raft

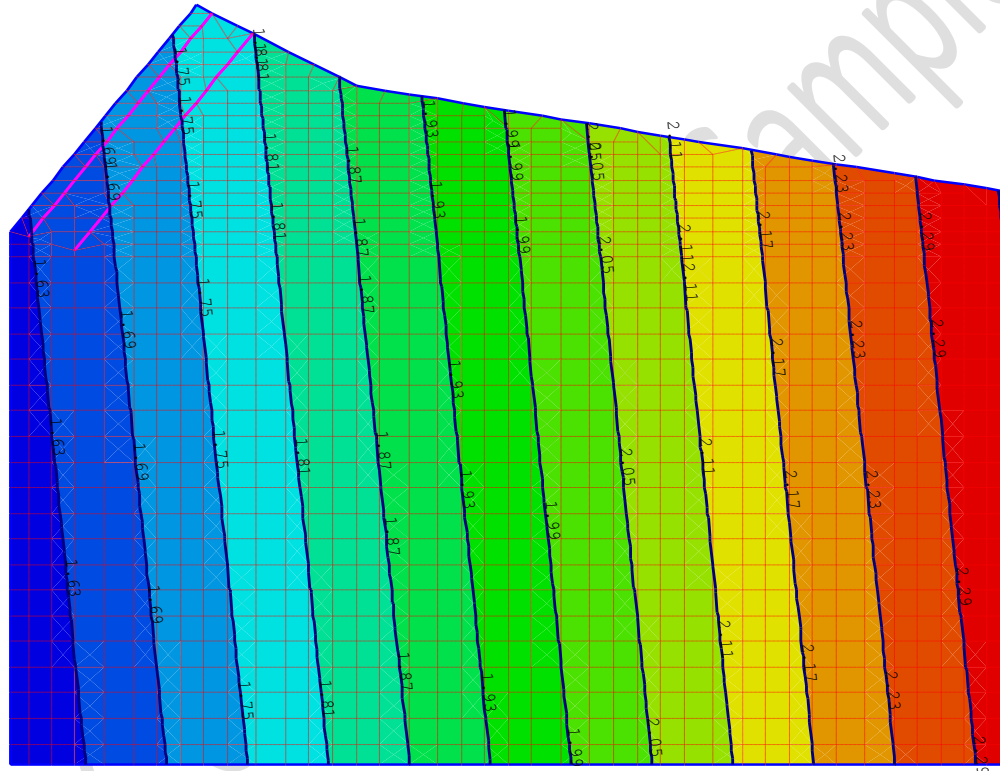
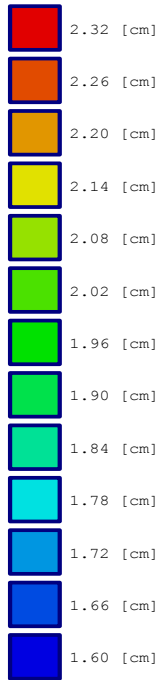

Settlements [cm]
Max. s = 2.36 at node 3, Min. s = 1.57 at node 1

GEOTEC Software

P. O. Box 465, Port-Said, Egypt* Tel. +2066-3609247

Scale 1:365

File: Pile foundation analysis_right side

Page No.:

Title: Pile foundation analysis-right side

Date: 25/09/2010

Project: Tarut bridge, Qatif city- Saudi Arabia

Tarut Bridge - Analysis and design of foundation

Method (9) (Layered soil model)
Rigid free-standing raft

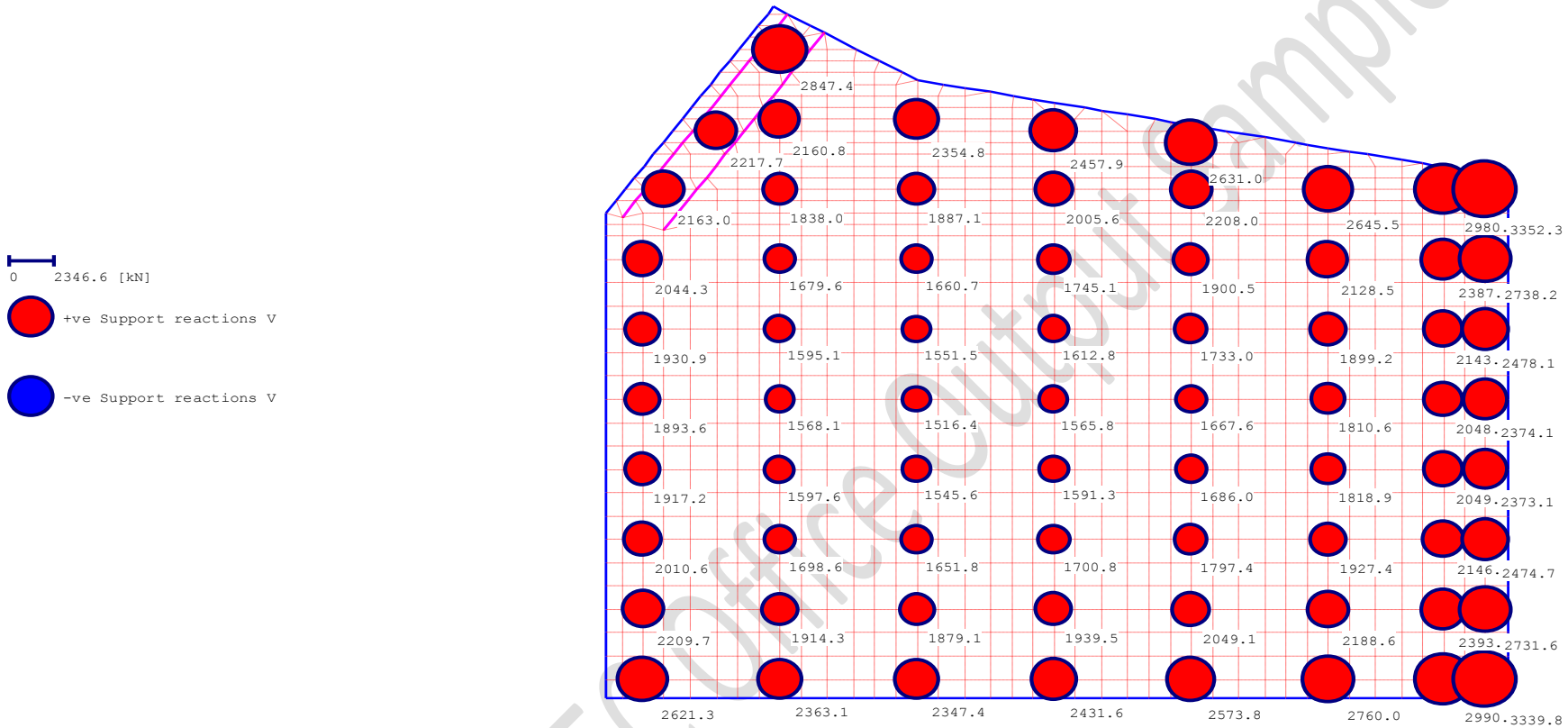

Support reactions V [kN]
Max. V = 3352.3 at node 1098, Min. V = 1516.4 at node 653, Sum = 148143.7

GEOTEC Software

P. O. Box 465, Port-Said, Egypt* Tel. +2066-3609247

Scale 1:365

File: Pile foundation analysis_right side

Page No.:

Title: Pile foundation analysis-right side

Date: 25/09/2010

Project: Tarut bridge, Qatif city- Saudi Arabia

11 Pile foundation design - right side

```
*****
                          Analysis of slab foundation
                          by the program package ELPLA
                          Version 9.2 SP1
*****
```

Title: Pile foundation design-right side
Date: 25/09/2010
Project: Tarut bridge, Qatif city- Saudi Arabia
File: Pile foundation design_right side

Calculation method:
Method (3)
Modulus of subgrade reaction is defined by the user

Program authors Prof. M. El Gendy/ Dr. A. El Gendy
GEOTEC Software Inc. PO Box 14001 Richmond Road PO, Calgary AB, Canada T3E 7Y7
www.geotecsoftware.com; geotec@geotecsoftware.com ; Tele.:+1(587) 332-3323

Tarut Bridge - Analysis and design of foundation

GEOTEC
PO Box 14001 Richmond Road PO, Calgary AB, Canada T3E 7Y7

Slab properties/ Foundation level/ Global coordinates Page

Title: Pile foundation design-right side
Date: 25/09/2010
Project: Tarut bridge, Qatif city- Saudi Arabia
File: Pile foundation design_right side

Analysis of slab foundation
by the program package ELPLA
Version 9.2 SP1

Calculation method:
Method (3)
Modulus of subgrade reaction is defined by the user

Slab properties/ Foundation level/ Global coordinates

Unit weight of slab material GB [kN/m3] = 25.0

Element groups (with the same thickness and material):

Group No.	E-Modulus of slab Ep [kN/m2]	Poisson's ratio Nue [-]	Slab thickness d [m]
1	2.4E+07	0.2	0.5
2	2.4E+07	0.2	1.36
3	2.4E+07	0.2	3.29
4	2.4E+07	0.2	1.69

Tarut Bridge - Analysis and design of foundation

PO Box 14001 Richmond Road PO, Calgary AB, Canada T3E 7Y7

Loads

Page

Title: Pile foundation design-right side
 Date: 25/09/2010
 Project: Tarut bridge, Qatif city- Saudi Arabia
 File: Pile foundation design_right side

Analysis of slab foundation
 by the program package ELPLA
 Version 9.2 SP1

Calculation method:
 Method (3)
 Modulus of subgrade reaction is defined by the user

Loading

Line loads:

Load No.	Load start value	Load end value	Load start	Load start	Load end	Load end
I	P1	P1	x1	y1	x2	y2
[-]	[kN/m]	[kN/m]	[m]	[m]	[m]	[m]
1	345.54	345.54	49.001	0	49.001	33.878

Distributed loads (Rectangle):

Load No.	Load value	Load start	Load start	Load end	Load end
I	P	x1	y1	x2	y2
[-]	[kN/m2]	[m]	[m]	[m]	[m]
1	13	0	44.421	51.552	0

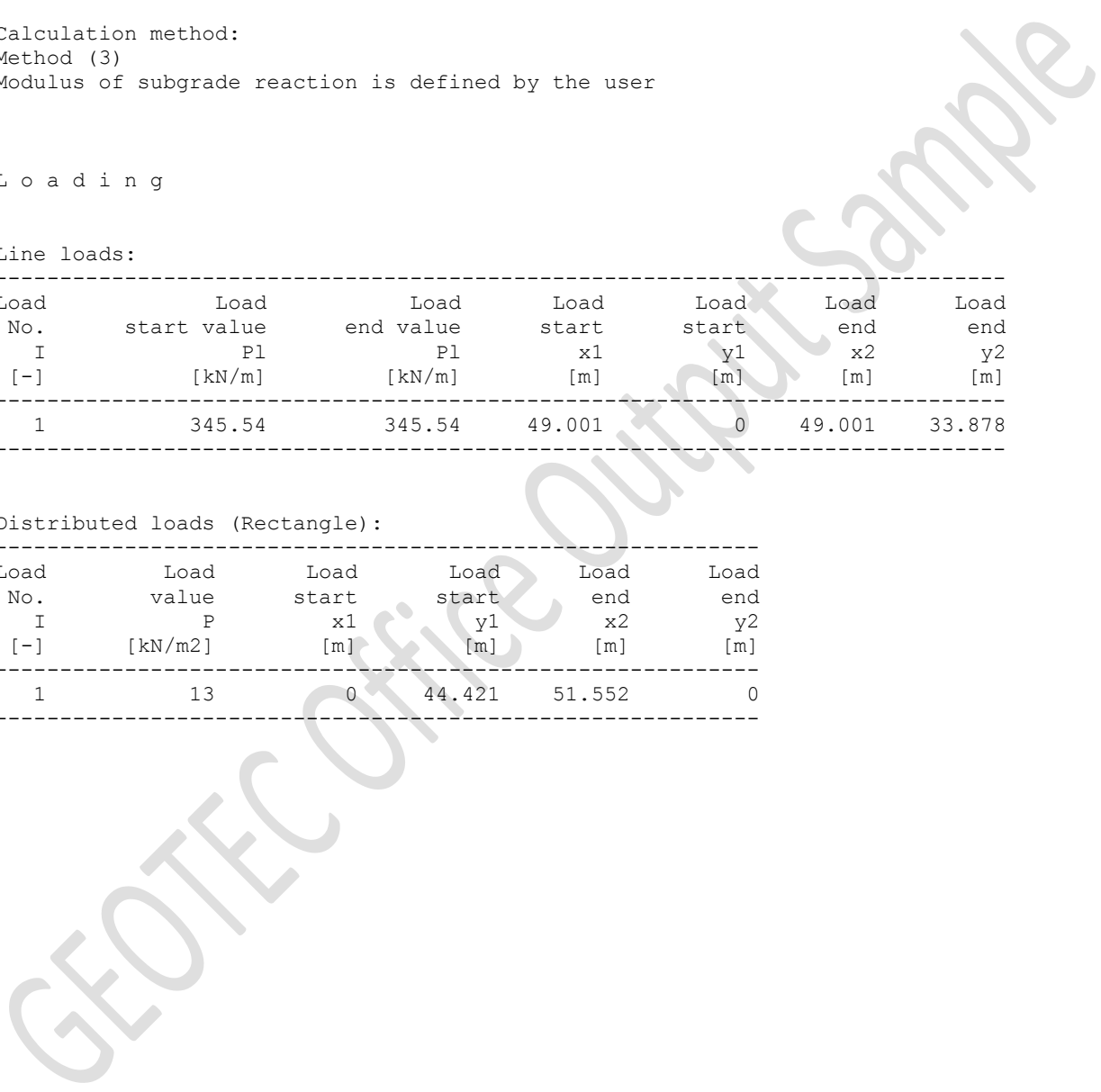

Tarut Bridge - Analysis and design of foundation

Loads

Page

Loading data:

Distribute column loads: (No)

Slab weight	Pe [kN]	= 44679.2
Force on slab	Pa [kN]	= 103464.5
Groundwater force	Pw [kN]	= 0.0
Total load ($P = Pe + Pa - Pw$)	P [kN]	= 148143.7
Groundwater pressure on raft	Qw [kN/m ²]	= 0.0
Average contact pressure	Qo [kN/m ²]	= 76.2

Sum Mx from loads	Mx [kN.m]	= -47718.5
Sum My from loads	My [kN.m]	= 587046.6

Eccentricity of loading in x-direction	ex [cm]	= 396.27
Eccentricity of loading in y-direction	ey [cm]	= -32.21

Moment of inertia of slab about x-Axis	Ix [m ⁴]	= 238867.70
Moment of inertia of slab about y-Axis	Iy [m ⁴]	= 414681.59
Product of inertia	Ixy [m ⁴]	= -25825.42
Area of the slab	A [m ²]	= 1942.88
Volume of the slab	V [m ³]	= 1787.17

GEOTEC

PO Box 14001 Richmond Road PO, Calgary AB, Canada T3E 7Y7

Tarut Bridge - Analysis and design of foundation

Data of reinforcement

Page

Title: Pile foundation design-right side
Date: 25/09/2010
Project: Tarut bridge, Qatif city- Saudi Arabia
File: Pile foundation design_right side

Analysis of slab foundation
by the program package ELPLA
Version 9.2 SP1

Calculation method:
Method (3)
Modulus of subgrade reaction is defined by the user

Data of reinforcement (Design for flexural moment)

Design Code
Concrete grade C 300
Steel Grade S 36/52

Compressive strength f_c [kN/m²] = 10500
Tensile strength f_s [kN/m²] = 200000

Concrete cover+ 1/2 bar diameter
X-direction top d_{1x} [cm] = 7
X-direction bottom d_{2x} [cm] = 7
Y-direction top d_{1y} [cm] = 7
Y-direction bottom d_{2y} [cm] = 7

GEOTEC Office Output Sample

GEOTEC

PO Box 14001 Richmond Road PO, Calgary AB, Canada T3E 7Y7

Data of piles

Page

Tarut Bridge - Analysis and design of foundation

Title: Pile foundation design-right side
 Date: 25/09/2010
 Project: Tarut bridge, Qatif city- Saudi Arabia
 File: Pile foundation design_right side

Analysis of slab foundation
 by the program package ELPLA
 Version 9.2 SP1

Calculation method:
 Method (3)
 Modulus of subgrade reaction is defined by the user

File groups:

Group No. I [-]	Pile diameter D [m]	Pile length L [m]	Pile stiffness kz [kN/m]
1	1.20	28.00	162814.0
2	1.20	28.00	137248.0
3	1.20	28.00	124111.0
4	1.20	28.00	118346.0
5	1.20	28.00	116172.0
6	1.20	28.00	117738.0
7	1.20	28.00	124652.0
8	1.20	28.00	130301.0
9	1.20	28.00	129690.0
10	1.20	28.00	160870.0
11	1.20	28.00	137390.0
12	1.20	28.00	111297.0
13	1.20	28.00	98185.0
14	1.20	28.00	91816.0
15	1.20	28.00	90121.0
16	1.20	28.00	91149.0
17	1.20	28.00	95977.0
18	1.20	28.00	104432.0
19	1.20	28.00	122079.0
20	1.20	28.00	128273.0
21	1.20	28.00	102125.0
22	1.20	28.00	89772.0
23	1.20	28.00	83546.0
24	1.20	28.00	81527.0
25	1.20	28.00	83414.0
26	1.20	28.00	88807.0
27	1.20	28.00	100914.0
28	1.20	28.00	125255.0
29	1.20	28.00	125340.0
30	1.20	28.00	99462.0
31	1.20	28.00	86776.0
32	1.20	28.00	81189.0
33	1.20	28.00	79482.0
34	1.20	28.00	81868.0
35	1.20	28.00	88136.0
36	1.20	28.00	100784.0
37	1.20	28.00	123513.0
38	1.20	28.00	124942.0
39	1.20	28.00	99471.0
40	1.20	28.00	86831.0

Continue of table at next page

GEOTEC
 PO Box 14001 Richmond Road PO, Calgary AB, Canada T3E 7Y7

Data of piles

Page

Tarut Bridge - Analysis and design of foundation

Continue of table

Group No.	Pile diameter	Pile length	Pile stiffness
I	D	L	kz
[-]	[m]	[m]	[kN/m]
41	1.20	28.00	81058.0
42	1.20	28.00	80173.0
43	1.20	28.00	82919.0
44	1.20	28.00	90933.0
45	1.20	28.00	105143.0
46	1.20	28.00	125286.0
47	1.20	28.00	127189.0
48	1.20	28.00	100394.0
49	1.20	28.00	88413.0
50	1.20	28.00	83055.0
51	1.20	28.00	82676.0
52	1.20	28.00	86327.0
53	1.20	28.00	96312.0
54	1.20	28.00	119706.0
55	1.20	28.00	131722.0
56	1.20	28.00	105458.0
57	1.20	28.00	94154.0
58	1.20	28.00	89890.0
59	1.20	28.00	89454.0
60	1.20	28.00	93607.0
61	1.20	28.00	103817.0
62	1.20	28.00	129013.0
63	1.20	28.00	145209.0
64	1.20	28.00	118251.0
65	1.20	28.00	107130.0
66	1.20	28.00	102289.0
67	1.20	28.00	102332.0
68	1.20	28.00	106356.0
69	1.20	28.00	117519.0
70	1.20	28.00	143261.0

File locations and groups:

File No.	Node No.	X-coord.	Y-coord.	Group No.
[-]	[-]	[m]	[m]	[-]
1	173	2.12	1.20	1
2	179	9.95	1.20	11
3	185	17.78	1.20	20
4	191	25.61	1.20	29
5	197	33.44	1.20	38
6	203	41.27	1.20	47
7	208	47.85	1.20	55
8	210	50.25	1.20	63
9	290	2.12	5.70	2
10	296	9.95	5.70	12
11	302	17.78	5.70	21
12	308	25.61	5.70	30
13	314	33.44	5.70	39
14	320	41.27	5.70	48
15	325	47.85	5.70	56
16	327	50.25	5.70	64
17	407	2.12	10.20	3
18	413	9.95	10.20	13

Continue of table at next page

GEOTEC

PO Box 14001 Richmond Road PO, Calgary AB, Canada T3E 7Y7

Data of piles

Page

Continue of table

Tarut Bridge - Analysis and design of foundation

File No. [-]	Node No. [-]	X-coord. [m]	Y-coord. [m]	Group No. [-]
19	419	17.78	10.20	22
20	425	25.61	10.20	31
21	431	33.44	10.20	40
22	437	41.27	10.20	49
23	442	47.85	10.20	57
24	444	50.25	10.20	65
25	524	2.12	14.70	4
26	530	9.95	14.70	14
27	536	17.78	14.70	23
28	542	25.61	14.70	32
29	548	33.44	14.70	41
30	554	41.27	14.70	50
31	559	47.85	14.70	58
32	561	50.25	14.70	66
33	641	2.12	19.20	5
34	647	9.95	19.20	15
35	653	17.78	19.20	24
36	659	25.61	19.20	33
37	665	33.44	19.20	42
38	671	41.27	19.20	51
39	676	47.85	19.20	59
40	678	50.25	19.20	67
41	758	2.12	23.70	6
42	764	9.95	23.70	16
43	770	17.78	23.70	25
44	776	25.61	23.70	34
45	782	33.44	23.70	43
46	788	41.27	23.70	52
47	793	47.85	23.70	60
48	795	50.25	23.70	68
49	875	2.12	28.20	7
50	881	9.95	28.20	17
51	887	17.78	28.20	26
52	893	25.61	28.20	35
53	899	33.44	28.20	44
54	905	41.27	28.20	53
55	910	47.85	28.20	61
56	912	50.25	28.20	69
57	1098	50.25	32.70	70
58	1096	47.85	32.70	62
59	1091	41.27	32.70	54
60	1085	33.44	32.70	45
61	1079	25.61	32.70	36
62	1073	17.78	32.70	27
63	1067	9.95	32.70	18
64	1063	3.32	32.70	8
65	1236	9.95	37.20	19
66	1242	17.78	37.20	28
67	1288	9.95	41.70	10
68	1215	6.32	36.45	9
69	1229	25.61	36.45	37
70	1212	33.44	35.70	46

File material:

Unit weight of pile concrete GP [kN/m³] = 30.00

Modulus of elasticity of pile Ep [kN/m²] = 24000000.00

(The 5 m pile length above the bed level is considered by assuming an equivalent unit weight of pile concrete)

GEOTEC

PO Box 14001 Richmond Road PO, Calgary AB, Canada T3E 7Y7

Support reactions

Page

Title: Pile foundation design-right side

Date: 25/09/2010

Tarut Bridge - Analysis and design of foundation

Project: Tarut bridge, Qatif city- Saudi Arabia
 File: Pile foundation design_right side

Analysis of slab foundation
 by the program package ELPLA
 Version 9.2 SP1

Calculation method:
 Method (3)
 Modulus of subgrade reaction is defined by the user

Support reactions

Node No.	Load-V	Moment-Y	Moment-X
I	V	My	Mx
[-]	[kN]	[kN.m]	[kN.m]
173	1630.9	0.0	0.0
179	1995.3	0.0	0.0
185	1955.9	0.0	0.0
191	1940.0	0.0	0.0
197	1926.5	0.0	0.0
203	2250.4	0.0	0.0
208	2622.3	0.0	0.0
210	2620.8	0.0	0.0
290	1748.8	0.0	0.0
296	2040.9	0.0	0.0
302	2005.5	0.0	0.0
308	1991.3	0.0	0.0
314	1981.6	0.0	0.0
320	2180.1	0.0	0.0
325	2370.7	0.0	0.0
327	2440.4	0.0	0.0
407	1828.5	0.0	0.0
413	2077.6	0.0	0.0
419	2059.6	0.0	0.0
425	2033.1	0.0	0.0
431	2020.9	0.0	0.0
437	2174.2	0.0	0.0
442	2309.2	0.0	0.0
444	2430.0	0.0	0.0
524	1878.8	0.0	0.0
530	2094.4	0.0	0.0
536	2082.2	0.0	0.0
542	2062.2	0.0	0.0
548	2039.4	0.0	0.0
554	2169.1	0.0	0.0
559	2308.1	0.0	0.0
561	2437.1	0.0	0.0
641	1885.0	0.0	0.0
647	2101.8	0.0	0.0
653	2084.1	0.0	0.0
659	2058.0	0.0	0.0
665	2046.0	0.0	0.0
671	2171.8	0.0	0.0

Continue of table at next page

GEOTEC
 PO Box 14001 Richmond Road PO, Calgary AB, Canada T3E 7Y7

Support reactions

Page

Continue of table

Tarut Bridge - Analysis and design of foundation

Node No.	Load-V	Moment-Y	Moment-X
I	V	My	Mx
[-]	[kN]	[kN.m]	[kN.m]
676	2303.0	0.0	0.0
678	2443.9	0.0	0.0
758	1856.2	0.0	0.0
764	2074.8	0.0	0.0
770	2079.9	0.0	0.0
776	2042.1	0.0	0.0
782	2021.1	0.0	0.0
788	2168.2	0.0	0.0
793	2315.6	0.0	0.0
795	2431.4	0.0	0.0
875	1790.7	0.0	0.0
881	2032.3	0.0	0.0
887	2058.7	0.0	0.0
893	1995.7	0.0	0.0
899	1978.2	0.0	0.0
905	2202.6	0.0	0.0
910	2372.5	0.0	0.0
912	2462.6	0.0	0.0
1063	1719.6	0.0	0.0
1067	1951.0	0.0	0.0
1073	2083.3	0.0	0.0
1079	1942.1	0.0	0.0
1085	1871.8	0.0	0.0
1091	2400.7	0.0	0.0
1096	2638.4	0.0	0.0
1098	2653.8	0.0	0.0
1212	1841.8	0.0	0.0
1215	1709.8	0.0	0.0
1229	1991.4	0.0	0.0
1236	1897.2	0.0	0.0
1242	2253.5	0.0	0.0
1288	1932.1	0.0	0.0
Sum. V	147568.1		

GEOTEC Office Output Sample

GEOTEC
PO Box 14001 Richmond Road PO, Calgary AB, Canada T3E 7Y7

File results

Page

Title: Pile foundation design-right side
 Date: 25/09/2010
 Project: Tarut bridge, Qatif city- Saudi Arabia
 File: Pile foundation design_right side

Tarut Bridge - Analysis and design of foundation

Analysis of slab foundation
by the program package ELPLA
Version 9.2 SP1

Calculation method:

Method (3)

Modulus of subgrade reaction is defined by the user

File results

Value of total load (including own wt.)		Po	[kN] = 148143.7
Total pile loads		PL	[kN] = 147568.1
Bearing factor of piled raft		Alfa-Kpp	[%] = 99.61

File loads and displacements

Pile No.	pile load	Settlement	Soil stiffness
I	Fr	Sr	ks
[-]	[kN]	[cm]	[kN/m]
1	1630.9	1.00	162814.0
2	1995.3	1.45	137390.0
3	1955.9	1.52	128273.0
4	1940.0	1.55	125340.0
5	1926.5	1.54	124942.0
6	2250.4	1.77	127189.0
7	2622.3	1.99	131722.0
8	2620.8	1.80	145209.0
9	1748.8	1.27	137248.0
10	2040.9	1.83	111297.0
11	2005.5	1.96	102125.0
12	1991.3	2.00	99462.0
13	1981.6	1.99	99471.0
14	2180.1	2.17	100394.0
15	2370.7	2.25	105458.0
16	2440.4	2.06	118251.0
17	1828.5	1.47	124111.0
18	2077.6	2.12	98185.0
19	2059.6	2.29	89772.0
20	2033.1	2.34	86776.0
21	2020.9	2.33	86831.0
22	2174.2	2.46	88413.0
23	2309.2	2.45	94154.0
24	2430.0	2.27	107130.0
25	1878.8	1.59	118346.0
26	2094.4	2.28	91816.0
27	2082.2	2.49	83546.0
28	2062.2	2.54	81189.0
29	2039.4	2.52	81058.0
30	2169.1	2.61	83055.0
31	2308.1	2.57	89890.0
32	2437.1	2.38	102289.0
33	1885.0	1.62	116172.0

Continue of table at next page

GEOTEC
PO Box 14001 Richmond Road PO, Calgary AB, Canada T3E 7Y7

File results

Page

Continue of table

Pile No.	pile load	Settlement	Soil stiffness
----------	-----------	------------	----------------

Tarut Bridge - Analysis and design of foundation

I	Fr	Sr	ks
[-]	[kN]	[cm]	[kN/m]
34	2101.8	2.33	90121.0
35	2084.1	2.56	81527.0
36	2058.0	2.59	79482.0
37	2046.0	2.55	80173.0
38	2171.8	2.63	82676.0
39	2303.0	2.57	89454.0
40	2443.9	2.39	102332.0
41	1856.2	1.58	117738.0
42	2074.8	2.28	91149.0
43	2079.9	2.49	83414.0
44	2042.1	2.49	81868.0
45	2021.1	2.44	82919.0
46	2168.2	2.51	86327.0
47	2315.6	2.47	93607.0
48	2431.4	2.29	106356.0
49	1790.7	1.44	124652.0
50	2032.3	2.12	95977.0
51	2058.7	2.32	88807.0
52	1995.7	2.26	88136.0
53	1978.2	2.18	90933.0
54	2202.6	2.29	96312.0
55	2372.5	2.29	103817.0
56	2462.6	2.10	117519.0
57	2653.8	1.85	143261.0
58	2638.4	2.05	129013.0
59	2400.7	2.01	119706.0
60	1871.8	1.78	105143.0
61	1942.1	1.93	100784.0
62	2083.3	2.06	100914.0
63	1951.0	1.87	104432.0
64	1719.6	1.32	130301.0
65	1897.2	1.55	122079.0
66	2253.5	1.80	125255.0
67	1932.1	1.20	160870.0
68	1709.8	1.32	129690.0
69	1991.4	1.61	123513.0
70	1841.8	1.47	125286.0

Tarut Bridge - Analysis and design of foundation

Node No.	Load value	X-coord.	Y-coord.	Pile diameter	Punching shear stress	Stress on the column	Area of critical section of punching shear	Perimeter of critical section of punching shear	Effective depth of the section of punching shear	Punching shear stress ratio
I [-]	Pc [kN]	Xc [m]	Yc [m]	a [m]	Qp [kN/m ²]	Qo [kN/m ²]	PA [m ²]	AL [m]	Dp [m]	Rpa [%]
1	1630.9	2.12	1.2	1.2	149.4	46.9	4.74	7.31	1.29	3.35
2	1995.3	9.95	1.2	1.2	188	46.9	4.74	7.31	1.29	2.66
3	1955.9	17.78	1.2	1.2	183.8	46.9	4.74	7.31	1.29	2.72
4	1940	25.61	1.2	1.2	182.1	46.9	4.74	7.31	1.29	2.75
5	1926.5	33.44	1.2	1.2	180.7	46.9	4.74	7.31	1.29	2.77
6	2250.4	41.27	1.2	1.2	215.1	46.9	4.74	7.31	1.29	2.32
7	2622.3	47.85	1.2	1.2	55.4	75	12.43	9.48	3.22	9.03
8	2620.8	50.25	1.2	1.2	227.2	56.5	5.84	6.22	1.62	2.2
9	1748.8	2.12	5.7	1.2	152.2	46.9	4.75	7.77	1.29	3.28
10	2040.9	9.95	5.7	1.2	181.4	46.9	4.75	7.77	1.29	2.76
11	2005.5	17.78	5.7	1.2	177.8	46.9	4.75	7.77	1.29	2.81
12	1991.3	25.61	5.7	1.2	176.4	46.9	4.75	7.77	1.29	2.83
13	1981.6	33.44	5.7	1.2	175.4	46.9	4.75	7.77	1.29	2.85
14	2180.1	41.27	5.7	1.2	195.2	46.9	4.75	7.77	1.29	2.56
15	2370.7	47.85	5.7	1.2	27.5	76.8	14.95	13.8	3.22	18.17
16	2440.4	50.25	5.7	1.2	168.5	56.5	6.03	7.69	1.62	2.97
17	1828.5	2.12	10.2	1.2	160.2	46.9	4.75	7.77	1.29	3.12
18	2077.6	9.95	10.2	1.2	185	46.9	4.75	7.77	1.29	2.7
19	2059.6	17.78	10.2	1.2	183.2	46.9	4.75	7.77	1.29	2.73
20	2033.1	25.61	10.2	1.2	180.6	46.9	4.75	7.77	1.29	2.77
21	2020.9	33.44	10.2	1.2	179.4	46.9	4.75	7.77	1.29	2.79
22	2174.2	41.27	10.2	1.2	194.6	46.9	4.75	7.77	1.29	2.57
23	2309.2	47.85	10.2	1.2	26.1	76.8	14.95	13.8	3.22	19.13

Tarut Bridge - Analysis and design of foundation

Node No.	Load value	X-coord.	Y-coord.	Pile diameter	Punching shear stress	Stress on the column	Area of critical section of punching shear	Perimeter of critical section of punching shear	Effective depth of the section of punching shear	Punching shear stress ratio
I [-]	Pc [kN]	Xc [m]	Yc [m]	a [m]	Qp [kN/m ²]	Qo [kN/m ²]	PA [m ²]	AL [m]	Dp [m]	Rpa [%]
24	2430	50.25	10.2	1.2	167.7	56.5	6.03	7.69	1.62	2.98
25	1878.8	2.12	14.7	1.2	165.2	46.9	4.75	7.77	1.29	3.03
26	2094.4	9.95	14.7	1.2	186.7	46.9	4.75	7.77	1.29	2.68
27	2082.2	17.78	14.7	1.2	185.5	46.9	4.75	7.77	1.29	2.7
28	2062.2	25.61	14.7	1.2	183.5	46.9	4.75	7.77	1.29	2.73
29	2039.4	33.44	14.7	1.2	181.2	46.9	4.75	7.77	1.29	2.76
30	2169.1	41.27	14.7	1.2	194.1	46.9	4.75	7.77	1.29	2.58
31	2308.1	47.85	14.7	1.2	26.1	76.8	14.95	13.8	3.22	19.15
32	2437.1	50.25	14.7	1.2	168.3	56.5	6.03	7.69	1.62	2.97
33	1885	2.12	19.2	1.2	165.8	46.9	4.75	7.77	1.29	3.02
34	2101.8	9.95	19.2	1.2	187.4	46.9	4.75	7.77	1.29	2.67
35	2084.1	17.78	19.2	1.2	185.7	46.9	4.75	7.77	1.29	2.69
36	2058	25.61	19.2	1.2	183.1	46.9	4.75	7.77	1.29	2.73
37	2046	33.44	19.2	1.2	181.9	46.9	4.75	7.77	1.29	2.75
38	2171.8	41.27	19.2	1.2	194.4	46.9	4.75	7.77	1.29	2.57
39	2303	47.85	19.2	1.2	26	76.8	14.95	13.8	3.22	19.23
40	2443.9	50.25	19.2	1.2	168.8	56.5	6.03	7.69	1.62	2.96
41	1856.2	2.12	23.7	1.2	162.9	46.9	4.75	7.77	1.29	3.07
42	2074.8	9.95	23.7	1.2	184.7	46.9	4.75	7.77	1.29	2.71
43	2079.9	17.78	23.7	1.2	185.2	46.9	4.75	7.77	1.29	2.7
44	2042.1	25.61	23.7	1.2	181.5	46.9	4.75	7.77	1.29	2.76
45	2021.1	33.44	23.7	1.2	179.4	46.9	4.75	7.77	1.29	2.79
46	2168.2	41.27	23.7	1.2	194	46.9	4.75	7.77	1.29	2.58
47	2315.6	47.85	23.7	1.2	26.3	76.8	14.95	13.8	3.22	19.02

Tarut Bridge - Analysis and design of foundation

Node No.	Load value	X-coord.	Y-coord.	Pile diameter	Punching shear stress	Stress on the column	Area of critical section of punching shear	Perimeter of critical section of punching shear	Effective depth of the section of punching shear	Punching shear stress ratio
I [-]	Pc [kN]	Xc [m]	Yc [m]	a [m]	Qp [kN/m ²]	Qo [kN/m ²]	PA [m ²]	AL [m]	Dp [m]	Rpa [%]
48	2431.4	50.25	23.7	1.2	167.8	56.5	6.03	7.69	1.62	2.98
49	1790.7	2.12	28.2	1.2	156.4	46.9	4.75	7.77	1.29	3.2
50	2032.3	9.95	28.2	1.2	180.5	46.9	4.75	7.77	1.29	2.77
51	2058.7	17.78	28.2	1.2	183.1	46.9	4.75	7.77	1.29	2.73
52	1995.7	25.61	28.2	1.2	176.8	46.9	4.75	7.77	1.29	2.83
53	1978.2	33.44	28.2	1.2	175.1	46.9	4.75	7.77	1.29	2.86
54	2202.6	41.27	28.2	1.2	197.5	46.9	4.75	7.77	1.29	2.53
55	2372.5	47.85	28.2	1.2	27.6	76.8	14.95	13.8	3.22	18.14
56	2462.6	50.25	28.2	1.2	170.3	56.5	6.03	7.69	1.62	2.94
57	2653.8	50.25	32.7	1.2	230.5	56.6	5.45	6.28	1.62	2.17
58	2638.4	47.85	32.7	1.2	50.3	75.1	13.18	10.18	3.22	9.94
59	2400.7	41.27	32.7	1.2	217.2	46.9	4.75	7.77	1.29	2.3
60	1871.8	33.44	32.7	1.2	164.5	46.9	4.75	7.77	1.29	3.04
61	1942.1	25.61	32.7	1.2	171.5	46.9	4.75	7.77	1.29	2.92
62	2083.3	17.78	32.7	1.2	185.6	46.9	4.75	7.77	1.29	2.69
63	1951	9.95	32.7	1.2	172.4	46.9	4.75	7.77	1.29	2.9
64	1719.6	3.32	32.7	1.2	150.1	45.1	4.75	7.77	1.29	3.33
65	1897.2	9.95	37.2	1.2	166.8	47	4.75	7.78	1.29	3
66	2253.5	17.78	37.2	1.2	202.6	46.9	4.75	7.77	1.29	2.47
67	1932.1	9.95	41.7	1.2	171	45.8	4.75	7.77	1.29	2.92
68	1709.8	6.32	36.45	1.2	148.5	46.6	4.75	7.77	1.29	3.37
69	1991.4	25.61	36.45	1.2	176.4	46.9	4.75	7.77	1.29	2.83
70	1841.8	33.44	35.7	1.2	189.5	46.9	4.65	6.64	1.29	2.64

Tarut Bridge - Analysis and design of foundation

Method (2)
Modulus of subgrade reaction is defined by the user

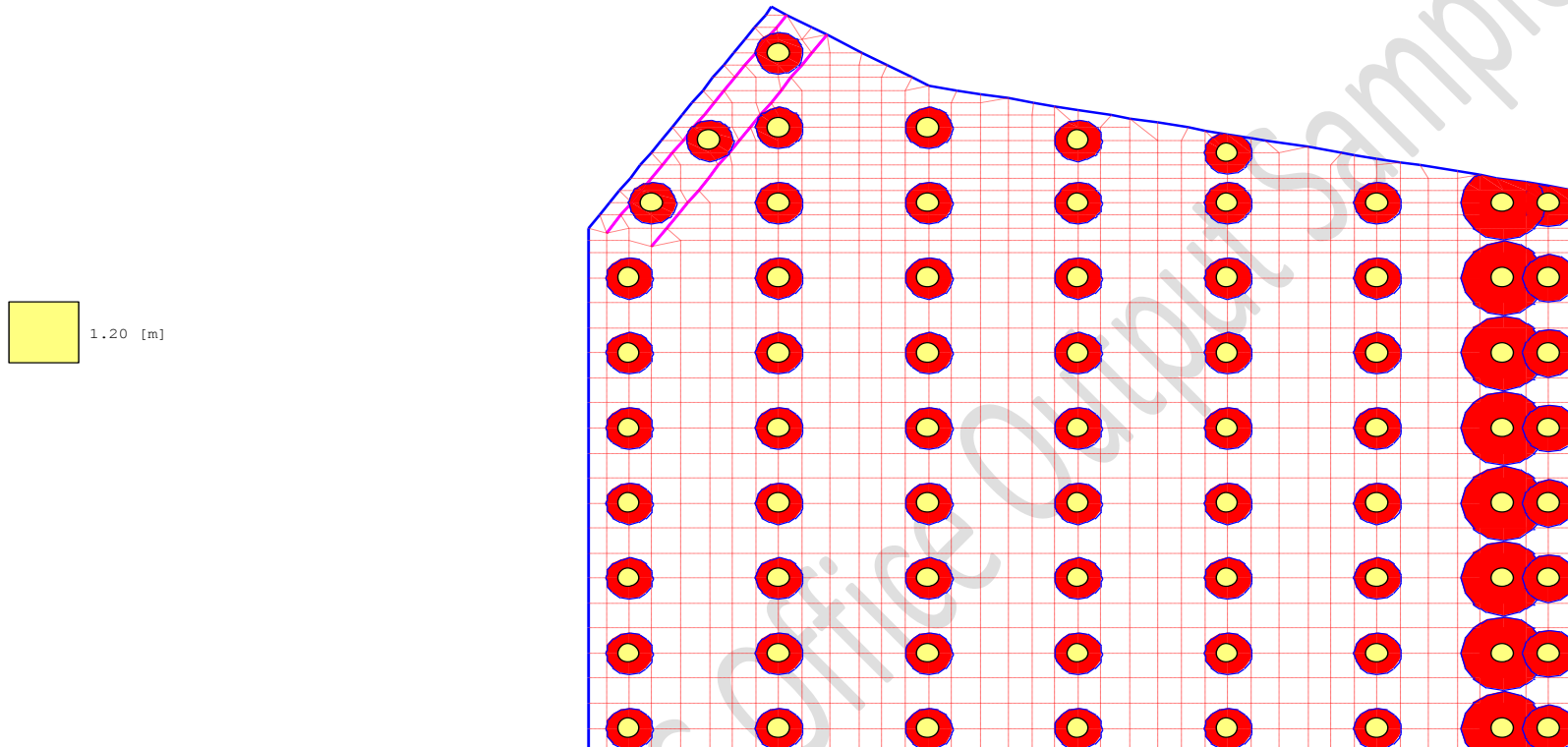

Punching shear stress ratio R_{pa} [%]
Max. R_{pa} = 19.23 at column 39, Min. R_{pa} = 2.17 at column 57

GEO-TEC Software

P. O. Box 465, Port-Said, Egypt* Tel. +2066-3609247

Scale 1:365

File: Pile foundation design_right side

Page No.:

Title: Pile foundation design-right side

Date: 25/09/2010

Project: Tarut bridge, Qatif city- Saudi Arabia

Tarut Bridge - Analysis and design of foundation

Method (2)

Modulus of subgrade reaction is defined by the user

$y = 51.55$ [m]

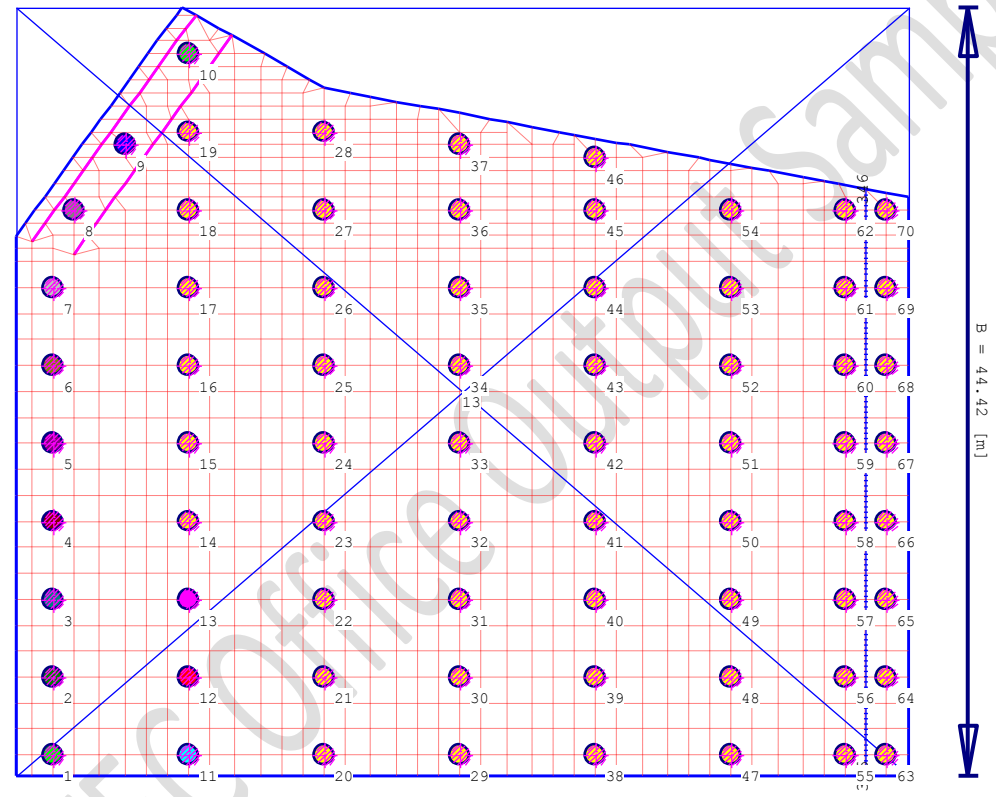
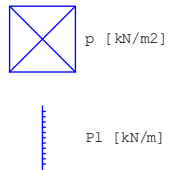

Loads

GEOTEC

P. O. Box 465, Port-Said, Egypt* Tel. +2066-3609247

Scale 1:380

File: Pile foundation design_right side

Page No. :

Title: Pile foundation design-right side

Date: 25/09/2010

Project: Tarut bridge, Qatif city- Saudi Arabia

Tarut Bridge - Analysis and design of foundation

Method (2)
Modulus of subgrade reaction is defined by the user

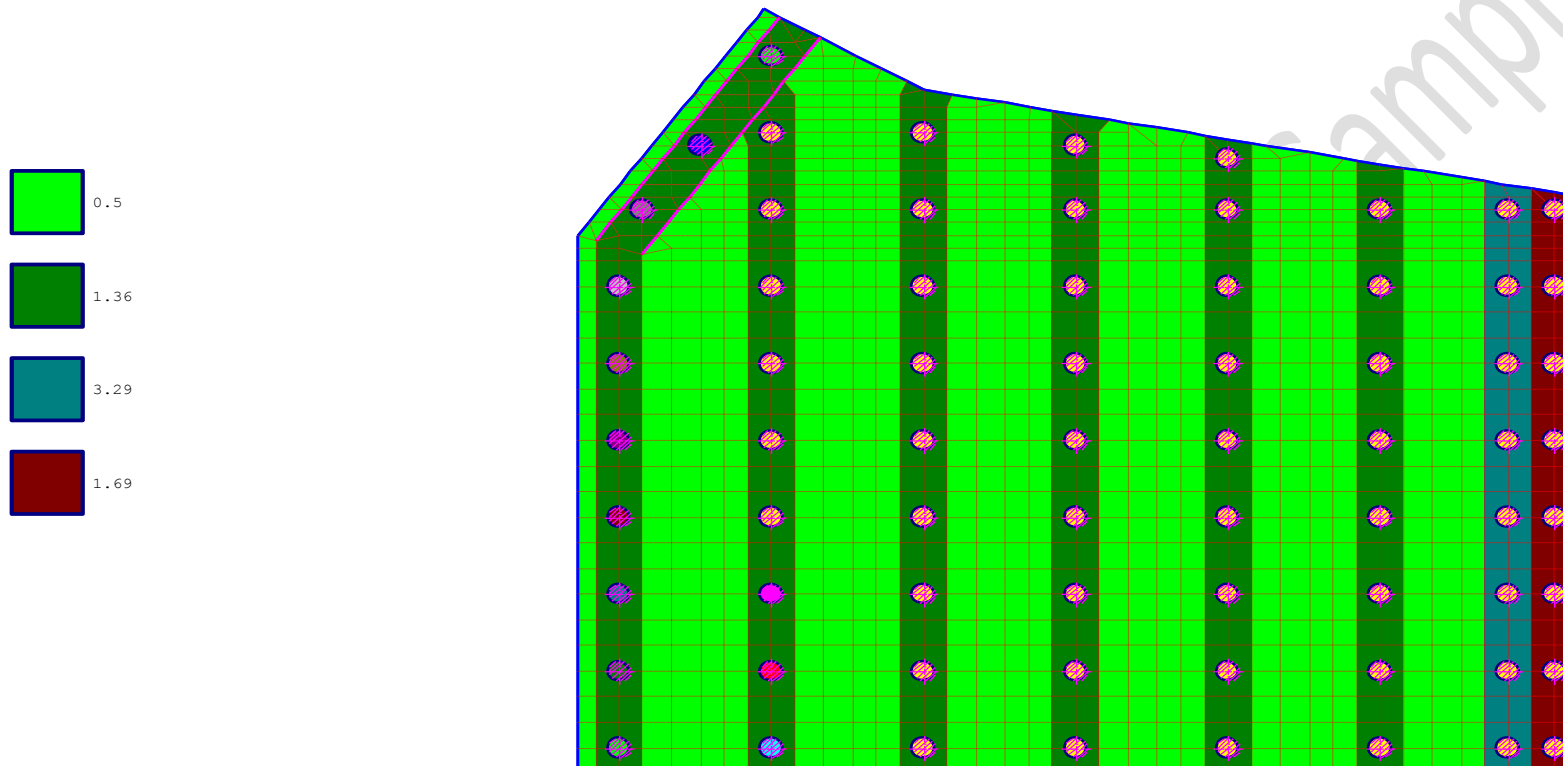

Slab thickness [m]
No. of element groups = 4

GEOTEC Software

P. O. Box 465, Port-Said, Egypt* Tel. +2066-3609247

Scale 1:365

File: Pile foundation design_right side

Page No.:

Title: Pile foundation design-right side

Date: 25/09/2010

Project: Tarut bridge, Qatif city- Saudi Arabia

Tarut Bridge - Analysis and design of foundation

Method (2)
Modulus of subgrade reaction is defined by the user

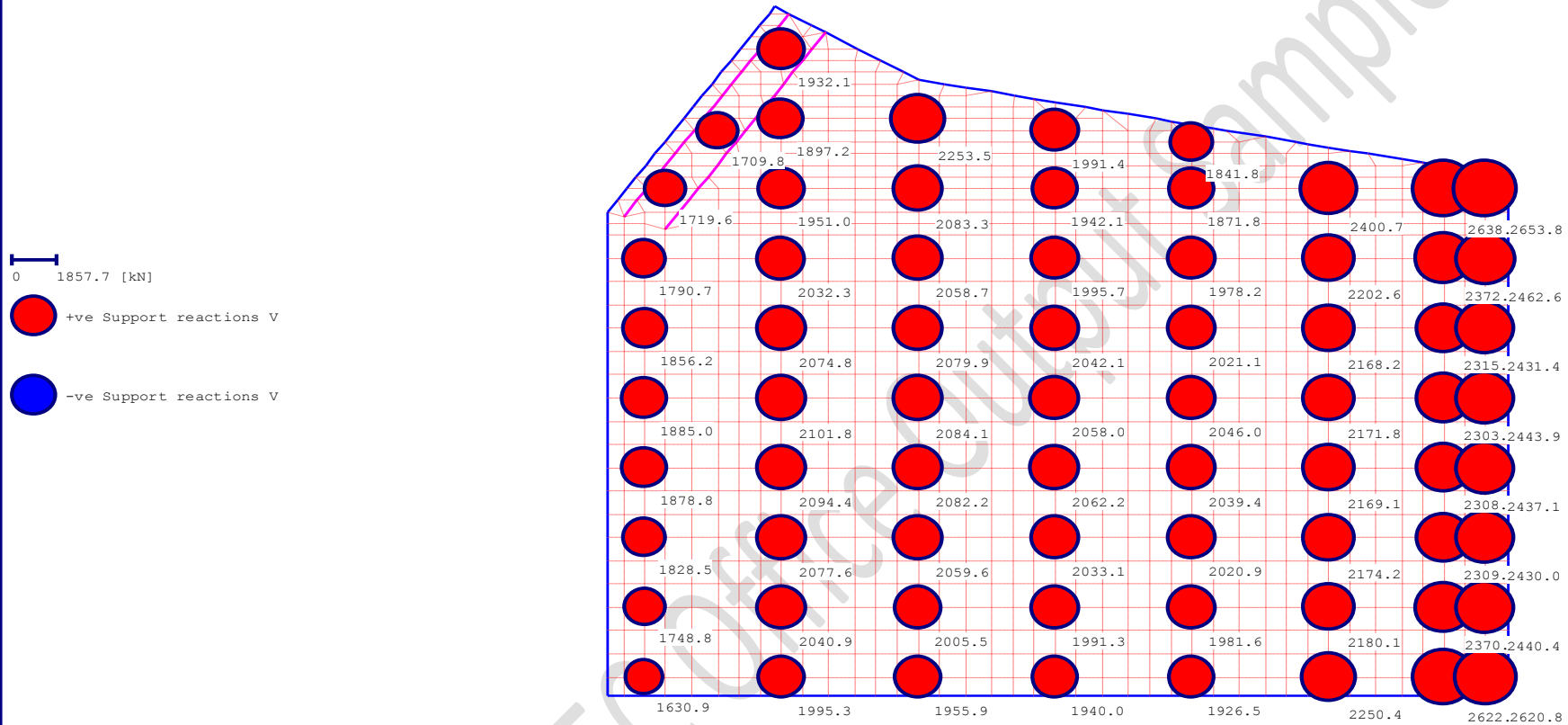

Support reactions V [kN]
Max. V = 2653.8 at node 1098, Min. V = 1630.9 at node 173, Sum = 147568.1

GEOTEC Software
P. O. Box 465, Port-Said, Egypt* Tel. +2066-3609247

Scale 1:365
File: Pile foundation design_right side
Page No.:

Title: Pile foundation design-right side
Date: 25/09/2010
Project: Tarut bridge, Qatif city- Saudi Arabia

Tarut Bridge - Analysis and design of foundation

Method (2)

Modulus of subgrade reaction is defined by the user

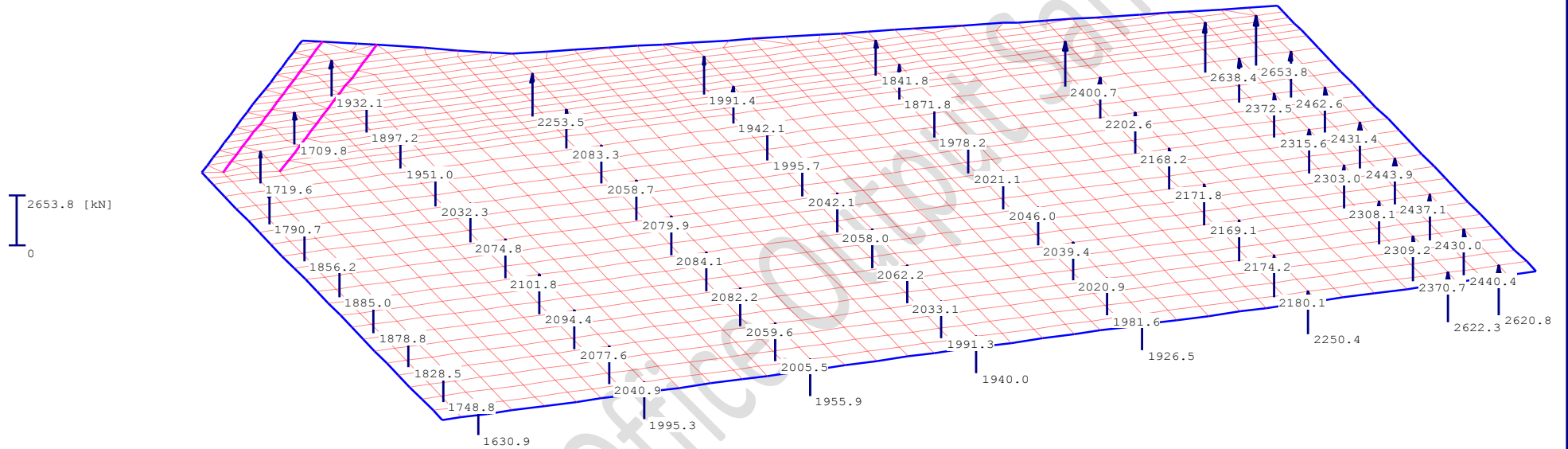

Support reactions V [kN]

Max. V = 2653.8 at node 1098, Min. V = 1630.9 at node 173, Sum = 147568.1

GEOTEC Software

P. O. Box 465, Port-Said, Egypt* Tel. +2066-3609247

Scale factor: 250

File: Pile foundation design_right side

Page No.:

Title: Pile foundation design-right side

Date: 25/09/2010

Project: Tarut bridge, Qatif city- Saudi Arabia

Tarut Bridge - Analysis and design of foundation

Method (2)
Modulus of subgrade reaction is defined by the user

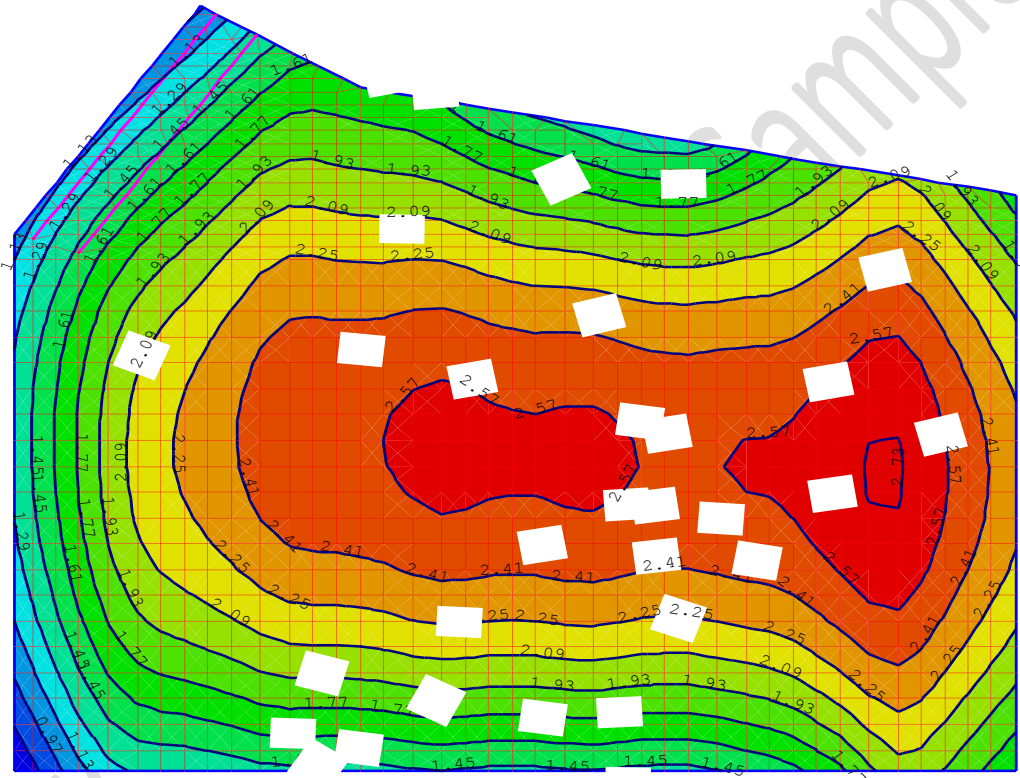
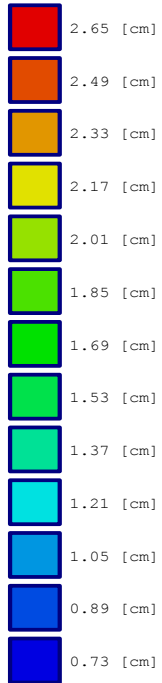

Settlements [cm]
Max. $s = 2.74$ at node 635, Min. $s = 0.65$ at node 1

GEOTEC Software

P. O. Box 465, Port-Said, Egypt* Tel. +2066-3609247

Scale 1:365

File: Pile foundation design_right side

Page No.:

Title: Pile foundation design-right side

Date: 25/09/2010

Project: Tarut bridge, Qatif city- Saudi Arabia

Tarut Bridge - Analysis and design of foundation

Method (2)
Modulus of subgrade reaction is defined by the user

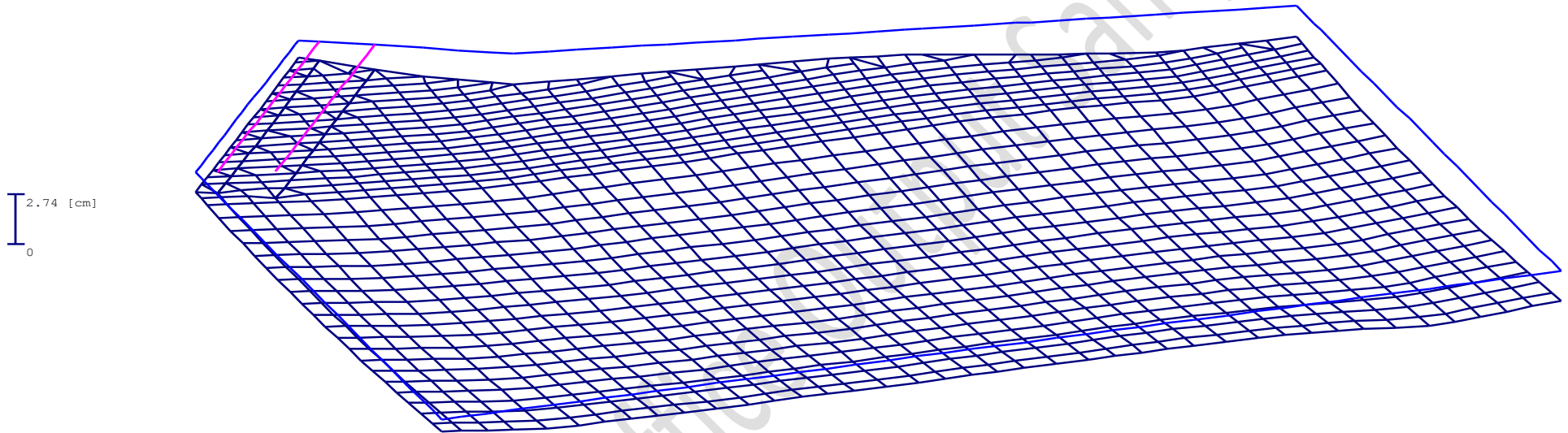

Slab deformation w [cm]
Max. $w = 2.74$ at node 635, Min. $w = 0.65$ at node 1

GEOTEC Software

P. O. Box 465, Port-Said, Egypt* Tel. +2066-3609247

Scale factor: 250

File: Pile foundation design_right side

Page No.:

Title: Pile foundation design-right side

Date: 25/09/2010

Project: Tarut bridge, Qatif city- Saudi Arabia

Tarut Bridge - Analysis and design of foundation

Method (2)

Modulus of subgrade reaction is defined by the user

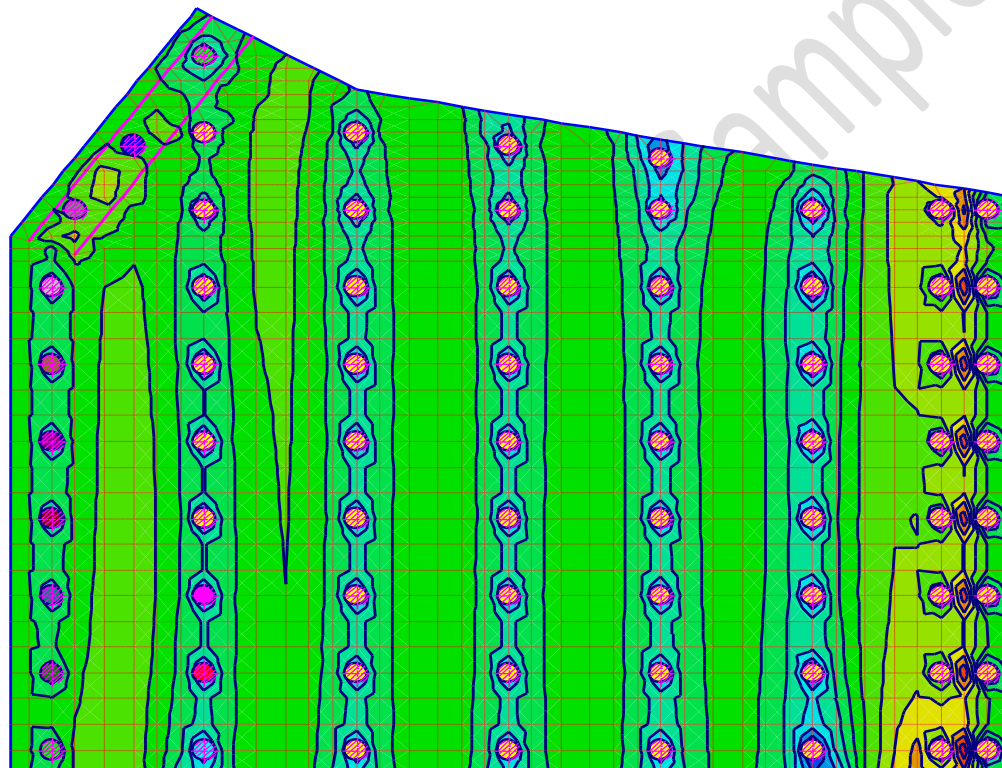
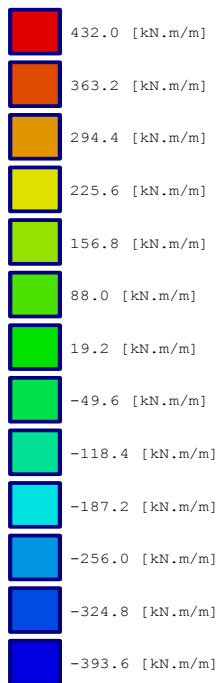

Moments m_x [kN.m/m]

Max. m_x = 466.8 at node 209, Min. m_x = -428.0 at node 203

GEOTEC Software

P. O. Box 465, Port-Said, Egypt* Tel. +2066-3609247

Scale 1:365

File: Pile foundation design_right side

Page No.:

Title: Pile foundation design-right side

Date: 25/09/2010

Project: Tarut bridge, Qatif city- Saudi Arabia

Tarut Bridge - Analysis and design of foundation

Method (2)
Modulus of subgrade reaction is defined by the user

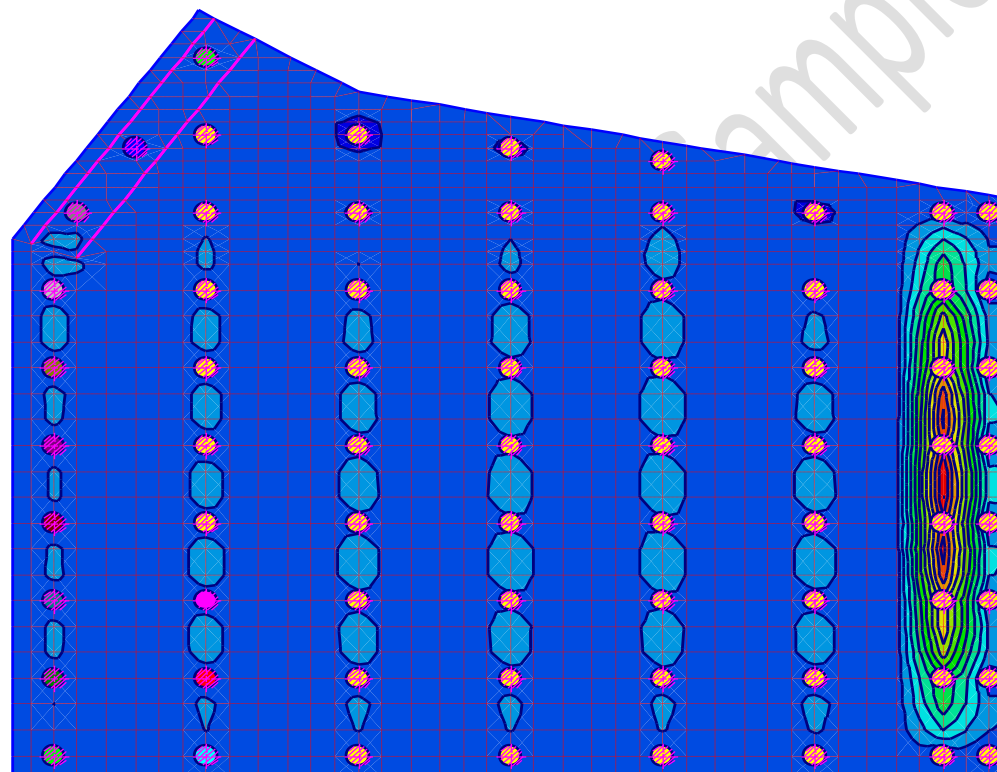
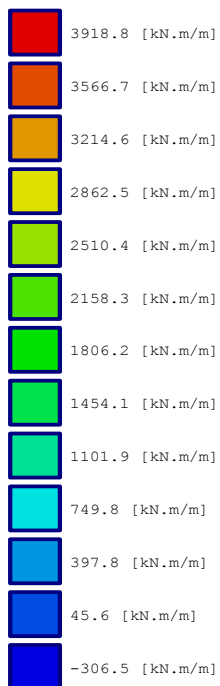

Moments m_y [kN.m/m]
Max. $m_y = 4094.9$ at node 598, Min. $m_y = -482.5$ at node 1242

GEOTEC Software

P. O. Box 465, Port-Said, Egypt* Tel. +2066-3609247

Scale 1:365

File: Pile foundation design_right side

Page No.:

Title: Pile foundation design-right side

Date: 25/09/2010

Project: Tarut bridge, Qatif city- Saudi Arabia

Tarut Bridge - Analysis and design of foundation

Method (2)

Modulus of subgrade reaction is defined by the user

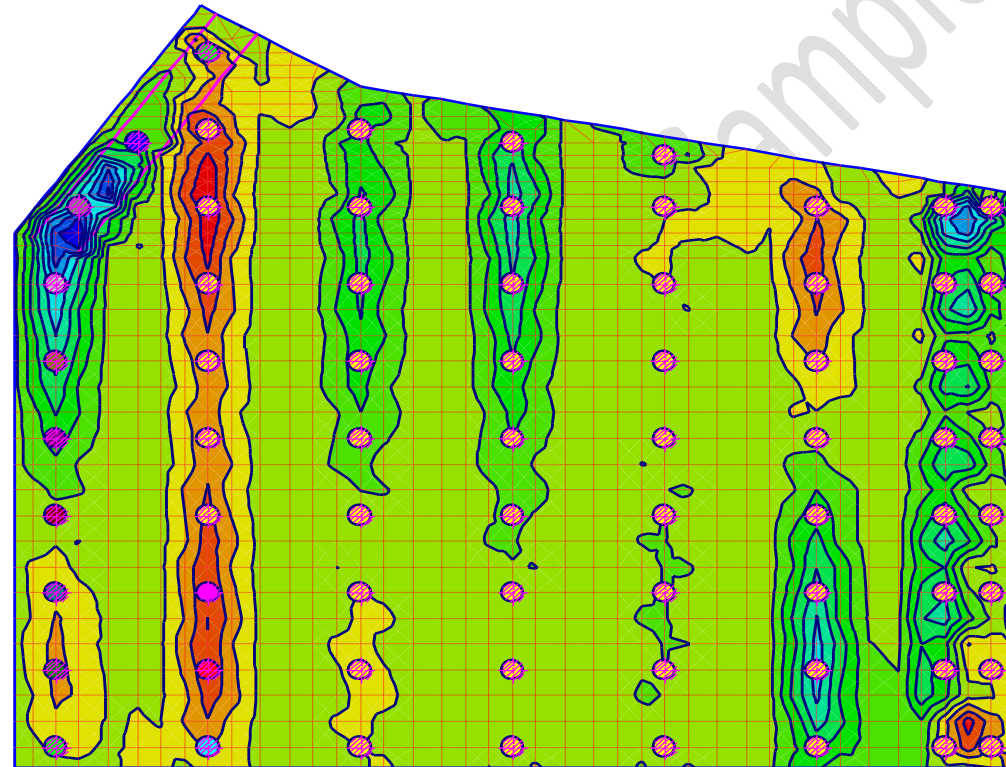
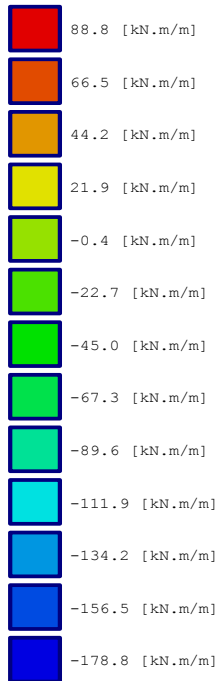

Moments m_{xy} [kN.m/m]

Max. m_{xy} = 99.5 at node 1236, Min. m_{xy} = -189.9 at node 991

GEOTEC Software

P. O. Box 465, Port-Said, Egypt* Tel. +2066-3609247

Scale 1:365

File: Pile foundation design_right side

Page No.:

Title: Pile foundation design-right side

Date: 25/09/2010

Project: Tarut bridge, Qatif city- Saudi Arabia

Tarut Bridge - Analysis and design of foundation

Method (2)
Modulus of subgrade reaction is defined by the user

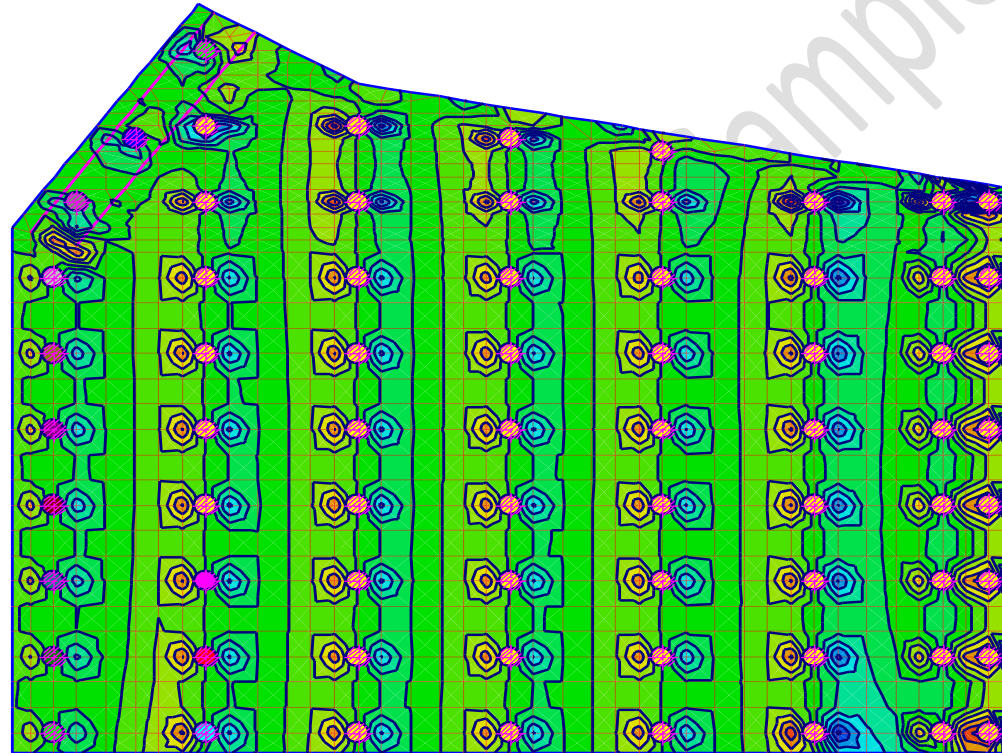
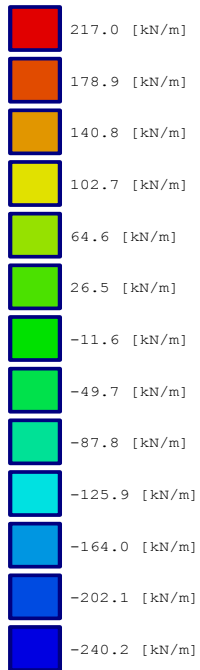

Shear forces Q_x [kN/m]
Max. $Q_x = 235.4$ at node 210, Min. $Q_x = -259.3$ at node 1092

GEOTEC Software

P. O. Box 465, Port-Said, Egypt* Tel. +2066-3609247

Scale 1:365

File: Pile foundation design_right side

Page No.:

Title: Pile foundation design-right side

Date: 25/09/2010

Project: Tarut bridge, Qatif city- Saudi Arabia

Tarut Bridge - Analysis and design of foundation

Method (2)
Modulus of subgrade reaction is defined by the user

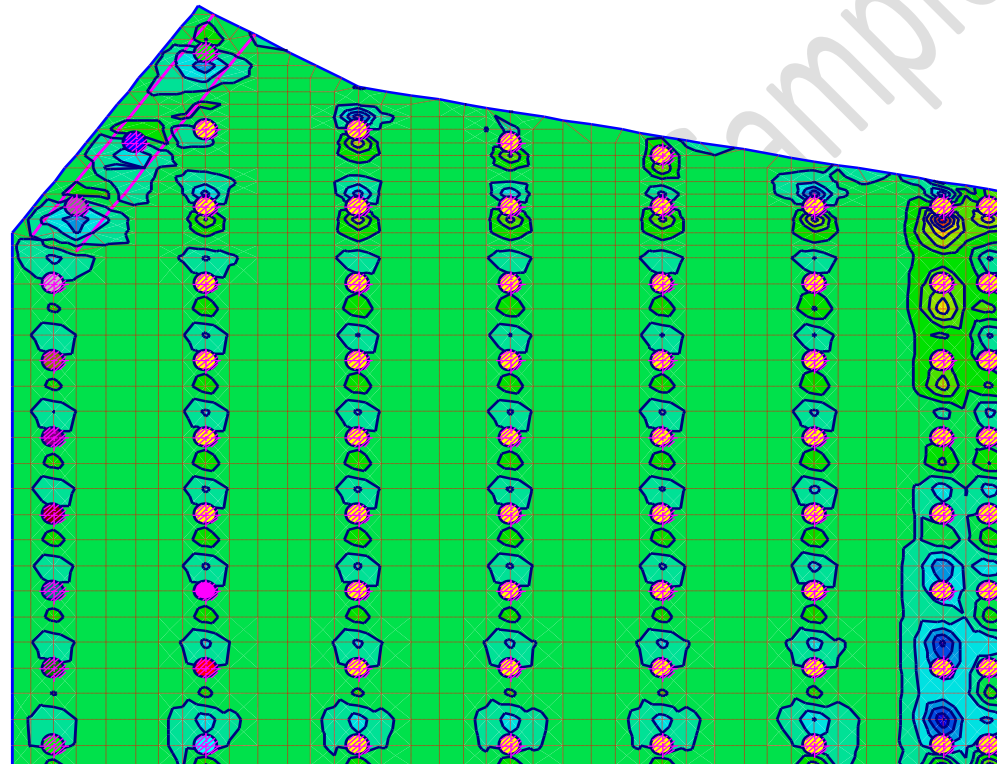
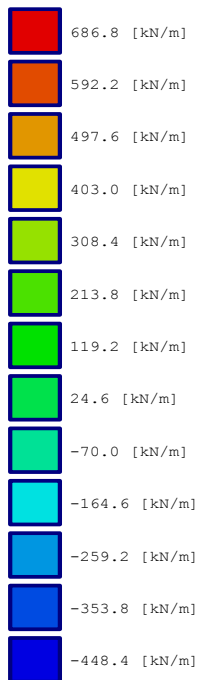

Shear forces Q_y [kN/m]
Max. $Q_y = 734.3$ at node 1060, Min. $Q_y = -495.7$ at node 247

GEOTECH Software

P. O. Box 465, Port-Said, Egypt* Tel. +2066-3609247

Scale 1:365

File: Pile foundation design_right side

Page No.:

Title: Pile foundation design-right side

Date: 25/09/2010

Project: Tarut bridge, Qatif city- Saudi Arabia

Tarut Bridge - Analysis and design of foundation

Method (2)

Modulus of subgrade reaction is defined by the user

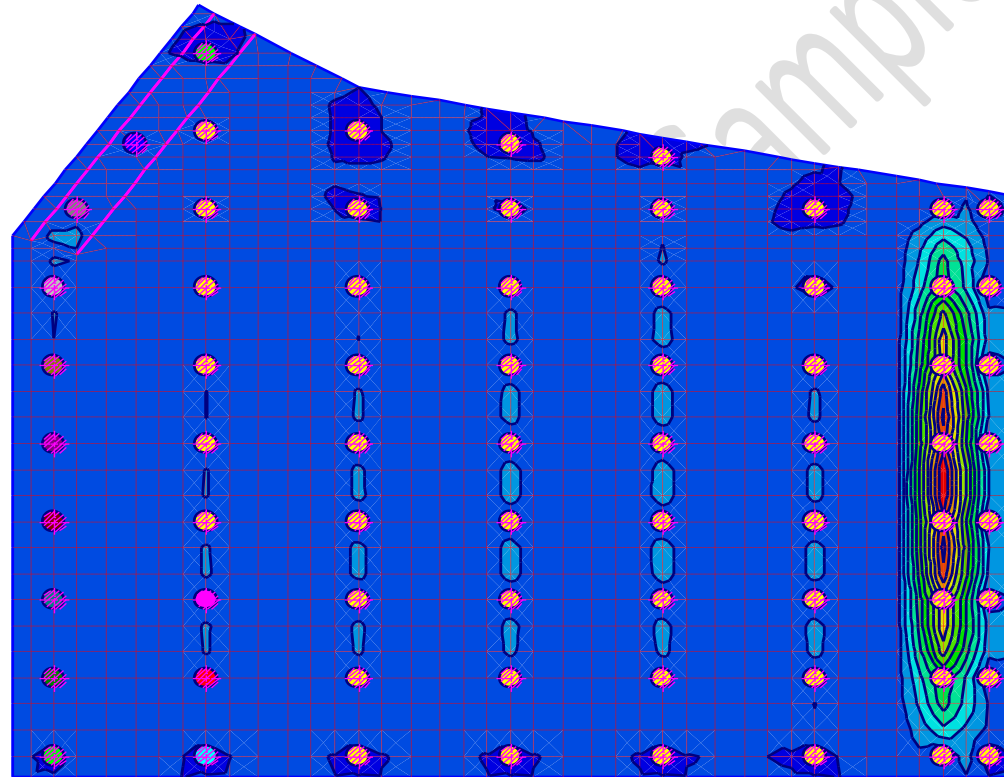
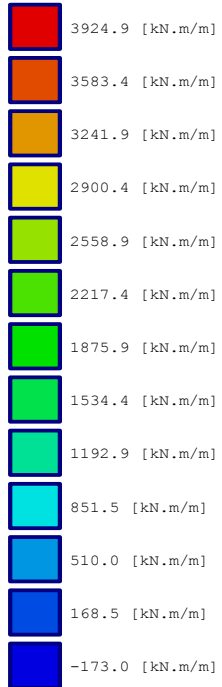

Principal moments h_{m1} [kN.m/m]

Max. h_{m1} = 4095.4 at node 598, Min. h_{m1} = -343.8 at node 1091

GEOTEC Software

P. O. Box 465, Port-Said, Egypt* Tel. +2066-3609247

Scale 1:365

File: Pile foundation design_right side

Page No.:

Title: Pile foundation design-right side

Date: 25/09/2010

Project: Tarut bridge, Qatif city- Saudi Arabia

Tarut Bridge - Analysis and design of foundation

Method (2)

Modulus of subgrade reaction is defined by the user

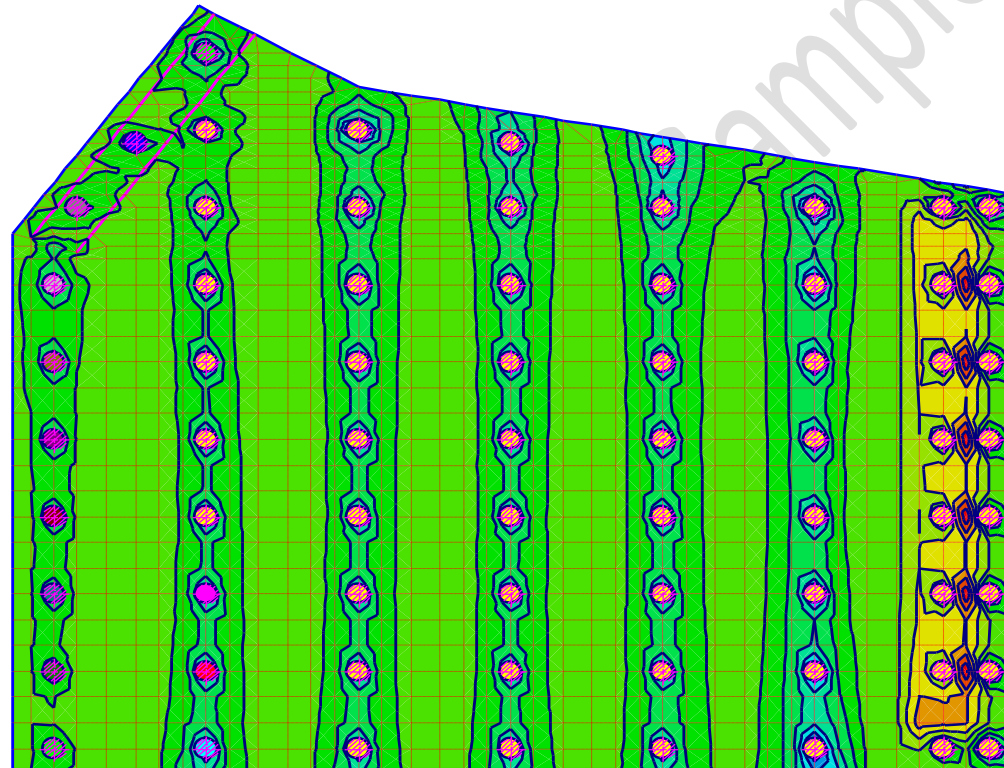
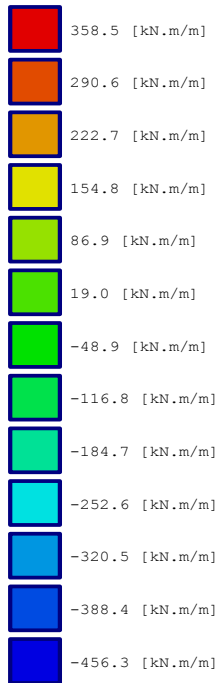

Principal moments hm_2 [$kN.m/m$]

Max. hm_2 = 393.0 at node 326, Min. hm_2 = -490.3 at node 1242

GEOTECH Software

P. O. Box 465, Port-Said, Egypt* Tel. +2066-3609247

Scale 1:365

File: Pile foundation design_right side

Page No.:

Title: Pile foundation design-right side

Date: 25/09/2010

Project: Tarut bridge, Qatif city- Saudi Arabia

Tarut Bridge - Analysis and design of foundation

Method (2)

Modulus of subgrade reaction is defined by the user

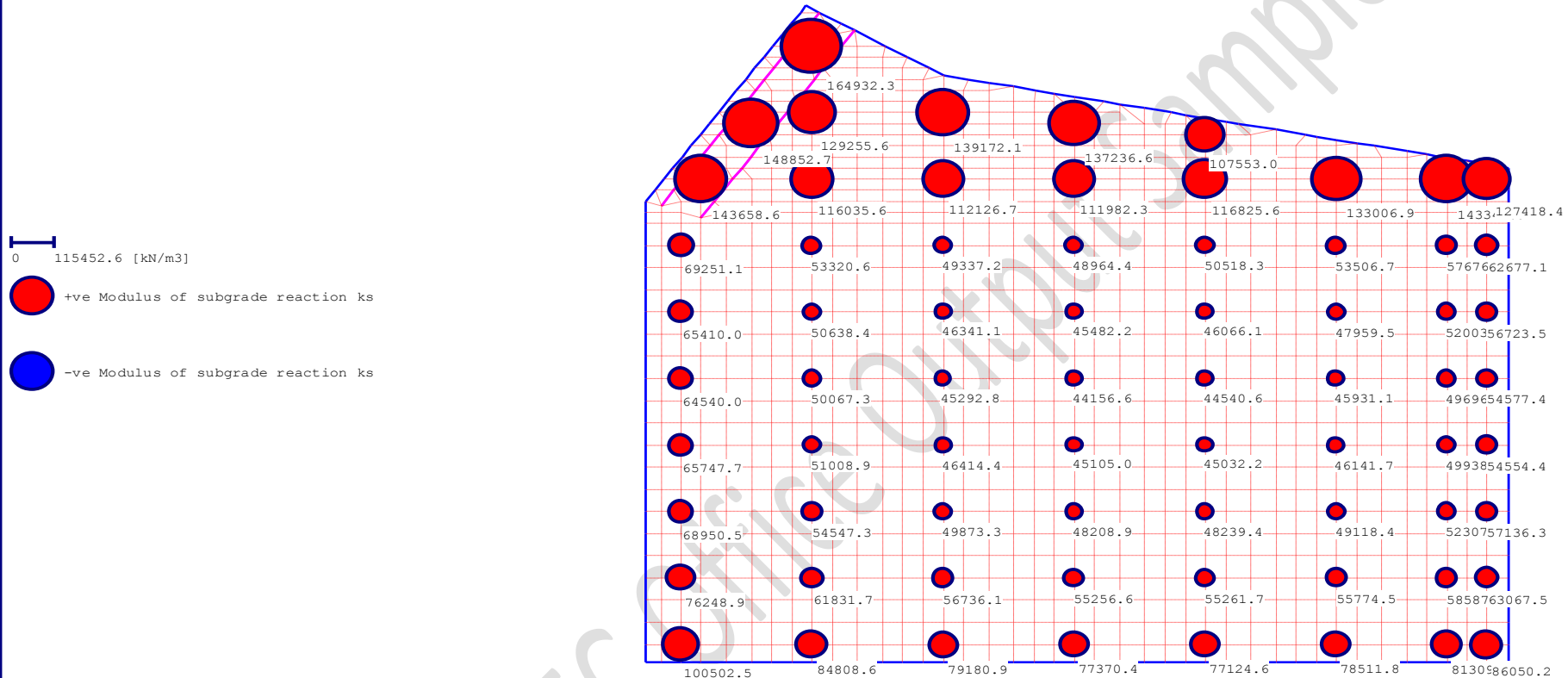

Modulus of subgrade reaction ks [kN/m3]

Max. ks = 164932.3 at node 1288, Min. ks = 0.0 at node 1

GEOTEC Software

P. O. Box 465, Port-Said, Egypt* Tel. +2066-3609247

Scale 1:365

File: Pile foundation design_right side

Page No.:

Title: Pile foundation design-right side

Date: 25/09/2010

Project: Tarut bridge, Qatif city- Saudi Arabia

Tarut Bridge - Analysis and design of foundation

Method (2)
Modulus of subgrade reaction is defined by the user

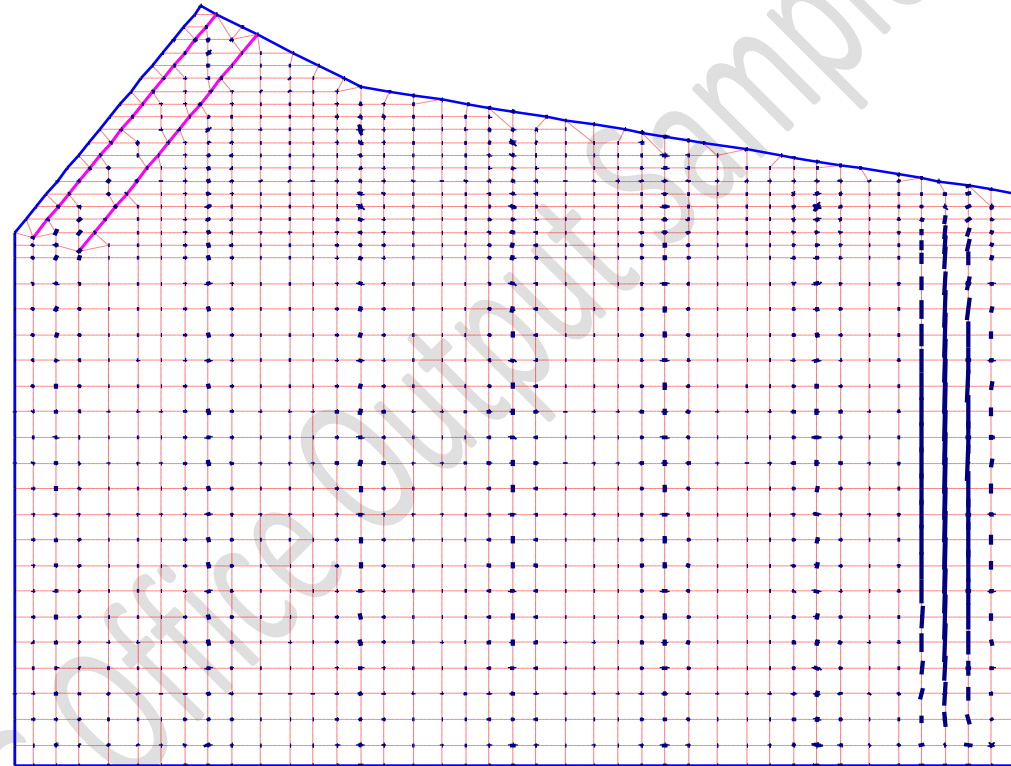
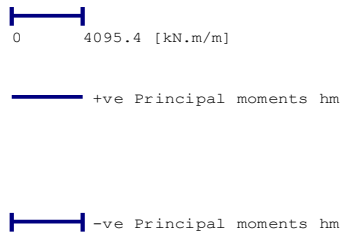

Principal moments hm [kN.m/m]
Max. hm = 4095.4 at node 598, Min. hm = -490.3 at node 1242

GEO-TEC Software
P. O. Box 465, Port-Said, Egypt* Tel. +2066-3609247

Scale 1:365

File: Pile foundation design_right side

Page No.:

Title: Pile foundation design-right side

Date: 25/09/2010

Project: Tarut bridge, Qatif city- Saudi Arabia

Tarut Bridge - Analysis and design of foundation

Method (2)
Modulus of subgrade reaction is defined by the user

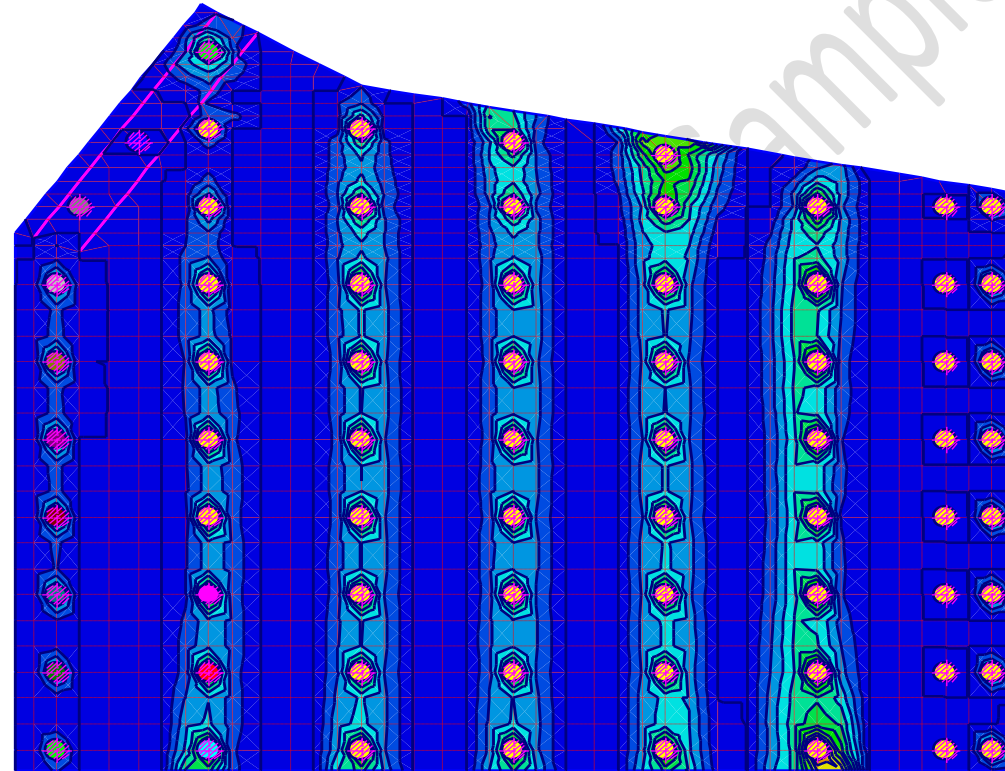
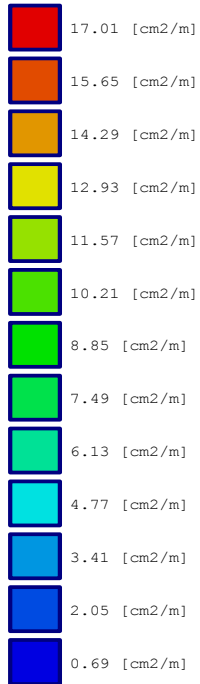

Top reinforcement in x-direction A_{s_topx} [cm2/m]
Max. A_{s_topx} = 17.69 at node 203, Min. A_{s_topx} = 0.01 at node 603

GEOTEC Software

P. O. Box 465, Port-Said, Egypt* Tel. +2066-3609247

Scale 1:365

File: Pile foundation design_right side

Page No.:

Title: Pile foundation design-right side

Date: 25/09/2010

Project: Tarut bridge, Qatif city- Saudi Arabia

Tarut Bridge - Analysis and design of foundation

Method (2)

Modulus of subgrade reaction is defined by the user

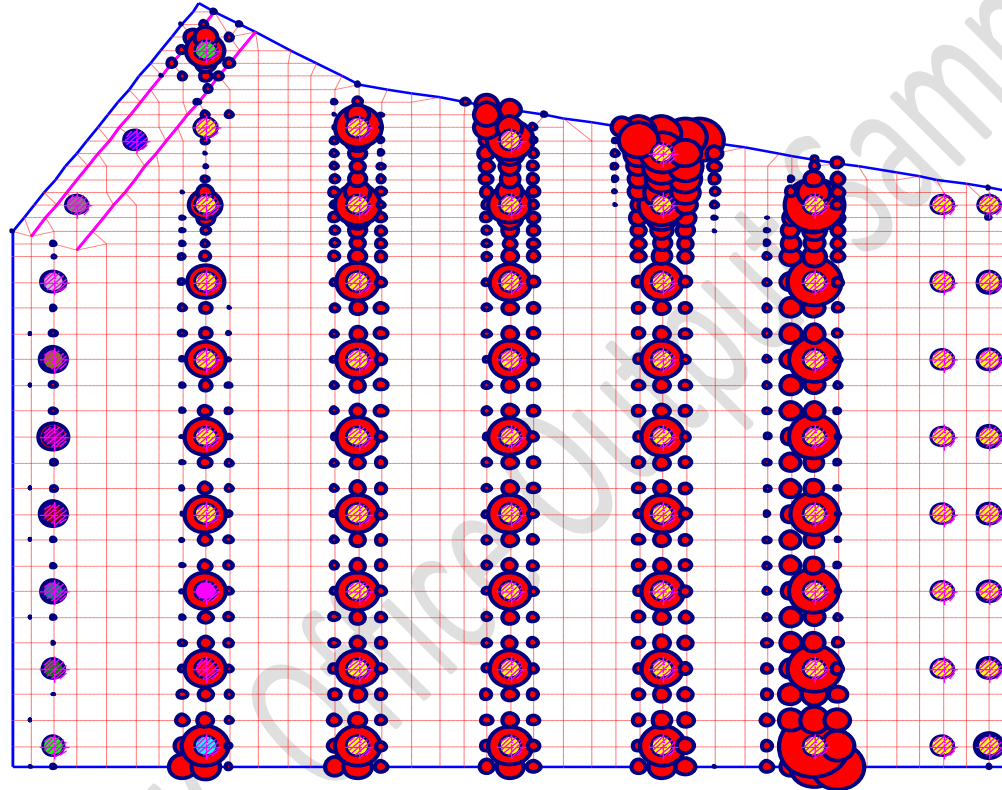

Top reinforcement in x-direction A_{s_topx} [cm²/m]

Max. A_{s_topx} = 17.69 at node 203, Min. A_{s_topx} = 0.01 at node 603

GEOTEC Software

P. O. Box 465, Port-Said, Egypt* Tel. +2066-3609247

Scale 1:365

File: Pile foundation design_right side

Page No.:

Title: Pile foundation design-right side

Date: 25/09/2010

Project: Tarut bridge, Qatif city- Saudi Arabia

Tarut Bridge - Analysis and design of foundation

Method (2)
Modulus of subgrade reaction is defined by the user

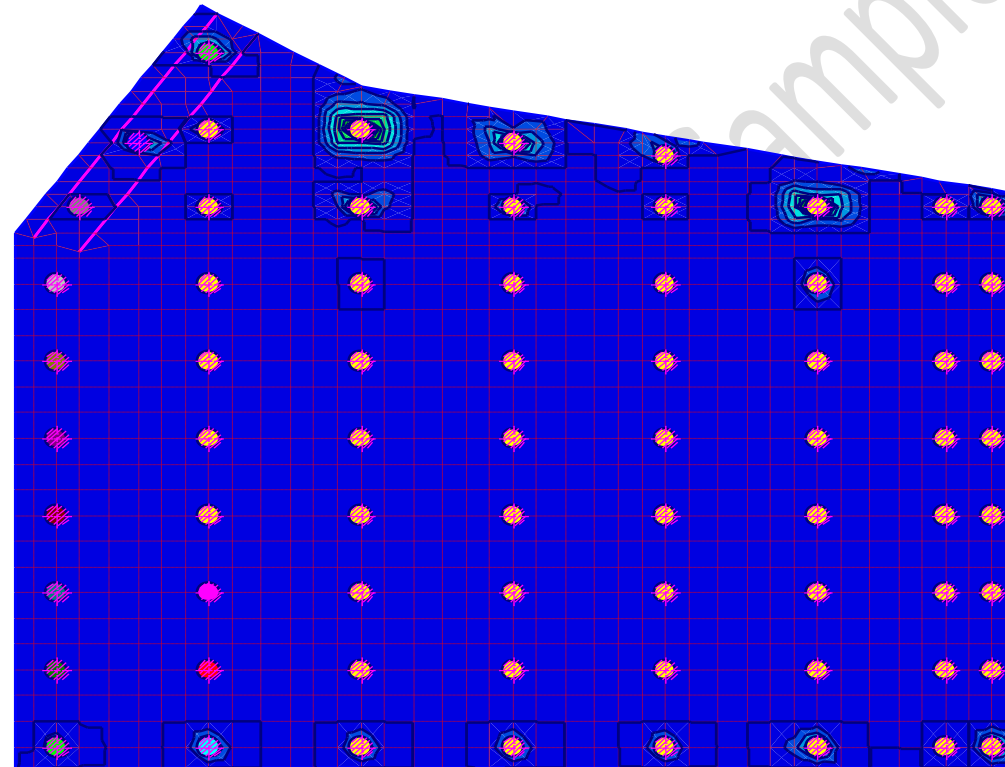
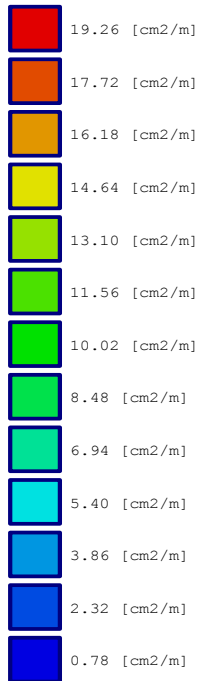

Top reinforcement in y-direction A_{s_topy} [cm2/m]
Max. A_{s_topy} = 20.02 at node 1242, Min. A_{s_topy} = 0.01 at node 97

GEOTEC Software

P. O. Box 465, Port-Said, Egypt* Tel. +2066-3609247

Scale 1:365

File: Pile foundation design_right side

Page No.:

Title: Pile foundation design-right side

Date: 25/09/2010

Project: Tarut bridge, Qatif city- Saudi Arabia

Tarut Bridge - Analysis and design of foundation

Method (2)
Modulus of subgrade reaction is defined by the user

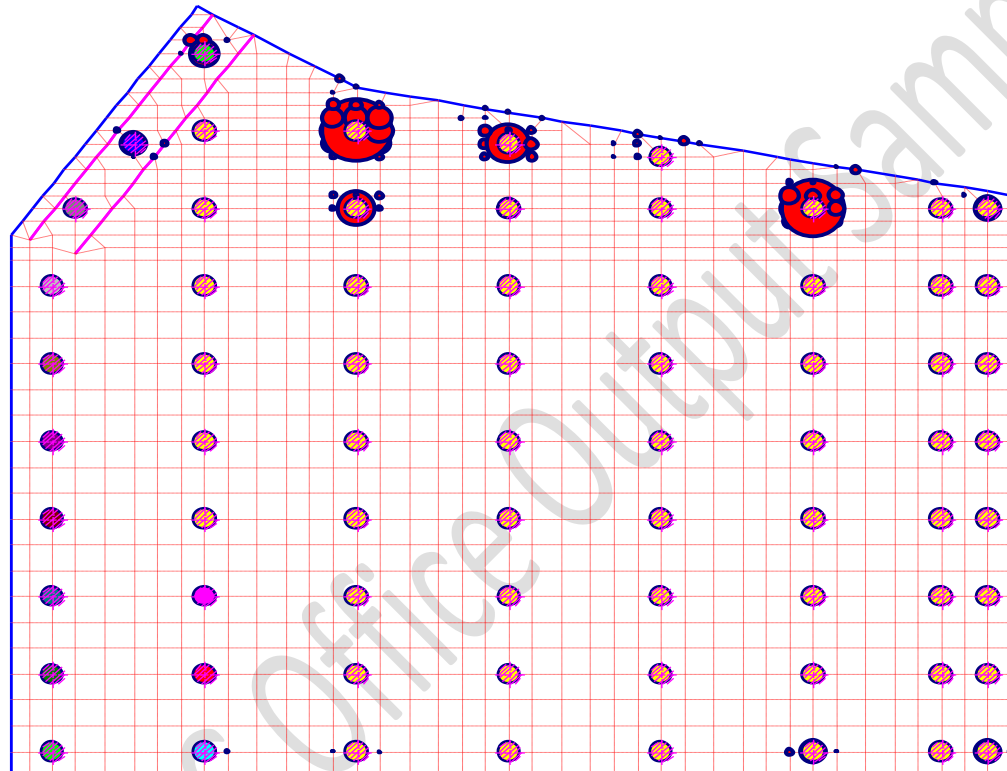

Top reinforcement in y-direction A_{s_topy} [cm²/m]
Max. A_{s_topy} = 20.02 at node 1242, Min. A_{s_topy} = 0.01 at node 97

GEOTEC Software

P. O. Box 465, Port-Said, Egypt* Tel. +2066-3609247

Scale 1:365

File: Pile foundation design_right side

Page No.:

Title: Pile foundation design-right side

Date: 25/09/2010

Project: Tarut bridge, Qatif city- Saudi Arabia

Tarut Bridge - Analysis and design of foundation

Method (2)

Modulus of subgrade reaction is defined by the user

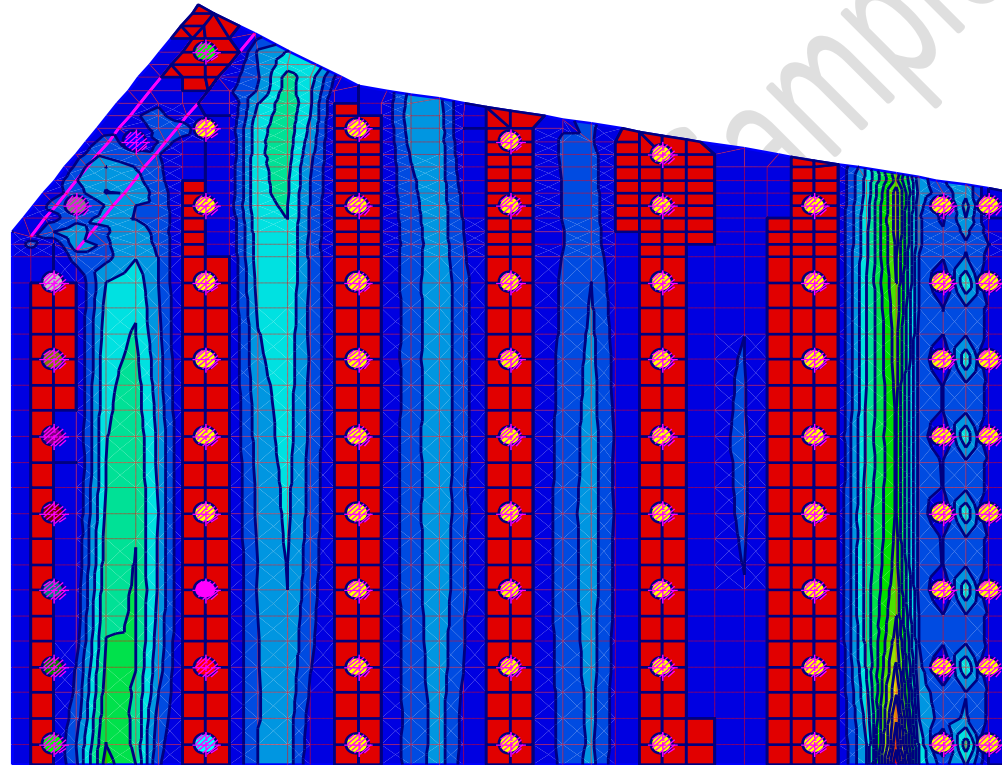
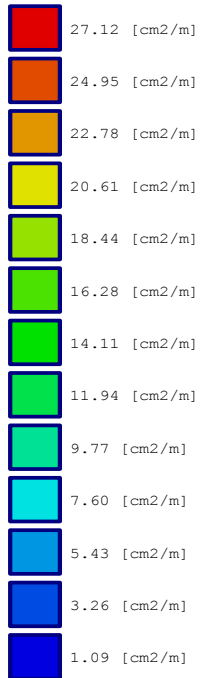

Bottom reinforcement in x-direction A_{s_botx} [cm2/m]

Max. A_{s_botx} = 28.16 at node 45, Min. A_{s_botx} = 0.00 at node 58

GEOTEC Software

P. O. Box 465, Port-Said, Egypt* Tel. +2066-3609247

Scale 1:365

File: Pile foundation design_right side

Page No.:

Title: Pile foundation design-right side

Date: 25/09/2010

Project: Tarut bridge, Qatif city- Saudi Arabia

Tarut Bridge - Analysis and design of foundation

Method (2)

Modulus of subgrade reaction is defined by the user

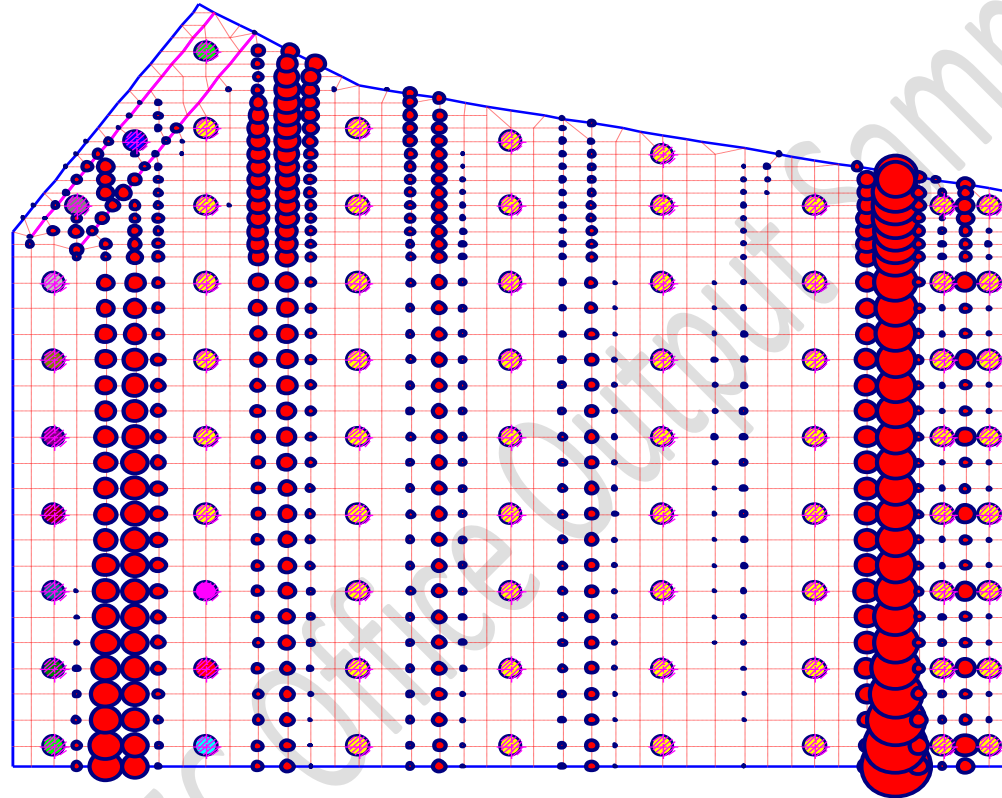

Bottom reinforcement in x-direction A_{s_botx} [cm²/m]

Max. A_{s_botx} = 28.16 at node 45, Min. A_{s_botx} = 0.00 at node 58

GEOTEC Software

P. O. Box 465, Port-Said, Egypt* Tel. +2066-3609247

Scale 1:365

File: Pile foundation design_right side

Page No.:

Title: Pile foundation design-right side

Date: 25/09/2010

Project: Tarut bridge, Qatif city- Saudi Arabia

Tarut Bridge - Analysis and design of foundation

Method (2)
Modulus of subgrade reaction is defined by the user

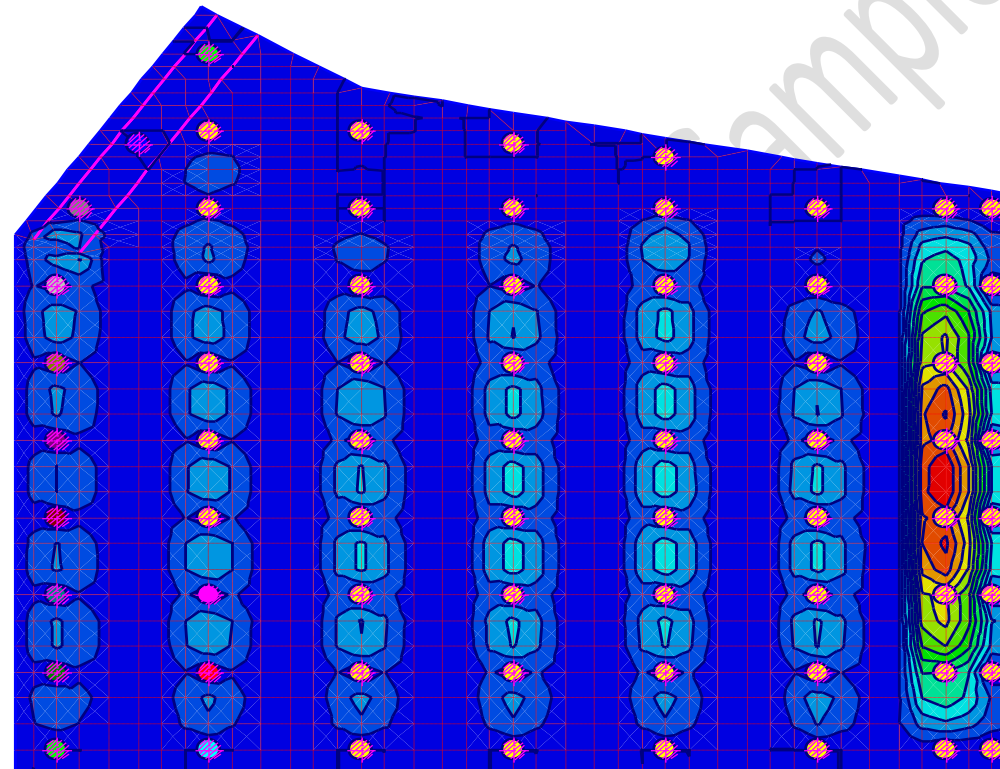
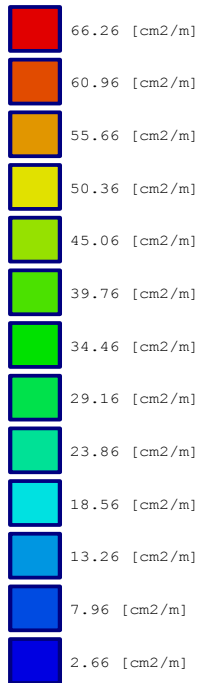

Bottom reinforcement in y-direction A_{s_boty} [cm2/m]
Max. A_{s_boty} = 68.85 at node 598, Min. A_{s_boty} = 0.01 at node 1173

GEOTECH Software

P. O. Box 465, Port-Said, Egypt* Tel. +2066-3609247

Scale 1:365

File: Pile foundation design_right side

Page No.:

Title: Pile foundation design-right side

Date: 25/09/2010

Project: Tarut bridge, Qatif city- Saudi Arabia

Tarut Bridge - Analysis and design of foundation

Method (2)
Modulus of subgrade reaction is defined by the user

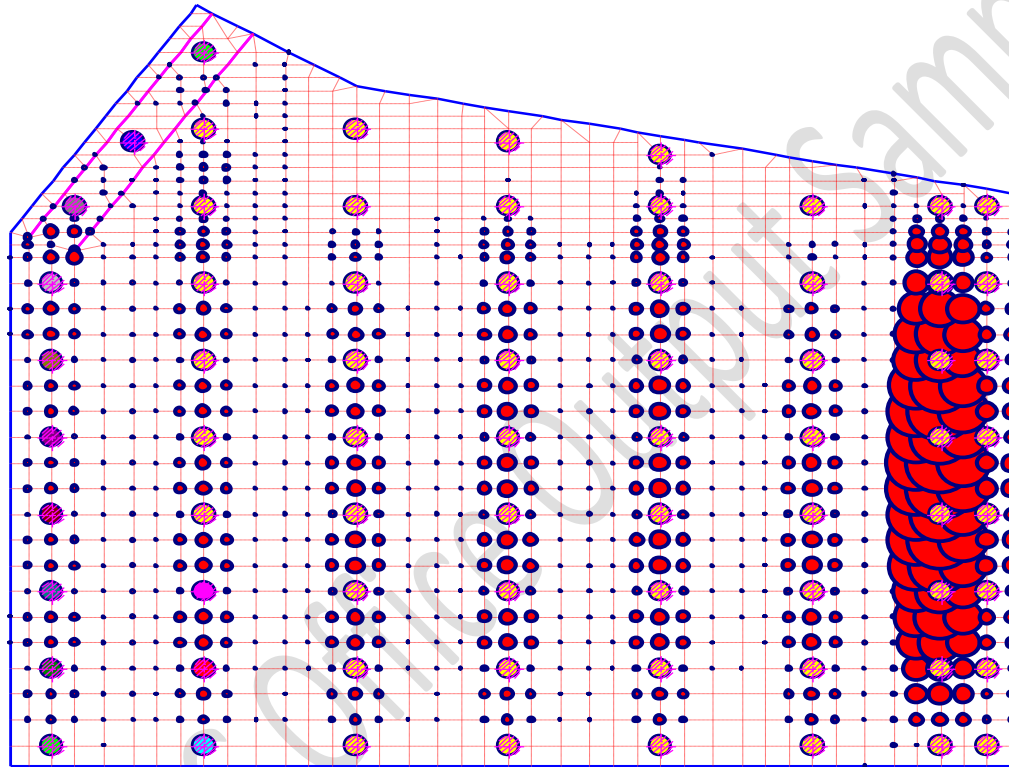

Bottom reinforcement in y-direction A_{s_boty} [cm²/m]
Max. A_{s_boty} = 68.85 at node 598, Min. A_{s_boty} = 0.01 at node 1173

GEOTEC Software

P. O. Box 465, Port-Said, Egypt* Tel. +2066-3609247

Scale 1:365

File: Pile foundation design_right side

Page No.:

Title: Pile foundation design-right side

Date: 25/09/2010

Project: Tarut bridge, Qatif city- Saudi Arabia

12 Tunnel floor analysis – Left side

```
*****  
Analysis of slab foundation  
by the program package ELPLA  
Version 9.2 SP1  
*****
```

Title: Pile foundation analysis of the tunnel-left side
Date: 25/09/2010
Project: Tarut bridge, Qatif city- Saudi Arabia
File: Tunnel floor analysis

Calculation method:
Method (9) (Layered soil model)
Rigid free-standing raft

Program authors Prof. M. El Gendy/ Dr. A. El Gendy
GEOTEC Software Inc. PO Box 14001 Richmond Road PO, Calgary AB, Canada T3E 7Y7
www.geotecsoftware.com; geotec@geotecsoftware.com ; Tele.:+1(587) 332-3323

Tarut Bridge - Analysis and design of foundation

GEOTEC

PO Box 14001 Richmond Road PO, Calgary AB, Canada T3E 7Y7

Soil data

Title: Pile foundation analysis of the tunnel-left side

Date: 25/09/2010

Project: Tarut bridge, Qatif city- Saudi Arabia

File: Tunnel floor analysis

Analysis of slab foundation
by the program package ELPLA
Version 9.2 SP1

Calculation method:

Method (9) (Layered soil model)

Rigid free-standing raft

Soil data

Groundwater depth under the ground surface

GW [m] = 0

Settlement reduction factor

Alfa [-] = 1

Boring layers

Boring log No.: 1

Boring Log Label: B1

Location of boring in global coordinates system

Xb [m] = 0.00

Yb [m] = 0.00

Layer No.: 1

Symbole for soil type and rocks after DIN 4023: S

Level of layer under ground

z [m] = 2.50

Modulus of Elasticity of the soil (Loading)

E [kN/m²] = 18500

Modulus of Elasticity of the soil (Reloading)

W [kN/m²] = 18500

Poisson's ratio of soil

Nue [-] = 0

Unit weight of the soil

Gama [kN/m³] = 6.2

Angle of internal friction

Fhi [°] = 30.00

Cohesion of the soil

c [kN/m²] = 0

Layer No.: 2

Symbole for soil type and rocks after DIN 4023: T

Level of layer under ground

z [m] = 5.00

Modulus of Elasticity of the soil (Loading)

E [kN/m²] = 10000

Modulus of Elasticity of the soil (Reloading)

W [kN/m²] = 10000

Poisson's ratio of soil

Nue [-] = 0

Unit weight of the soil

Gama [kN/m³] = 5.2

Angle of internal friction

Fhi [°] = 0.00

Cohesion of the soil

c [kN/m²] = 75

Layer No.: 3

Symbole for soil type and rocks after DIN 4023: S

Level of layer under ground

z [m] = 20.00

Modulus of Elasticity of the soil (Loading)

E [kN/m²] = 43000

Modulus of Elasticity of the soil (Reloading)

W [kN/m²] = 43000

Poisson's ratio of soil

Nue [-] = 0

Unit weight of the soil

Gama [kN/m³] = 9.2

Angle of internal friction

Fhi [°] = 36.00

Cohesion of the soil

c [kN/m²] = 0

Layer No.: 4

Symbole for soil type and rocks after DIN 4023: T

Level of layer under ground

z [m] = 50.00

Modulus of Elasticity of the soil (Loading)

E [kN/m²] = 47000

Modulus of Elasticity of the soil (Reloading)

W [kN/m²] = 47000

Poisson's ratio of soil

Nue [-] = 0

Unit weight of the soil

Gama [kN/m³] = 9.7

Angle of internal friction

Fhi [°] = 0.00

Cohesion of the soil

c [kN/m²] = 200

GEOTEC

Tarut Bridge - Analysis and design of foundation

PO Box 14001 Richmond Road PO, Calgary AB, Canada T3E 7Y7

Slab properties/ Foundation level/ Global coordinates

Title: Pile foundation analysis of the tunnel-left side

Date: 25/09/2010

Project: Tarut bridge, Qatif city- Saudi Arabia

File: Tunnel floor analysis

Analysis of slab foundation
by the program package ELPLA
Version 9.2 SP1

Calculation method:

Method (9) (Layered soil model)

Rigid free-standing raft

Slab properties/ Foundation level/ Global coordinates

Unit weight of slab material GB [kN/m3] = 25.0

Element groups (with the same thickness and material):

Group No.	E-Modulus of slab Ep [kN/m2]	Poisson's ratio Nue [-]	Slab thickness d [m]
1	2.4E+07	0.2	1.6

GEOTEC

PO Box 14001 Richmond Road PO, Calgary AB, Canada T3E 7Y7

Tarut Bridge - Analysis and design of foundation

Loads

Title: Pile foundation analysis of the tunnel-left side
 Date: 25/09/2010
 Project: Tarut bridge, Qatif city- Saudi Arabia
 File: Tunnel floor analysis

Analysis of slab foundation
 by the program package ELPLA
 Version 9.2 SP1

Calculation method:
 Method (9) (Layered soil model)
 Rigid free-standing raft

Line loads:

Load No.	Load start value	Load end value	Load start	Load start	Load end	Load end
I	P1	P1	x1	y1	x2	y2
[-]	[kN/m]	[kN/m]	[m]	[m]	[m]	[m]
1	216	216	1.5	42	1.5	1.5
2	218	218	9.5	1.5	9.5	42
3	85	85	1.5	42	9.5	42
4	85	85	1.5	1.5	9.5	1.5

Distributed loads (Rectangle):

Load No.	Load value	Load start	Load start	Load end	Load end
I	P	x1	y1	x2	y2
[-]	[kN/m2]	[m]	[m]	[m]	[m]
1	6	1.5	42	9.5	1.5

Tarut Bridge - Analysis and design of foundation

Loads

Loading data:

Distribute column loads: (Yes)			
Slab weight	Pe	[kN]	= 19140.0
Force on slab	Pa	[kN]	= 49951.5
Groundwater force	Pw	[kN]	= 0.0
Total load ($P = Pe + Pa - Pw$)	P	[kN]	= 69091.5
Groundwater pressure on raft	Qw	[kN/m ²]	= 0.0
Average contact pressure	Qo	[kN/m ²]	= 144.4
Sum Mx from loads	Mx	[kN.m]	= 0.0
Sum My from loads	My	[kN.m]	= 324.0
Eccentricity of loading in x-direction	ex	[cm]	= 0.47
Eccentricity of loading in y-direction	ey	[cm]	= 0.00
Moment of inertia of slab about x-Axis	Ix	[m ⁴]	= 75453.28
Moment of inertia of slab about y-Axis	Iy	[m ⁴]	= 4824.86
Product of inertia	Ixy	[m ⁴]	= 0.00
Area of the slab	A	[m ²]	= 478.50
Volume of the slab	V	[m ³]	= 765.60

GEOTEC

PO Box 14001 Richmond Road PO, Calgary AB, Canada T3E 7Y7

Data of piles

Tarut Bridge - Analysis and design of foundation

Title: Pile foundation analysis of the tunnel-left side
Date: 25/09/2010
Project: Tarut bridge, Qatif city- Saudi Arabia
File: Tunnel floor analysis

Analysis of slab foundation
by the program package ELPLA
Version 9.2 SP1

Calculation method:
Method (9) (Layered soil model)
Rigid free-standing raft

Pile groups:

Group No.: 1
Description of pile groups: P1
Pile diameter
Pile toe diameter
Pile length

D [m] = 1.2
Df [m] = 1.2
Lg [m] = 28

Soil data under the pile tip:

Pile tip resistance (s/Df = 0.02) Sig [kN/m2] = 500
Pile tip resistance (s/Df = 0.03) Sig1 [kN/m2] = 700
Pile tip resistance (s/Df = 0.1) SigGR [kN/m2] = 1200

Geotechnical data of the layer:

Layer No.	Layer thickness	Undrainage cohesion	Penetration resistance	Skin friction
I	L1	Cu	qs	Tau
[-]	[m]	[kN/m2]	[kN/m2]	[kN/m2]
1	2.50	-	-	0
2	2.50	-	-	35
3	15.00	-	-	100
4	8.00	-	-	50

Pile locations and groups:

Pile No.	Node No.	X-coord.	Y-coord.	Group No.
[-]	[-]	[m]	[m]	[-]
1	105	1.50	1.50	1
2	113	9.50	1.50	1
3	109	5.50	1.50	1
4	132	1.50	4.50	1
5	136	5.50	4.50	1
6	140	9.50	4.50	1
7	159	1.50	7.50	1
8	163	5.50	7.50	1
9	167	9.50	7.50	1
10	195	1.50	11.50	1
11	199	5.50	11.50	1
12	203	9.50	11.50	1
13	231	1.50	15.50	1
14	235	5.50	15.50	1
15	239	9.50	15.50	1
16	267	1.50	19.50	1

Continue of table at next page

GEOTEC
PO Box 14001 Richmond Road PO, Calgary AB, Canada T3E 7Y7

Data of piles

Tarut Bridge - Analysis and design of foundation

Continue of table

File No. [-]	Node No. [-]	X-coord. [m]	Y-coord. [m]	Group No. [-]
17	271	5.50	19.50	1
18	275	9.50	19.50	1
19	303	1.50	24.00	1
20	307	5.50	24.00	1
21	311	9.50	24.00	1
22	339	1.50	28.00	1
23	343	5.50	28.00	1
24	347	9.50	28.00	1
25	375	1.50	32.00	1
26	379	5.50	32.00	1
27	383	9.50	32.00	1
28	411	1.50	36.00	1
29	415	5.50	36.00	1
30	419	9.50	36.00	1
31	438	1.50	39.00	1
32	465	1.50	42.00	1
33	442	5.50	39.00	1
34	469	5.50	42.00	1
35	473	9.50	42.00	1
36	446	9.50	39.00	1

File material:

Modulus of elasticity of pile E_p [kN/m²] = 24000000.00
 Unit weight of pile concrete GP [kN/m³] = 25.50
 (including 0.5 pile length above see bed)

GEOTEC

PO Box 14001 Richmond Road PO, Calgary AB, Canada T3E 7Y7

Support reactions

Title: Pile foundation analysis of the tunnel-left side

Tarut Bridge - Analysis and design of foundation

Date: 25/09/2010

Project: Tarut bridge, Qatif city- Saudi Arabia

File: Tunnel floor analysis

Analysis of slab foundation
by the program package ELPLA
Version 9.2 SP1

Calculation method:

Method (9) (Layered soil model)

Rigid free-standing raft

Support reactions

Node No.	Load-V	Moment-Y	Moment-X
I	V	My	Mx
[-]	[kN]	[kN.m]	[kN.m]
105	2397.5	0.0	0.0
109	2212.6	0.0	0.0
113	2405.2	0.0	0.0
132	2065.7	0.0	0.0
136	1880.8	0.0	0.0
140	2072.6	0.0	0.0
159	1927.1	0.0	0.0
163	1750.6	0.0	0.0
167	1933.7	0.0	0.0
195	1849.4	0.0	0.0
199	1684.4	0.0	0.0
203	1855.9	0.0	0.0
231	1806.4	0.0	0.0
235	1648.6	0.0	0.0
239	1812.8	0.0	0.0
267	1796.5	0.0	0.0
271	1642.6	0.0	0.0
275	1803.0	0.0	0.0
303	1796.5	0.0	0.0
307	1642.6	0.0	0.0
311	1803.0	0.0	0.0
339	1806.4	0.0	0.0
343	1648.6	0.0	0.0
347	1812.8	0.0	0.0
375	1849.4	0.0	0.0
379	1684.4	0.0	0.0
383	1855.9	0.0	0.0
411	1927.1	0.0	0.0
415	1750.6	0.0	0.0
419	1933.7	0.0	0.0
438	2065.7	0.0	0.0
442	1880.8	0.0	0.0
446	2072.6	0.0	0.0
465	2397.5	0.0	0.0
469	2212.6	0.0	0.0
473	2405.2	0.0	0.0

Sum. V 69091.5

GEOTEC

PO Box 14001 Richmond Road PO, Calgary AB, Canada T3E 7Y7

File results

Title: Pile foundation analysis of the tunnel-left side

Date: 25/09/2010

Tarut Bridge - Analysis and design of foundation

Project: Tarut bridge, Qatif city- Saudi Arabia
 File: Tunnel floor analysis

Analysis of slab foundation
 by the program package ELPLA
 Version 9.2 SP1

Calculation method:
 Method (9) (Layered soil model)
 Rigid free-standing raft

File results

Value of total load (including own wt.)	Po [kN] = 69091.5
Total pile loads	PL [kN] = 69091.5
Bearing factor of piled raft	Alfa-Kpp [%] = 100.00

File loads and displacements

Pile No.	pile load Fr [kN]	Settlement Sr [cm]	Soil stiffness ks [kN/m]
1	2397.5	1.78	134759.5
2	2405.2	1.78	135344.8
3	2212.6	1.78	124285.0
4	2065.7	1.78	116276.8
5	1880.8	1.78	105647.5
6	2072.6	1.78	116420.9
7	1927.1	1.78	108441.3
8	1750.6	1.78	98537.9
9	1933.7	1.78	108617.3
10	1849.4	1.78	103912.7
11	1684.4	1.78	94713.2
12	1855.9	1.78	104466.3
13	1806.4	1.78	101516.2
14	1648.6	1.78	92719.2
15	1812.8	1.78	101857.3
16	1796.5	1.78	100979.8
17	1642.6	1.78	92394.8
18	1803.0	1.78	101320.9
19	1796.5	1.78	100999.1
20	1642.6	1.78	92412.4
21	1803.0	1.78	101340.1
22	1806.4	1.78	101574.1
23	1648.6	1.78	92772.1
24	1812.8	1.78	101915.4
25	1849.4	1.78	104011.5
26	1684.4	1.78	94641.2
27	1855.9	1.78	104357.1
28	1927.1	1.78	108420.6
29	1750.6	1.78	98378.7
30	1933.7	1.78	108751.6
31	2065.7	1.78	116088.9
32	2397.5	1.78	134810.8
33	1880.8	1.78	105758.0
34	2212.6	1.78	124414.9
35	2405.2	1.78	135190.5
36	2072.6	1.78	116631.4

GEOTEC
 PO Box 14001 Richmond Road PO, Calgary AB, Canada T3E 7Y7

File results

File loads

Pile No.	Skin resistance	Tip resistance	Total load
----------	-----------------	----------------	------------

Tarut Bridge - Analysis and design of foundation

I [-]	Q _{ma} [kN]	Q _{sp} [kN]	Fr [kN]
1	2045.4	185.2	2397.5
2	2052.5	185.9	2405.2
3	1944.2	176.1	2212.6
4	1853.6	167.9	2065.7
5	1751.7	158.6	1880.8
6	1860.0	168.5	2072.6
7	1766.8	160.0	1927.1
8	1669.0	151.2	1750.6
9	1773.0	160.6	1933.7
10	1713.2	155.2	1849.4
11	1621.4	146.8	1684.4
12	1719.2	155.7	1855.9
13	1682.6	152.4	1806.4
14	1594.5	144.4	1648.6
15	1688.4	152.9	1812.8
16	1673.9	151.6	1796.5
17	1587.9	143.8	1642.6
18	1679.7	152.1	1803.0
19	1673.9	151.6	1796.5
20	1587.9	143.8	1642.6
21	1679.7	152.1	1803.0
22	1682.6	152.4	1806.4
23	1594.5	144.4	1648.6
24	1688.4	152.9	1812.8
25	1713.2	155.2	1849.4
26	1621.4	146.8	1684.4
27	1719.2	155.7	1855.9
28	1766.8	160.0	1927.1
29	1669.0	151.2	1750.6
30	1773.0	160.6	1933.7
31	1853.6	167.9	2065.7
32	2045.4	185.2	2397.5
33	1751.7	158.6	1880.8
34	1944.2	176.1	2212.6
35	2052.5	185.9	2405.2
36	1860.0	168.5	2072.6

File settlements

File No.	Self settlement S _v [cm]	Settlement S _r -S _v [cm]	Sum of settlements S _r [cm]
1	0.82	0.96	1.78
2	0.82	0.96	1.78
3	0.78	1.00	1.78
4	0.74	1.04	1.78
5	0.70	1.08	1.78
6	0.74	1.04	1.78
7	0.70	1.07	1.78
8	0.67	1.11	1.78
9	0.71	1.07	1.78
10	0.68	1.10	1.78
11	0.65	1.13	1.78
12	0.69	1.09	1.78
13	0.67	1.11	1.78
14	0.64	1.14	1.78
15	0.67	1.11	1.78

Continue of table at next page

GEOTEC

PO Box 14001 Richmond Road PO, Calgary AB, Canada T3E 7Y7

File results

Continue of table

File No.	Self settlement S _v [cm]	Settlement S _r -S _v [cm]	Sum of settlements S _r [cm]
----------	---	--	--

Tarut Bridge - Analysis and design of foundation

16	0.67	1.11	1.78
17	0.63	1.14	1.78
18	0.67	1.11	1.78
19	0.67	1.11	1.78
20	0.63	1.14	1.78
21	0.67	1.11	1.78
22	0.67	1.11	1.78
23	0.64	1.14	1.78
24	0.67	1.11	1.78
25	0.68	1.09	1.78
26	0.65	1.13	1.78
27	0.69	1.09	1.78
28	0.70	1.07	1.78
29	0.67	1.11	1.78
30	0.71	1.07	1.78
31	0.74	1.04	1.78
32	0.82	0.96	1.78
33	0.70	1.08	1.78
34	0.78	1.00	1.78
35	0.82	0.96	1.78
36	0.74	1.03	1.78

GEOTEC Office Output Sample

Tarut Bridge - Analysis and design of foundation

Method (9) (Layered soil model)
Rigid free-standing raft

y = 11.00 [m]

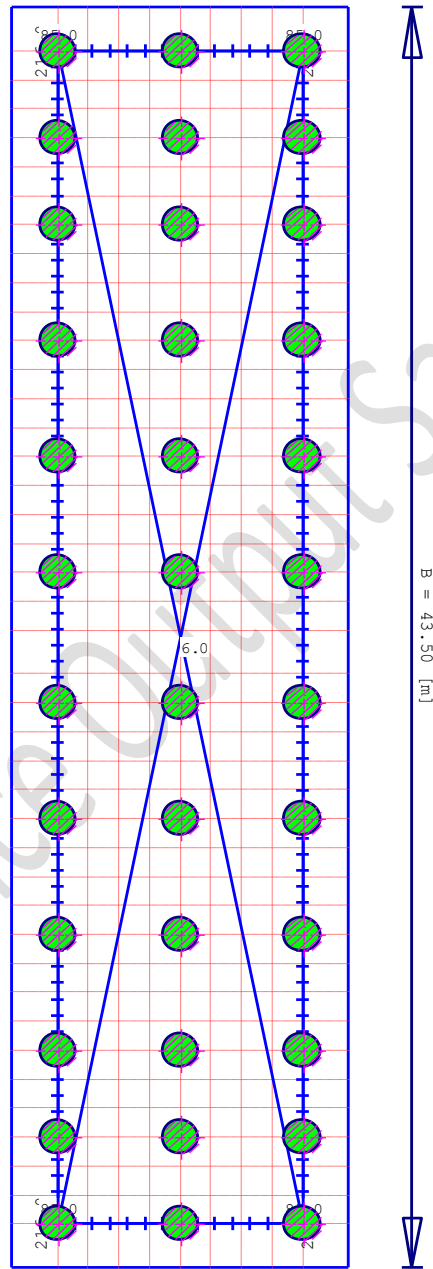
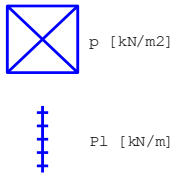

Loads

GEOTEC Software

P. O. Box 465, Port-Said, Egypt* Tel. +2066-3609247

Scale 1:230

File: Tunnel floor analysis

Page No.:

Title: Pile foundation analysis of the tunnel-left side

Date: 25/09/2010

Project: Tarut bridge, Qatif city- Saudi Arabia

Tarut Bridge - Analysis and design of foundation

Method (9) (Layered soil model)
Rigid free-standing raft

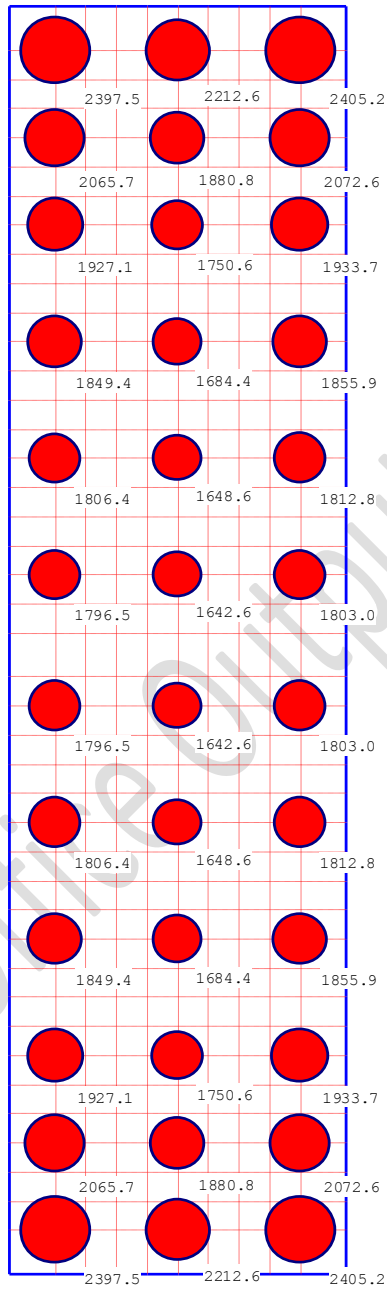

Support reactions V [kN]
Max. V = 2405.2 at node 113, Min. V = 1642.6 at node 271, Sum = 69091.5

GEOTEC Software P. O. Box 465, Port-Said, Egypt* Tel. +2066-3609247	
Scale 1:230 File: Tunnel floor analysis Page No.:	Title: Pile foundation analysis of the tunnel-left side Date: 25/09/2010 Project: Tarut bridge, Qatif city- Saudi Arabia

Method (9) (Layered soil model)
Rigid free-standing raft

1.78 [cm]
0

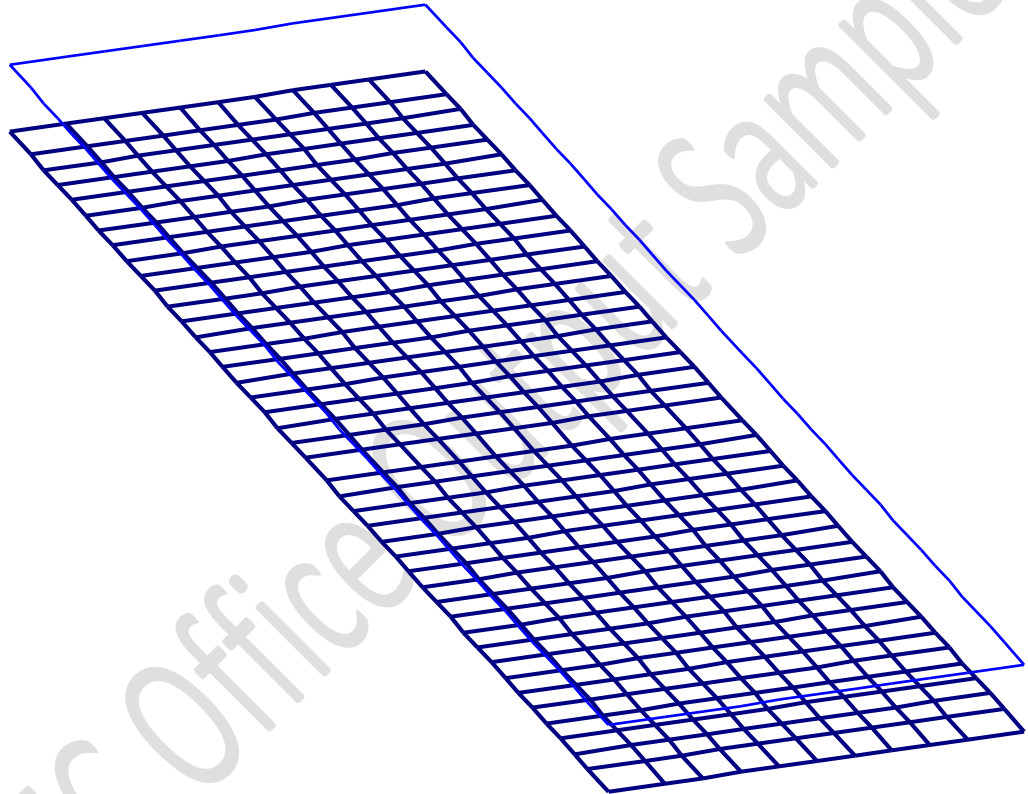

Slab deformation w [cm]
Max. w = 1.78 at node 2, Min. w = 1.78 at node 1

GEOTEC Software

P. O. Box 465, Port-Said, Egypt* Tel. +2066-3609247

Scale factor: 175

File: Tunnel floor analysis

Page No.:

Title: Pile foundation analysis of the tunnel-left side

Date: 25/09/2010

Project: Tarut bridge, Qatif city- Saudi Arabia

13 Tunnel floor design – Left side

```
*****  
Analysis of slab foundation  
by the program package ELPLA  
Version 9.2 SP1  
*****
```

Title: Pile foundation design of the tunnel-left side
Date: 25/09/2010
Project: Tarut bridge, Qatif city- Saudi Arabia
File: Tunnel floor design

Calculation method:
Method (3)
Modulus of subgrade reaction is defined by the user

Program authors Prof. M. El Gendy/ Dr. A. El Gendy
GEOTEC Software Inc. PO Box 14001 Richmond Road PO, Calgary AB, Canada T3E 7Y7
www.geotecsoftware.com; geotec@geotecsoftware.com ; Tele.:+1(587) 332-3323

Tarut Bridge - Analysis and design of foundation

PO Box 14001 Richmond Road PO, Calgary AB, Canada T3E 7Y7

Slab properties/ Foundation level/ Global coordinates

Title: Pile foundation design of the tunnel-left side
Date: 25/09/2010
Project: Tarut bridge, Qatif city- Saudi Arabia
File: Tunnel floor design

Analysis of slab foundation
by the program package ELPLA
Version 9.2 SP1

Calculation method:
Method (3)
Modulus of subgrade reaction is defined by the user

Slab properties/ Foundation level/ Global coordinates

Unit weight of slab material GB [kN/m3] = 25.0

Element groups (with the same thickness and material):

Group No.	E-Modulus of slab Ep [kN/m2]	Poisson's ratio Nue [-]	Slab thickness d [m]
1	2.4E+07	0.2	1.6

Tarut Bridge - Analysis and design of foundation

L o a d s

Title: Pile foundation design of the tunnel-left side
 Date: 25/09/2010
 Project: Tarut bridge, Qatif city- Saudi Arabia
 File: Tunnel floor design

Analysis of slab foundation
 by the program package ELPLA
 Version 9.2 SP1

Calculation method:
 Method (3)
 Modulus of subgrade reaction is defined by the user

L o a d i n g

Line loads:

Load No.	Load start value	Load end value	Load start	Load start	Load end	Load end
I	P1	P1	x1	y1	x2	y2
[-]	[kN/m]	[kN/m]	[m]	[m]	[m]	[m]
1	216	216	1.5	42	1.5	1.5
2	218	218	9.5	1.5	9.5	42
3	85	85	1.5	42	9.5	42
4	85	85	1.5	1.5	9.5	1.5

Distributed loads (Rectangle):

Load No.	Load value	Load start	Load start	Load end	Load end
I	P	x1	y1	x2	y2
[-]	[kN/m2]	[m]	[m]	[m]	[m]
1	6	1.5	42	9.5	1.5

Tarut Bridge - Analysis and design of foundation

Loads

Loading data:

Distribute column loads: (Yes)

Slab weight	Pe [kN]	= 19140.0
Force on slab	Pa [kN]	= 49381.5
Groundwater force	Pw [kN]	= 0.0
Total load ($P = Pe + Pa - Pw$)	P [kN]	= 68521.5
Groundwater pressure on raft	Qw [kN/m ²]	= 0.0
Average contact pressure	Qo [kN/m ²]	= 143.2

Sum Mx from loads	Mx [kN.m]	= 0.0
Sum My from loads	My [kN.m]	= 324.0

Eccentricity of loading in x-direction	ex [cm]	= 0.47
Eccentricity of loading in y-direction	ey [cm]	= 0.00

Moment of inertia of slab about x-Axis	Ix [m ⁴]	= 75453.28
Moment of inertia of slab about y-Axis	Iy [m ⁴]	= 4824.86
Product of inertia	Ixy [m ⁴]	= 0.00
Area of the slab	A [m ²]	= 478.50
Volume of the slab	V [m ³]	= 765.60

GEOTEC

PO Box 14001 Richmond Road PO, Calgary AB, Canada T3E 7Y7

Data of reinforcement

Tarut Bridge - Analysis and design of foundation

Title: Pile foundation design of the tunnel-left side
Date: 25/09/2010
Project: Tarut bridge, Qatif city- Saudi Arabia
File: Tunnel floor design

Analysis of slab foundation
by the program package ELPLA
Version 9.2 SP1

Calculation method:
Method (3)
Modulus of subgrade reaction is defined by the user

Data of reinforcement (Design for flexural moment)

Design Code
Concrete grade C 300
Steel Grade S 36/52

Compressive strength	fc	[kN/m ²]	=	10500
Tensile strength	fs	[kN/m ²]	=	200000

Concrete cover+ 1/2 bar diameter				
X-direction top	d1x	[cm]	=	7
X-direction bottom	d2x	[cm]	=	7
Y-direction top	d1y	[cm]	=	7
Y-direction bottom	d2y	[cm]	=	7

GEOTEC

PO Box 14001 Richmond Road PO, Calgary AB, Canada T3E 7Y7

Data of piles

Tarut Bridge - Analysis and design of foundation

Title: Pile foundation design of the tunnel-left side
 Date: 25/09/2010
 Project: Tarut bridge, Qatif city- Saudi Arabia
 File: Tunnel floor design

Analysis of slab foundation
 by the program package ELPLA
 Version 9.2 SP1

Calculation method:
 Method (3)
 Modulus of subgrade reaction is defined by the user

File groups:

Group No.	Pile diameter	Pile length	Pile stiffness
I	D	L	kz
[-]	[m]	[m]	[kN/m]
1	1.20	28.00	134691.0
2	1.20	28.00	116051.0
3	1.20	28.00	108264.0
4	1.20	28.00	103899.0
5	1.20	28.00	101483.0
6	1.20	28.00	100928.0
7	1.20	28.00	124303.0
8	1.20	28.00	105663.0
9	1.20	28.00	98348.0
10	1.20	28.00	94629.0
11	1.20	28.00	92618.0
12	1.20	28.00	92281.0
13	1.20	28.00	135124.0
14	1.20	28.00	116438.0
15	1.20	28.00	108635.0
16	1.20	28.00	104264.0
17	1.20	28.00	101843.0
18	1.20	28.00	101292.0

Pile locations and groups:

Pile No.	Node No.	X-coord.	Y-coord.	Group No.
[-]	[-]	[m]	[m]	[-]
1	105	1.50	1.50	1
2	465	1.50	42.00	1
3	438	1.50	39.00	2
4	132	1.50	4.50	2
5	159	1.50	7.50	3
6	411	1.50	36.00	3
7	195	1.50	11.50	4
8	375	1.50	32.00	4
9	231	1.50	15.50	5
10	339	1.50	28.00	5
11	267	1.50	19.50	6
12	303	1.50	24.00	6
13	109	5.50	1.50	7
14	469	5.50	42.00	7
15	442	5.50	39.00	8

Continue of table at next page

GEOTEC
 PO Box 14001 Richmond Road PO, Calgary AB, Canada T3E 7Y7

Data of piles

Continue of table

Tarut Bridge - Analysis and design of foundation

File No. [-]	Node No. [-]	X-coord. [m]	Y-coord. [m]	Group No. [-]
19	379	5.50	32.00	10
20	199	5.50	11.50	10
21	235	5.50	15.50	11
22	343	5.50	28.00	11
23	307	5.50	24.00	12
24	271	5.50	19.50	12
25	113	9.50	1.50	13
26	473	9.50	42.00	13
27	446	9.50	39.00	14
28	140	9.50	4.50	14
29	419	9.50	36.00	15
30	167	9.50	7.50	15
31	383	9.50	32.00	16
32	203	9.50	11.50	16
33	347	9.50	28.00	17
34	239	9.50	15.50	17
35	311	9.50	24.00	18
36	275	9.50	19.50	18

File material:

Modulus of elasticity of pile Ep [kN/m²] = 24000000.00

Unit weight of pile concrete GP [kN/m³] = 25.50

(Including 1 m pile length above the sea bed)

GEOTEC

PO Box 14001 Richmond Road PO, Calgary AB, Canada T3E 7Y7

Support reactions

Title: Pile foundation design of the tunnel-left side

Date: 25/09/2010

Tarut Bridge - Analysis and design of foundation

Project: Tarut bridge, Qatif city- Saudi Arabia
File: Tunnel floor design

Analysis of slab foundation
by the program package ELPLA
Version 9.2 SP1

Calculation method:
Method (3)
Modulus of subgrade reaction is defined by the user

Support reactions

Node No.	Load-V	Moment-Y	Moment-X
I	V	My	Mx
[-]	[kN]	[kN.m]	[kN.m]
105	1834.3	0.0	0.0
109	1687.7	0.0	0.0
113	1839.0	0.0	0.0
132	1798.0	0.0	0.0
136	1628.2	0.0	0.0
140	1803.0	0.0	0.0
159	1867.8	0.0	0.0
163	1685.3	0.0	0.0
167	1873.4	0.0	0.0
195	1995.4	0.0	0.0
199	1803.8	0.0	0.0
203	2001.7	0.0	0.0
231	2085.0	0.0	0.0
235	1888.4	0.0	0.0
239	2091.6	0.0	0.0
267	2145.2	0.0	0.0
271	1946.2	0.0	0.0
275	2151.6	0.0	0.0
303	2145.8	0.0	0.0
307	1946.2	0.0	0.0
311	2151.0	0.0	0.0
339	2086.1	0.0	0.0
343	1888.4	0.0	0.0
347	2090.4	0.0	0.0
375	1996.4	0.0	0.0
379	1803.4	0.0	0.0
383	1999.8	0.0	0.0
411	1868.5	0.0	0.0
415	1684.3	0.0	0.0
419	1870.7	0.0	0.0
438	1798.2	0.0	0.0
442	1626.7	0.0	0.0
446	1799.6	0.0	0.0
465	1833.7	0.0	0.0
469	1685.3	0.0	0.0
473	1834.3	0.0	0.0

Sum. V 68234.5

GEOTEC
PO Box 14001 Richmond Road PO, Calgary AB, Canada T3E 7Y7

File results

Title: File foundation design of the tunnel-left side
Date: 25/09/2010
Project: Tarut bridge, Qatif city- Saudi Arabia

Tarut Bridge - Analysis and design of foundation

File: Tunnel floor design

Analysis of slab foundation
by the program package ELPLA
Version 9.2 SP1

Calculation method:

Method (3)

Modulus of subgrade reaction is defined by the user

File results

Value of total load (including own wt.)		Po	[kN] = 68521.5
Total pile loads		PL	[kN] = 68234.5
Bearing factor of piled raft		Alfa-Kpp	[%] = 99.58

File loads and displacements

File No.	pile load Fr [kN]	Settlement Sr [cm]	Soil stiffness ks [kN/m]
1	1834.3	1.36	134691.0
2	1833.7	1.36	134691.0
3	1798.2	1.55	116051.0
4	1798.0	1.55	116051.0
5	1867.8	1.73	108264.0
6	1868.5	1.73	108264.0
7	1995.4	1.92	103899.0
8	1996.4	1.92	103899.0
9	2085.0	2.05	101483.0
10	2086.1	2.06	101483.0
11	2145.2	2.13	100928.0
12	2145.8	2.13	100928.0
13	1687.7	1.36	124303.0
14	1685.3	1.36	124303.0
15	1626.7	1.54	105663.0
16	1628.2	1.54	105663.0
17	1684.3	1.71	98348.0
18	1685.3	1.71	98348.0
19	1803.4	1.91	94629.0
20	1803.8	1.91	94629.0
21	1888.4	2.04	92618.0
22	1888.4	2.04	92618.0
23	1946.2	2.11	92281.0
24	1946.2	2.11	92281.0
25	1839.0	1.36	135124.0
26	1834.3	1.36	135124.0
27	1799.6	1.55	116438.0
28	1803.0	1.55	116438.0
29	1870.7	1.72	108635.0
30	1873.4	1.72	108635.0
31	1999.8	1.92	104264.0
32	2001.7	1.92	104264.0
33	2090.4	2.05	101843.0
34	2091.6	2.05	101843.0
35	2151.0	2.12	101292.0
36	2151.6	2.12	101292.0

Tarut Bridge - Analysis and design of foundation

Punching Shear

Node No.	Load value	X-coord.	Y-coord.	Pile diameter	Punching shear stress	Stress on the column	Area of critical section of punching shear PA [m ²]	Perimeter of critical section of punching shear AL [m]	Effective depth of the section of punching shear Dp [m]	Punching shear stress ratio
I [-]	Pc [kN]	Xc [m]	Yc [m]	a [m]	Qp [kN/m ²]	Qo [kN/m ²]				Rpa [%]
1	1834.3	1.5	1.5	1.2	122.5	41.5	5.7	8.52	1.53	4.08
2	1833.7	1.5	42	1.2	122.5	41.5	5.7	8.52	1.53	4.08
3	1798.2	1.5	39	1.2	119.1	43	5.7	8.52	1.53	4.2
4	1798	1.5	4.5	1.2	119.1	43	5.7	8.52	1.53	4.2
5	1867.8	1.5	7.5	1.2	124.4	43	5.7	8.52	1.53	4.02
6	1868.5	1.5	36	1.2	124.5	43	5.7	8.52	1.53	4.02
7	1995.4	1.5	11.5	1.2	134.2	43	5.7	8.52	1.53	3.72
8	1996.4	1.5	32	1.2	134.3	43	5.7	8.52	1.53	3.72
9	2085	1.5	15.5	1.2	141.1	43	5.7	8.52	1.53	3.54
10	2086.1	1.5	28	1.2	141.2	43	5.7	8.52	1.53	3.54
11	2145.2	1.5	19.5	1.2	145.7	43	5.7	8.52	1.53	3.43
12	2145.8	1.5	24	1.2	145.8	43	5.7	8.52	1.53	3.43
13	1687.7	5.5	1.5	1.2	110.6	43	5.7	8.52	1.53	4.52
14	1685.3	5.5	42	1.2	110.4	43	5.7	8.52	1.53	4.53
15	1626.7	5.5	39	1.2	104.6	46	5.7	8.52	1.53	4.78
16	1628.2	5.5	4.5	1.2	104.8	46	5.7	8.52	1.53	4.77
17	1684.3	5.5	36	1.2	109.1	46	5.7	8.52	1.53	4.58
18	1685.3	5.5	7.5	1.2	109.1	46	5.7	8.52	1.53	4.58

Tarut Bridge - Analysis and design of foundation

Node No.	Load value	X-coord.	Y-coord.	Pile diameter	Punching shear stress	Stress on the column	Area of critical section of punching shear	Perimeter of critical section of punching shear	Effective depth of the section of punching shear	Punching shear stress ratio
I [-]	Pc [kN]	Xc [m]	Yc [m]	a [m]	Qp [kN/m ²]	Qo [kN/m ²]	PA [m ²]	AL [m]	Dp [m]	Rpa [%]
19	1803.4	5.5	32	1.2	118.2	46	5.7	8.52	1.53	4.23
20	1803.8	5.5	11.5	1.2	118.2	46	5.7	8.52	1.53	4.23
21	1888.4	5.5	15.5	1.2	124.7	46	5.7	8.52	1.53	4.01
22	1888.4	5.5	28	1.2	124.7	46	5.7	8.52	1.53	4.01
23	1946.2	5.5	24	1.2	129.1	46	5.7	8.52	1.53	3.87
24	1946.2	5.5	19.5	1.2	129.1	46	5.7	8.52	1.53	3.87
25	1839	9.5	1.5	1.2	122.9	41.5	5.7	8.52	1.53	4.07
26	1834.3	9.5	42	1.2	122.5	41.5	5.7	8.52	1.53	4.08
27	1799.6	9.5	39	1.2	119.2	43	5.7	8.52	1.53	4.19
28	1803	9.5	4.5	1.2	119.5	43	5.7	8.52	1.53	4.18
29	1870.7	9.5	36	1.2	124.7	43	5.7	8.52	1.53	4.01
30	1873.4	9.5	7.5	1.2	124.9	43	5.7	8.52	1.53	4
31	1999.8	9.5	32	1.2	134.6	43	5.7	8.52	1.53	3.72
32	2001.7	9.5	11.5	1.2	134.7	43	5.7	8.52	1.53	3.71
33	2090.4	9.5	28	1.2	141.5	43	5.7	8.52	1.53	3.53
34	2091.6	9.5	15.5	1.2	141.6	43	5.7	8.52	1.53	3.53
35	2151	9.5	24	1.2	146.2	43	5.7	8.52	1.53	3.42
36	2151.6	9.5	19.5	1.2	146.2	43	5.7	8.52	1.53	3.42

Tarut Bridge - Analysis and design of foundation

Method (2)

Modulus of subgrade reaction is defined by the user

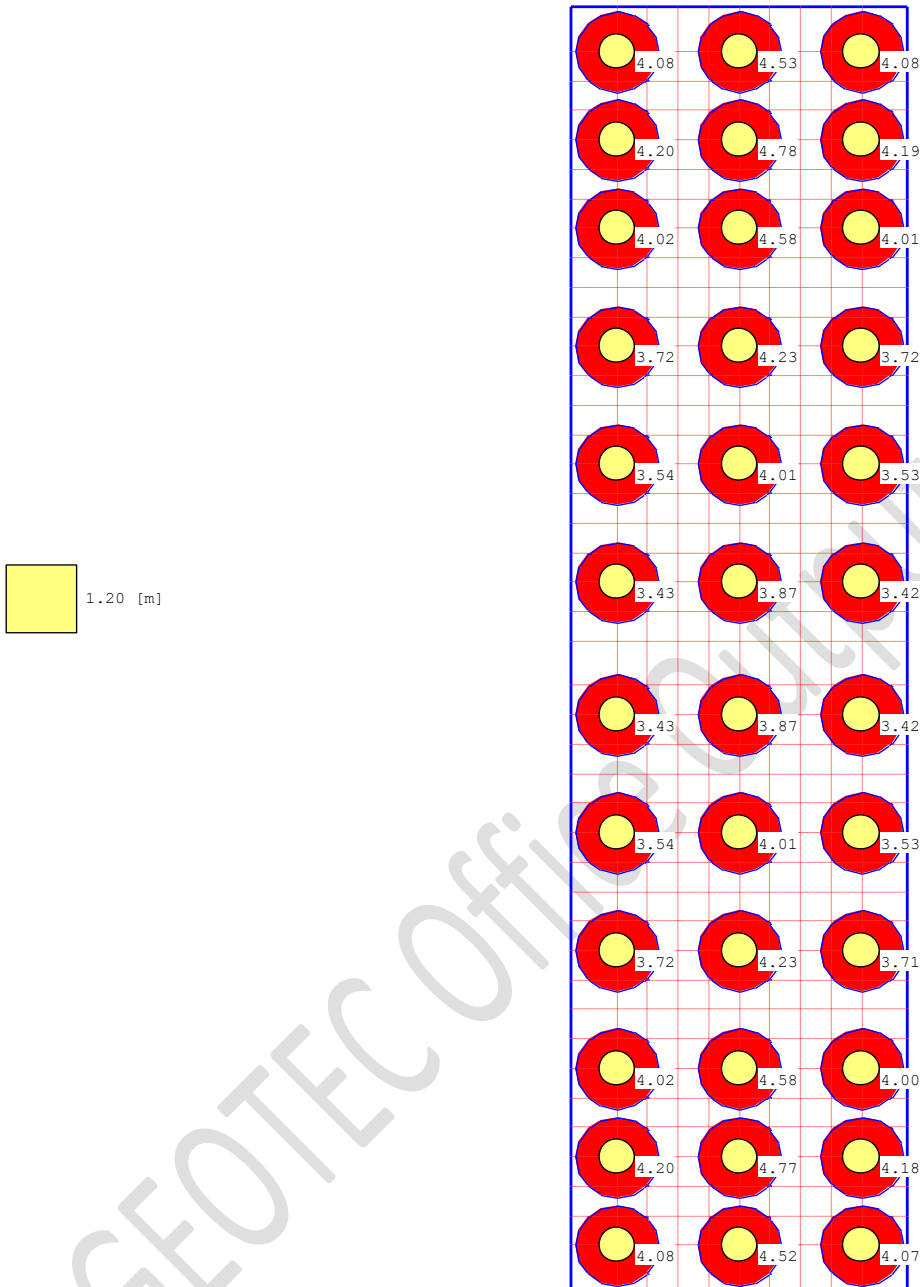

Punching shear stress ratio R_{pa} [%]

Max. R_{pa} = 4.78 at column 15, Min. R_{pa} = 3.42 at column 36

GEOTEC Software

P. O. Box 465, Port-Said, Egypt* Tel. +2066-3609247

Scale 1:230

File: Tunnel floor design

Page No. :

Title: Pile foundation design of the tunnel-left side

Date: 25/09/2010

Project: Tarut bridge, Qatif city- Saudi Arabia

Tarut Bridge - Analysis and design of foundation

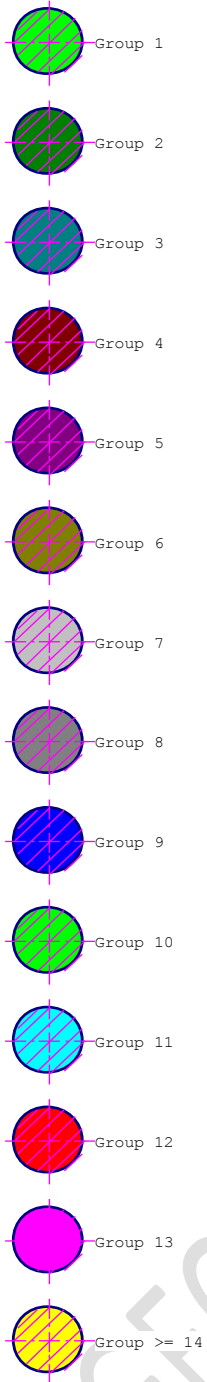

Method (2)

Modulus of subgrade reaction is defined by the user

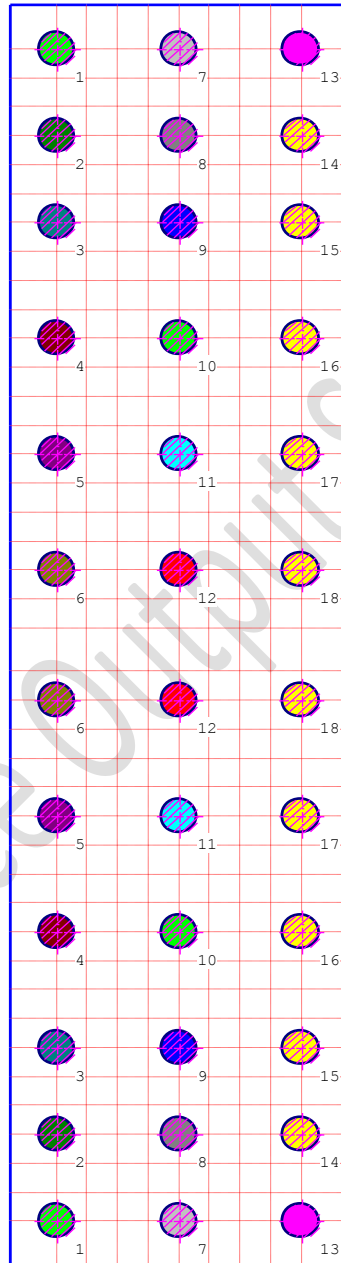

Pile locations and groups
No. of pile groups = 18

GEOTEC Software

P. O. Box 465, Port-Said, Egypt* Tel. +2066-3609247

Scale 1:230

File: Tunnel floor design

Page No. :

Title: Pile foundation design of the tunnel-left side

Date: 25/09/2010

Project: Tarut bridge, Qatif city- Saudi Arabia

Tarut Bridge - Analysis and design of foundation

Method (2)

Modulus of subgrade reaction is defined by the user

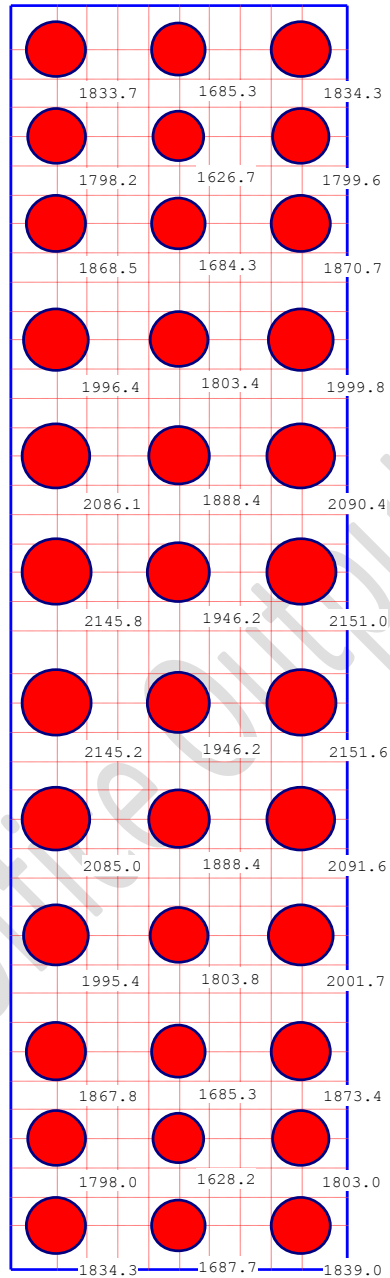

Support reactions V [kN]

Max. $V = 2151.6$ at node 275, Min. $V = 1626.7$ at node 442, Sum = 68234.5

GEOTEC Software

P. O. Box 465, Port-Said, Egypt* Tel. +2066-3609247

Scale 1:230

File: Tunnel floor design

Page No. :

Title: Pile foundation design of the tunnel-left side

Date: 25/09/2010

Project: Tarut bridge, Qatif city- Saudi Arabia

Tarut Bridge - Analysis and design of foundation

Method (2)

Modulus of subgrade reaction is defined by the user

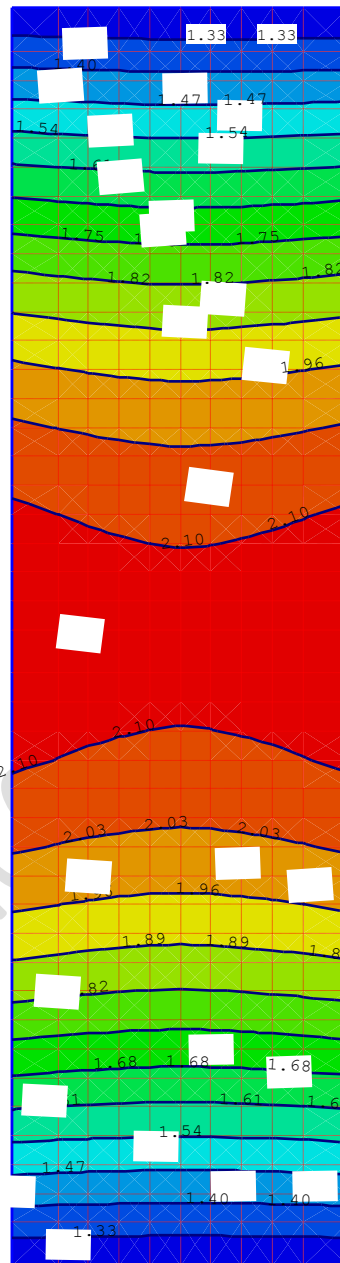
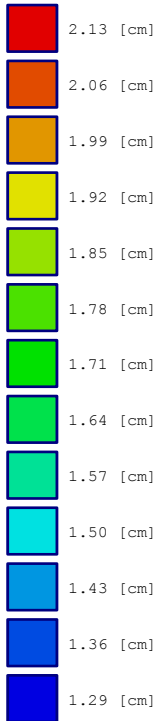

Settlements [cm]

Max. $s = 2.15$ at node 84, Min. $s = 1.26$ at node 58

GEOTEC Software

P. O. Box 465, Port-Said, Egypt* Tel. +2066-3609247

Scale 1:230

File: Tunnel floor design

Page No.:

Title: Pile foundation design of the tunnel-left side

Date: 25/09/2010

Project: Tarut bridge, Qatif city- Saudi Arabia

Tarut Bridge - Analysis and design of foundation

Method (2)

Modulus of subgrade reaction is defined by the user

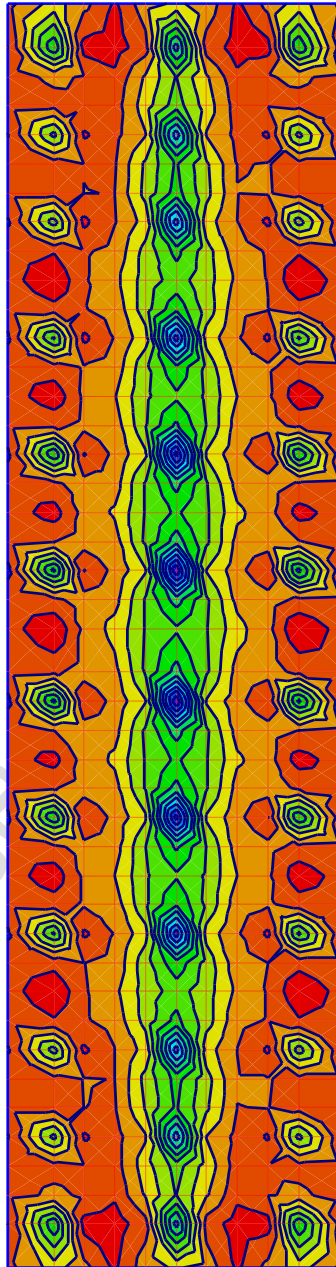
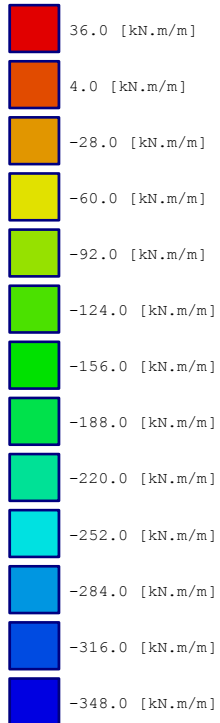

Moments m_x [kN.m/m]

Max. m_x = 52.0 at node 293, Min. m_x = -364.0 at node 307

GEOTEC Software

P. O. Box 465, Port-Said, Egypt* Tel. +2066-3609247

Scale 1:230

File: Tunnel floor design

Page No. :

Title: Pile foundation design of the tunnel-left side

Date: 25/09/2010

Project: Tarut bridge, Qatif city- Saudi Arabia

Tarut Bridge - Analysis and design of foundation

Method (2)

Modulus of subgrade reaction is defined by the user

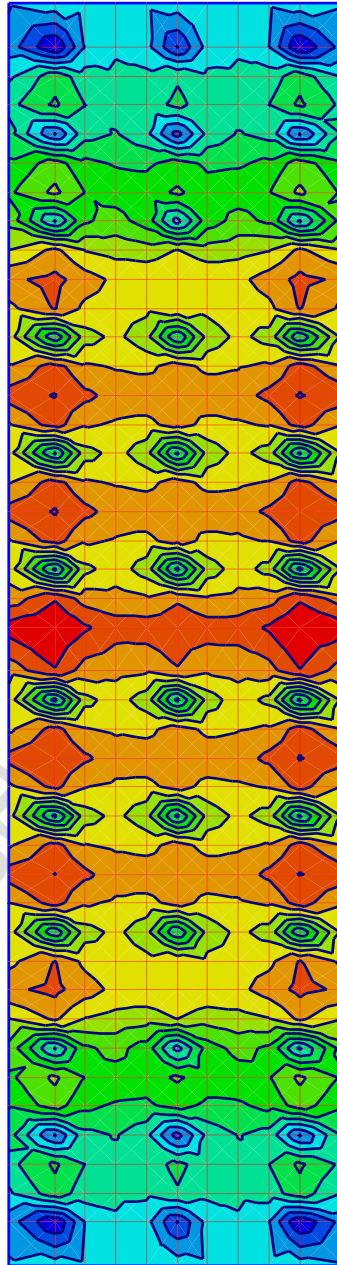
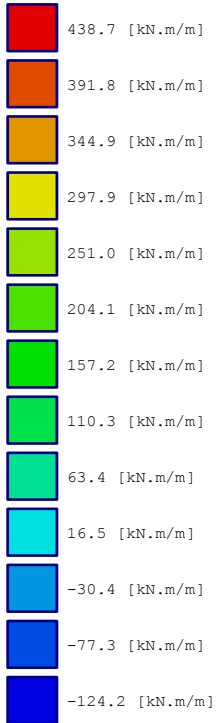

Moments m_y [kN.m/m]

Max. $m_y = 461.9$ at node 293, Min. $m_y = -147.6$ at node 113

GEOTEC Software

P. O. Box 465, Port-Said, Egypt* Tel. +2066-3609247

Scale 1:230

File: Tunnel floor design

Page No. :

Title: Pile foundation design of the tunnel-left side

Date: 25/09/2010

Project: Tarut bridge, Qatif city- Saudi Arabia

Tarut Bridge - Analysis and design of foundation

Method (2)

Modulus of subgrade reaction is defined by the user

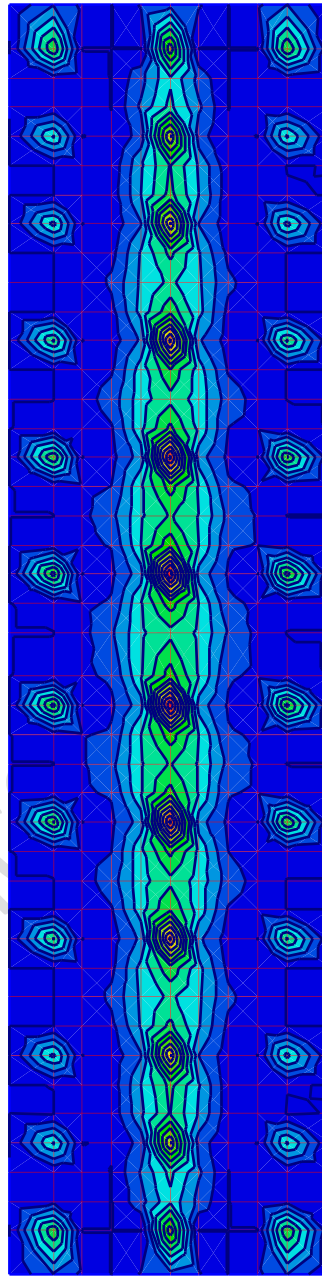
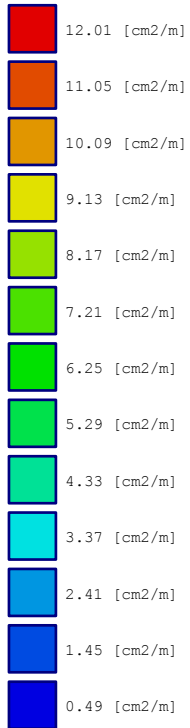

Top reinforcement in x-direction A_{s_topx} [cm²/m]

Max. A_{s_topx} = 12.50 at node 307, Min. A_{s_topx} = 0.01 at node 19

GEOTEC Software

P. O. Box 465, Port-Said, Egypt* Tel. +2066-3609247

Scale 1:230

File: Tunnel floor design

Page No. :

Title: Pile foundation design of the tunnel-left side

Date: 25/09/2010

Project: Tarut bridge, Qatif city- Saudi Arabia

Tarut Bridge - Analysis and design of foundation

Method (2)

Modulus of subgrade reaction is defined by the user

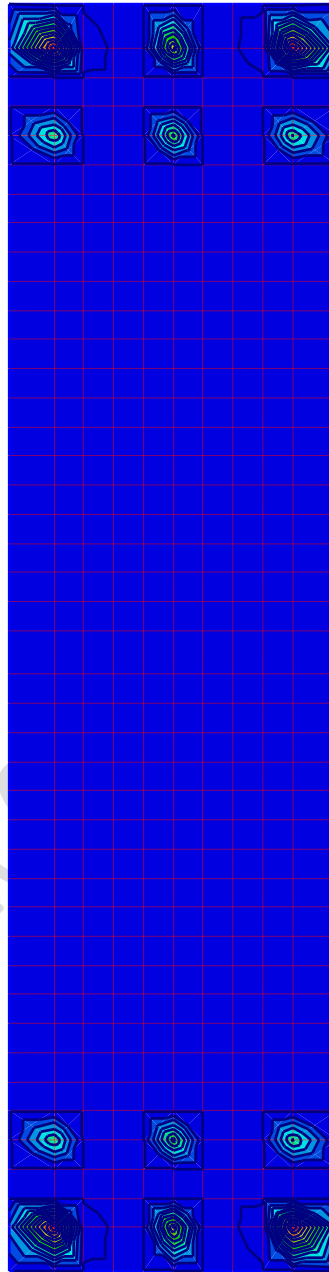
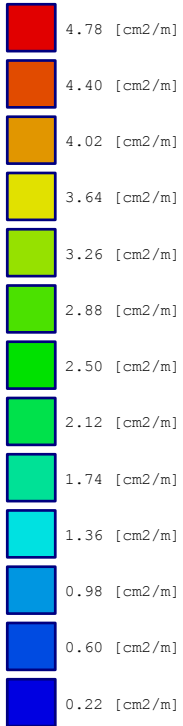

Top reinforcement in y-direction A_{s_topy} [cm2/m]

Max. A_{s_topy} = 4.97 at node 113, Min. A_{s_topy} = 0.03 at node 3

GEOTEC Software

P. O. Box 465, Port-Said, Egypt* Tel. +2066-3609247

Scale 1:230

File: Tunnel floor design

Page No. :

Title: Pile foundation design of the tunnel-left side

Date: 25/09/2010

Project: Tarut bridge, Qatif city- Saudi Arabia

Method (2)

Modulus of subgrade reaction is defined by the user

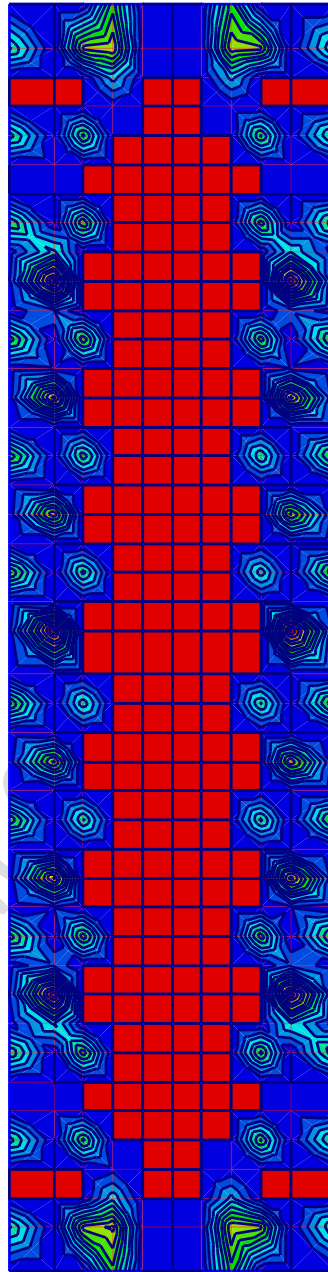
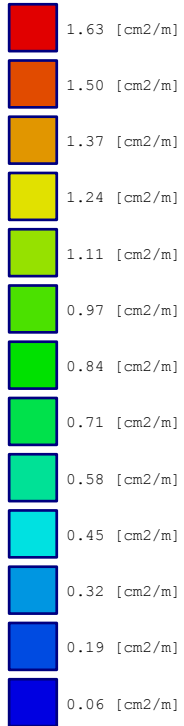

Bottom reinforcement in x-direction A_{s_botx} [cm2/m]

Max. A_{s_botx} = 1.73 at node 293, Min. A_{s_botx} = 0.00 at node 33

GEOTEC Software

P. O. Box 465, Port-Said, Egypt* Tel. +2066-3609247

Scale 1:230

File: Tunnel floor design

Page No. :

Title: Pile foundation design of the tunnel-left side

Date: 25/09/2010

Project: Tarut bridge, Qatif city- Saudi Arabia

Method (2)

Modulus of subgrade reaction is defined by the user

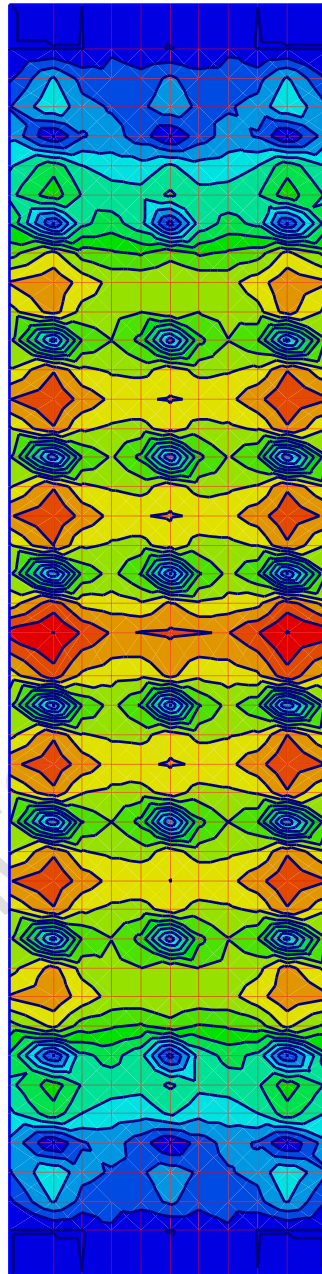
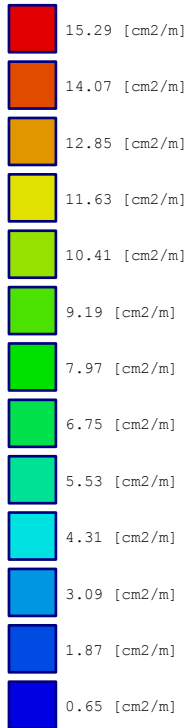

Bottom reinforcement in y-direction A_{s_boty} [cm²/m]

Max. A_{s_boty} = 15.96 at node 293, Min. A_{s_boty} = 0.04 at node 62

GEOTEC Software

P. O. Box 465, Port-Said, Egypt* Tel. +2066-3609247

Scale 1:230

File: Tunnel floor design

Page No. :

Title: Pile foundation design of the tunnel-left side

Date: 25/09/2010

Project: Tarut bridge, Qatif city- Saudi Arabia

Method (2)

Modulus of subgrade reaction is defined by the user

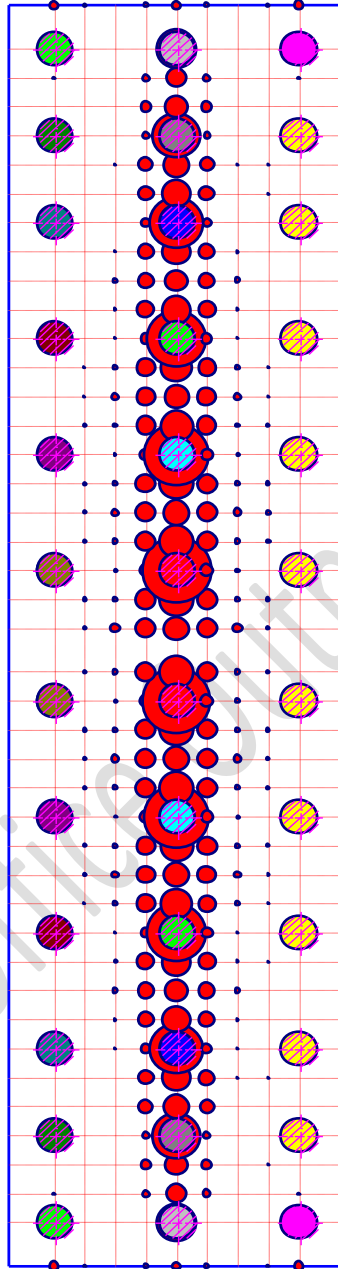

Top reinforcement in x-direction A_{s_topx} [cm²/m]

Max. A_{s_topx} = 12.50 at node 307, Min. A_{s_topx} = 0.01 at node 19

GEOTEC Software

P. O. Box 465, Port-Said, Egypt* Tel. +2066-3609247

Scale 1:230

File: Tunnel floor design

Page No. :

Title: Pile foundation design of the tunnel-left side

Date: 25/09/2010

Project: Tarut bridge, Qatif city- Saudi Arabia

Tarut Bridge - Analysis and design of foundation

Method (2)

Modulus of subgrade reaction is defined by the user

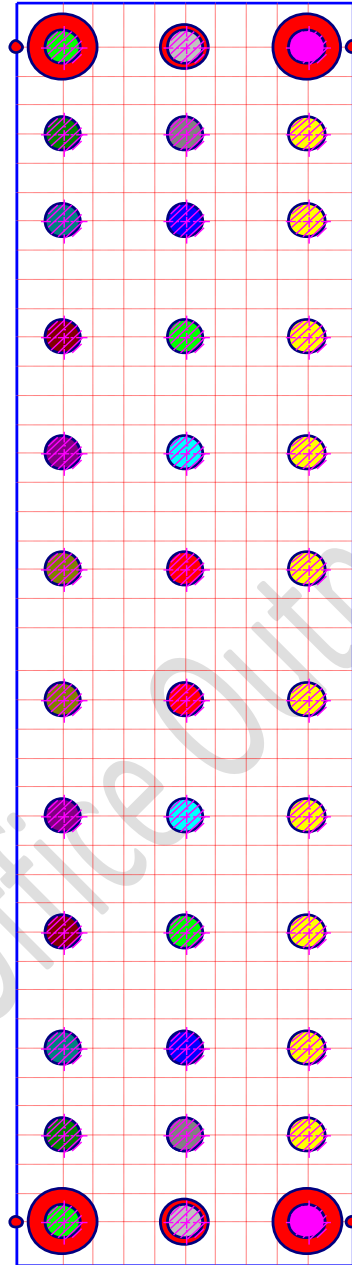

Top reinforcement in y-direction A_{s_topy} [cm²/m]

Max. A_{s_topy} = 4.97 at node 113, Min. A_{s_topy} = 0.03 at node 3

GEOTEC Software

P. O. Box 465, Port-Said, Egypt* Tel. +2066-3609247

Scale 1:230

File: Tunnel floor design

Page No. :

Title: Pile foundation design of the tunnel-left side

Date: 25/09/2010

Project: Tarut bridge, Qatif city- Saudi Arabia

Method (2)

Modulus of subgrade reaction is defined by the user

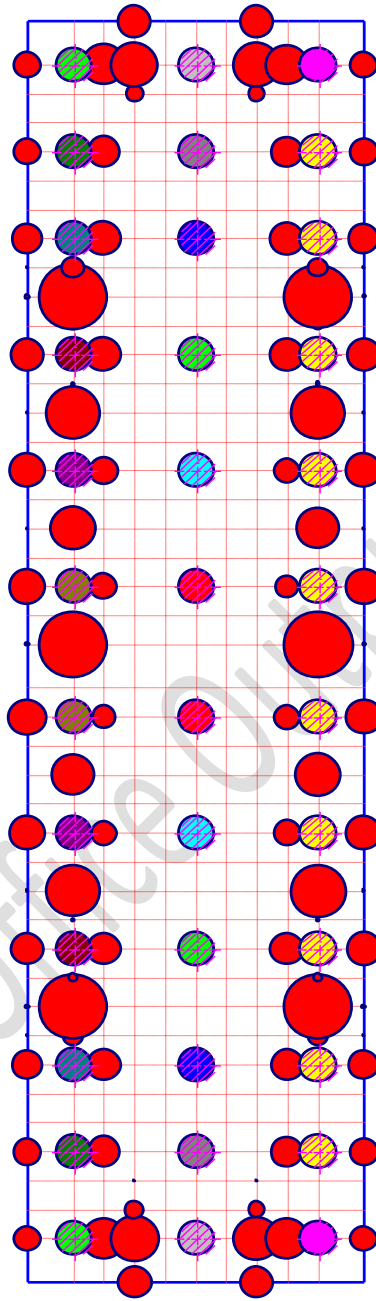

Bottom reinforcement in x-direction A_{s_botx} [cm²/m]

Max. A_{s_botx} = 1.73 at node 293, Min. A_{s_botx} = 0.00 at node 33

GEOTEC Software

P. O. Box 465, Port-Said, Egypt* Tel. +2066-3609247

Scale 1:230

File: Tunnel floor design

Page No. :

Title: Pile foundation design of the tunnel-left side

Date: 25/09/2010

Project: Tarut bridge, Qatif city- Saudi Arabia

Method (2)

Modulus of subgrade reaction is defined by the user

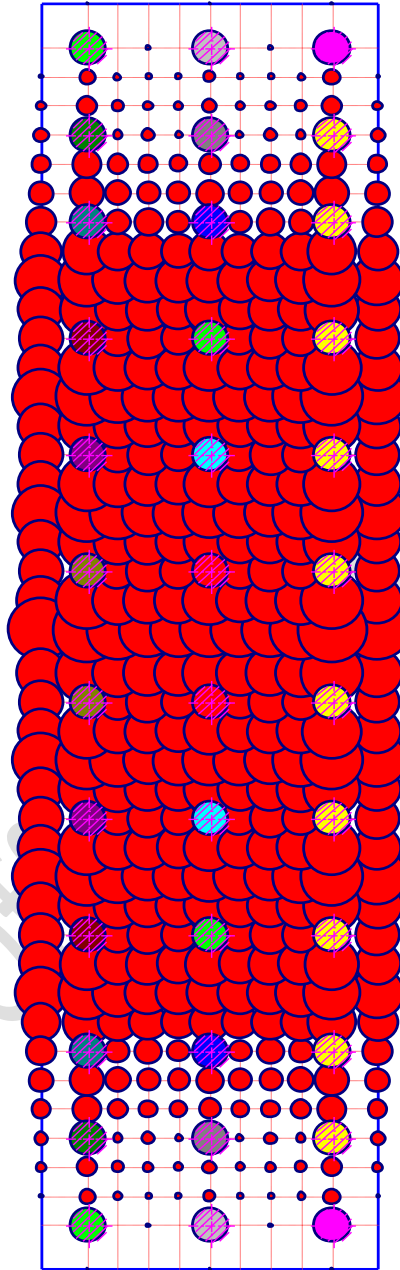

Bottom reinforcement in y-direction A_{s_boty} [cm²/m]

Max. A_{s_boty} = 15.96 at node 293, Min. A_{s_boty} = 0.04 at node 62

GEOTEC Software

P. O. Box 465, Port-Said, Egypt* Tel. +2066-3609247

Scale 1:230

File: Tunnel floor design

Page No.:

Title: Pile foundation design of the tunnel-left side

Date: 25/09/2010

Project: Tarut bridge, Qatif city- Saudi Arabia

14 Check for uplift - Left tunnel

This section has be omitted

15 Tunnel floor analysis – Right side

```
*****
                          Analysis of slab foundation
                          by the program package ELPLA
                          Version 9.2 SP1
*****
```

Title: Pile foundation analysis of the tunnel-right side
Date: 25/09/2010
Project: Tarut bridge, Qatif city- Saudi Arabia
File: Tunnel floor analysis

Calculation method:
Method (9) (Layered soil model)
Rigid free-standing raft

Program authors Prof. M. El Gendy/ Dr. A. El Gendy
GEOTEC Software Inc. PO Box 14001 Richmond Road PO, Calgary AB, Canada T3E 7Y7
www.geotecsoftware.com; geotec@geotecsoftware.com ; Tele.:+1(587) 332-3323

Tarut Bridge - Analysis and design of foundation

GEOTEC

PO Box 14001 Richmond Road PO, Calgary AB, Canada T3E 7Y7

Soil data

Title: Pile foundation analysis of the tunnel-right side

Date: 25/09/2010

Project: Tarut bridge, Qatif city- Saudi Arabia

File: Tunnel floor analysis

Analysis of slab foundation
by the program package ELPLA
Version 9.2 SP1

Calculation method:

Method (9) (Layered soil model)

Rigid free-standing raft

Soil data

Groundwater depth under the ground surface

GW [m] = 0

Settlement reduction factor

Alfa [-] = 1

Boring layers

Boring log No.: 1

Boring Log Label: B1

Location of boring in global coordinates system

Xb [m] = 0.00

Yb [m] = 0.00

Layer No.: 1

Symbole for soil type and rocks after DIN 4023: S+U

Level of layer under ground

z [m] = 5.50

Modulus of Elasticity of the soil (Loading)

E [kN/m²] = 18500

Modulus of Elasticity of the soil (Reloading)

W [kN/m²] = 18500

Poisson's ratio of soil

Nue [-] = 0

Unit weight of the soil

Gama [kN/m³] = 6.2

Angle of internal friction

Fhi [°] = 30.00

Cohesion of the soil

c [kN/m²] = 0

Layer No.: 2

Symbole for soil type and rocks after DIN 4023: T

Level of layer under ground

z [m] = 10.00

Modulus of Elasticity of the soil (Loading)

E [kN/m²] = 10000

Modulus of Elasticity of the soil (Reloading)

W [kN/m²] = 10000

Poisson's ratio of soil

Nue [-] = 0

Unit weight of the soil

Gama [kN/m³] = 5.2

Angle of internal friction

Fhi [°] = 0.00

Cohesion of the soil

c [kN/m²] = 75

Layer No.: 3

Symbole for soil type and rocks after DIN 4023: S+U

Level of layer under ground

z [m] = 30.00

Modulus of Elasticity of the soil (Loading)

E [kN/m²] = 43000

Modulus of Elasticity of the soil (Reloading)

W [kN/m²] = 43000

Poisson's ratio of soil

Nue [-] = 0

Unit weight of the soil

Gama [kN/m³] = 9.2

Angle of internal friction

Fhi [°] = 36.00

Cohesion of the soil

c [kN/m²] = 0

Layer No.: 4

Symbole for soil type and rocks after DIN 4023: T

Level of layer under ground

z [m] = 50.00

Modulus of Elasticity of the soil (Loading)

E [kN/m²] = 47000

Modulus of Elasticity of the soil (Reloading)

W [kN/m²] = 47000

Poisson's ratio of soil

Nue [-] = 0

Unit weight of the soil

Gama [kN/m³] = 9.7

Angle of internal friction

Fhi [°] = 0.00

Cohesion of the soil

c [kN/m²] = 200

GEOTEC

Tarut Bridge - Analysis and design of foundation

PO Box 14001 Richmond Road PO, Calgary AB, Canada T3E 7Y7

Slab properties/ Foundation level/ Global coordinates

Title: Pile foundation analysis of the tunnel-right side

Date: 25/09/2010

Project: Tarut bridge, Qatif city- Saudi Arabia

File: Tunnel floor analysis

Analysis of slab foundation
by the program package ELPLA
Version 9.2 SP1

Calculation method:

Method (9) (Layered soil model)

Rigid free-standing raft

Slab properties/ Foundation level/ Global coordinates

Unit weight of slab material GB [kN/m3] = 25.0

Element groups (with the same thickness and material):

Group No.	E-Modulus of slab Ep [kN/m2]	Poisson's ratio Nue [-]	Slab thickness d [m]
1	2.4E+07	0.2	1.6

GEOTEC

PO Box 14001 Richmond Road PO, Calgary AB, Canada T3E 7Y7

Tarut Bridge - Analysis and design of foundation

Loads

Title: Pile foundation analysis of the tunnel-right side
 Date: 25/09/2010
 Project: Tarut bridge, Qatif city- Saudi Arabia
 File: Tunnel floor analysis

Analysis of slab foundation
 by the program package ELPLA
 Version 9.2 SP1

Calculation method:
 Method (9) (Layered soil model)
 Rigid free-standing raft

Loading

Line loads:

Load No.	Load start value	Load end value	Load start	Load start	Load end	Load end
I	P1	P1	x1	y1	x2	y2
[-]	[kN/m]	[kN/m]	[m]	[m]	[m]	[m]
1	85	85	1.5	1.5	9.5	1.5
2	85	85	18.46	63.11	24.36	57.71
3	172.5	172.5	1.5	1.5	1.5	44.5
4	172.5	172.5	1.5	44.5	18.46	63.11
5	186	186	9.5	1.5	9.5	41.5
6	186	186	9.5	41.5	24.36	57.81

Distributed loads (Polygon):

Load No. (1):

Corner	lNo.	Load value	X-coord.	Y-coord.
I	P	x	y	
[-]	[kN/m2]	[m]	[m]	
1	6	1.5	44.5	
2	6	9.5	41.5	
3	6	9.5	1.5	
4	6.000002	1.5	1.5	

Load No. (2):

Corner	lNo.	Load value	X-coord.	Y-coord.
I	P	x	y	
[-]	[kN/m2]	[m]	[m]	
1	6	9.5	41.5	
2	6	24.36	57.71	
3	6	18.46	63.11	
4	6	1.5	44.5	

Tarut Bridge - Analysis and design of foundation

Loads

Loading data:

Distribute column loads: (Yes)

Slab weight	Pe [kN]	= 29986.2
Force on slab	Pa [kN]	= 72196.9
Groundwater force	Pw [kN]	= 0.0
Total load ($P = Pe + Pa - Pw$)	P [kN]	= 102183.1
Groundwater pressure on raft	Qw [kN/m ²]	= 0.0
Average contact pressure	Qo [kN/m ²]	= 136.3

Sum Mx from loads	Mx [kN.m]	= -3775.3
Sum My from loads	My [kN.m]	= 14601.9

Eccentricity of loading in x-direction	ex [cm]	= 14.29
Eccentricity of loading in y-direction	ey [cm]	= -3.69

Moment of inertia of slab about x-Axis	Ix [m ⁴]	= 247347.59
Moment of inertia of slab about y-Axis	Iy [m ⁴]	= 26234.73
Product of inertia	Ixy [m ⁴]	= 50664.27
Area of the slab	A [m ²]	= 749.65
Volume of the slab	V [m ³]	= 1199.45

GEOTEC

PO Box 14001 Richmond Road PO, Calgary AB, Canada T3E 7Y7

Data of piles

Title: Pile foundation analysis of the tunnel-right side

Tarut Bridge - Analysis and design of foundation

Date: 25/09/2010
 Project: Tarut bridge, Qatif city- Saudi Arabia
 File: Tunnel floor analysis

Analysis of slab foundation
 by the program package ELPLA
 Version 9.2 SP1

Calculation method:
 Method (9) (Layered soil model)
 Rigid free-standing raft

File groups:

Group No.: 1
 Description of pile groups: P1
 Pile diameter D [m] = 1.2
 Pile toe diameter Df [m] = 1.2
 Pile length Lg [m] = 28

Soil data under the pile tip:
 Pile tip resistance (s/Df = 0.02) Sig [kN/m2] = 800
 Pile tip resistance (s/Df = 0.03) Sig1 [kN/m2] = 1100
 Pile tip resistance (s/Df = 0.1) SigGR [kN/m2] = 2442

Geotechnical data of the layer:

Layer No.	Layer thickness L1 [m]	Undrainage cohesion Cu [kN/m2]	Penetration resistance qs [kN/m2]	Skin friction Tau [kN/m2]
1	5.50	-	-	0
2	4.50	-	-	35
3	18.00	-	-	100

Pile locations and groups:

File No.	Node No.	X-coord. [m]	Y-coord. [m]	Group No.
1	139	1.50	1.50	1
2	147	9.50	1.50	1
3	143	5.50	1.50	1
4	166	1.50	4.50	1
5	193	1.50	7.50	1
6	197	5.50	7.50	1
7	170	5.50	4.50	1
8	174	9.50	4.50	1
9	201	9.50	7.50	1
10	229	1.50	11.50	1
11	233	5.50	11.50	1
12	237	9.50	11.50	1
13	265	1.50	15.50	1
14	269	5.50	15.50	1
15	273	9.50	15.50	1
16	301	1.50	19.50	1

Continue of table at next page

GEOTEC
 PO Box 14001 Richmond Road PO, Calgary AB, Canada T3E 7Y7

Data of piles

Continue of table

Tarut Bridge - Analysis and design of foundation

Pile No. [-]	Node No. [-]	X-coord. [m]	Y-coord. [m]	Group No. [-]
17	305	5.50	19.50	1
18	309	9.50	19.50	1
19	337	1.50	23.50	1
20	341	5.50	23.50	1
21	345	9.50	23.50	1
22	373	1.50	27.50	1
23	377	5.50	27.50	1
24	381	9.50	27.50	1
25	409	1.50	31.50	1
26	413	5.50	31.50	1
27	417	9.50	31.50	1
28	445	1.50	35.50	1
29	449	5.50	35.50	1
30	453	9.50	35.50	1
31	481	1.50	39.50	1
32	485	5.50	39.50	1
33	489	9.50	39.50	1
34	507	9.50	41.50	1
35	532	1.50	44.50	1
36	537	6.42	44.50	1
37	560	3.60	47.14	1
38	587	6.42	50.00	1
39	629	9.50	53.00	1
40	657	11.95	55.75	1
41	700	14.65	58.50	1
42	722	16.43	60.75	1
43	735	18.46	63.11	1
44	727	21.41	60.75	1
45	705	19.38	58.50	1
46	663	17.60	55.75	1
47	634	14.65	53.00	1
48	592	11.95	50.00	1
49	566	9.50	47.14	1
50	542	11.95	44.50	1
51	571	14.65	47.14	1
52	598	17.60	50.00	1
53	640	20.30	53.00	1
54	668	22.33	55.75	1
55	696	24.36	57.71	1

File material:

Modulus of elasticity of pile Ep [kN/m²] = 24000000.00
 Unit weight of pile concrete GP [kN/m³] = 25.50
 (including 0.5 pile length above see bed)

GEOTEC

PO Box 14001 Richmond Road PO, Calgary AB, Canada T3E 7Y7

Support reactions

Title: Pile foundation analysis of the tunnel-right side
 Date: 25/09/2010
 Project: Tarut bridge, Qatif city- Saudi Arabia

Tarut Bridge - Analysis and design of foundation

File: Tunnel floor analysis

Analysis of slab foundation
by the program package ELPLA
Version 9.2 SP1

Calculation method:
Method (9) (Layered soil model)
Rigid free-standing raft

Support reactions

Node No.	Load-V	Moment-Y	Moment-X
I	V	My	Mx
[-]	[kN]	[kN.m]	[kN.m]
139	2706.3	0.0	0.0
143	2216.7	0.0	0.0
147	2282.6	0.0	0.0
166	2252.2	0.0	0.0
170	1775.3	0.0	0.0
174	1871.0	0.0	0.0
193	2098.2	0.0	0.0
197	1634.2	0.0	0.0
201	1725.5	0.0	0.0
229	2040.5	0.0	0.0
233	1588.5	0.0	0.0
237	1664.8	0.0	0.0
265	2006.2	0.0	0.0
269	1562.1	0.0	0.0
273	1628.4	0.0	0.0
301	1993.3	0.0	0.0
305	1550.5	0.0	0.0
309	1609.4	0.0	0.0
337	1996.1	0.0	0.0
341	1548.9	0.0	0.0
345	1600.1	0.0	0.0
373	2012.4	0.0	0.0
377	1554.4	0.0	0.0
381	1594.3	0.0	0.0
409	2045.2	0.0	0.0
413	1565.9	0.0	0.0
417	1586.1	0.0	0.0
445	2108.0	0.0	0.0
449	1587.4	0.0	0.0
453	1565.2	0.0	0.0
481	2245.5	0.0	0.0
485	1643.1	0.0	0.0
489	1487.0	0.0	0.0
507	1474.7	0.0	0.0
532	2531.3	0.0	0.0
537	1699.9	0.0	0.0
542	1532.4	0.0	0.0
560	2293.2	0.0	0.0
566	1574.3	0.0	0.0
571	1583.7	0.0	0.0
587	2138.7	0.0	0.0

Continue of table at next page

GEOTEC
PO Box 14001 Richmond Road PO, Calgary AB, Canada T3E 7Y7

Support reactions

Continue of table

Node No.	Load-V	Moment-Y	Moment-X
----------	--------	----------	----------

Tarut Bridge - Analysis and design of foundation

I	V	My	Mx
[-]	[kN]	[kN.m]	[kN.m]
592	1566.8	0.0	0.0
598	1653.1	0.0	0.0
629	2025.6	0.0	0.0
634	1585.2	0.0	0.0
640	1717.3	0.0	0.0
657	2024.7	0.0	0.0
663	1611.1	0.0	0.0
668	1837.2	0.0	0.0
696	2206.1	0.0	0.0
700	2026.3	0.0	0.0
705	1767.0	0.0	0.0
722	2181.4	0.0	0.0
727	2191.4	0.0	0.0
735	2616.5	0.0	0.0

Sum. V 102183.1

GEOTEC Office Output Sample

GEOTEC
PO Box 14001 Richmond Road PO, Calgary AB, Canada T3E 7Y7

File results

Title: Pile foundation analysis of the tunnel-right side
Date: 25/09/2010
Project: Tarut bridge, Qatif city- Saudi Arabia
File: Tunnel floor analysis

Tarut Bridge - Analysis and design of foundation

Analysis of slab foundation
by the program package ELPLA
Version 9.2 SP1

Calculation method:
Method (9) (Layered soil model)
Rigid free-standing raft

File results

Value of total load (including own wt.)		Po	[kN] = 102183.1
Total pile loads		PL	[kN] = 102183.1
Bearing factor of piled raft		Alfa-Kpp	[%] = 100.00

File loads and displacements

File No.	pile load	Settlement	Soil stiffness
I	Fr	Sr	ks
[-]	[kN]	[cm]	[kN/m]
1	2706.3	1.63	165892.1
2	2282.6	1.72	132926.5
3	2216.7	1.70	130067.7
4	2252.2	1.66	136032.1
5	2098.2	1.76	119370.3
6	1634.2	1.89	86285.8
7	1775.3	1.82	97494.8
8	1871.0	2.06	90634.9
9	1725.5	1.90	90632.4
10	2040.5	1.85	110451.2
11	1588.5	1.92	82593.4
12	1664.8	1.70	98001.1
13	2006.2	1.94	103266.4
14	1562.1	1.77	88010.4
15	1628.4	1.74	93470.4
16	1993.3	1.85	107686.8
17	1550.5	1.82	85273.5
18	1609.4	1.79	90140.5
19	1996.1	1.72	116172.1
20	1548.9	1.86	83290.1
21	1600.1	1.83	87421.6
22	2012.4	1.76	114240.4
23	1554.4	1.90	81596.8
24	1594.3	1.87	85159.4
25	2045.2	1.80	113314.5
26	1565.9	1.95	80376.9
27	1586.1	1.92	82803.2
28	2108.0	1.85	113959.6
29	1587.4	1.82	87439.5
30	1565.2	1.96	79983.7
31	2245.5	1.89	118711.1
32	1643.1	1.86	88396.6
33	1487.0	1.86	79771.2
34	1474.7	1.87	78700.1
35	2531.3	1.90	133002.5

Continue of table at next page

GEOTEC
PO Box 14001 Richmond Road PO, Calgary AB, Canada T3E 7Y7

File results

Continue of table

File No.	pile load	Settlement	Soil stiffness
I	Fr	Sr	ks
[-]	[kN]	[cm]	[kN/m]

Tarut Bridge - Analysis and design of foundation

36	1699.9	1.93	87968.0
37	2293.2	2.00	114536.1
38	2138.7	1.98	108088.8
39	2025.6	1.94	104536.1
40	2024.7	1.85	109486.8
41	2026.3	1.76	114869.2
42	2181.4	1.72	126734.3
43	2616.5	1.66	158039.0
44	2191.4	1.82	120133.7
45	1767.0	1.76	100645.1
46	1611.1	1.82	88719.6
47	1585.2	1.83	86543.4
48	1566.8	1.95	80307.5
49	1574.3	2.03	77442.5
50	1532.4	1.85	82984.1
51	1583.7	1.79	88420.5
52	1653.1	1.92	85885.3
53	1717.3	1.87	91981.9
54	1837.2	1.83	100638.8
55	2206.1	1.78	124073.1

File loads

File No.	Skin resistance Qma [kN]	Tip resistance Qsp [kN]	Total load Fr [kN]
1	2317.3	337.4	2706.3
2	1947.3	283.5	2282.6
3	1913.4	278.6	2216.7
4	1952.5	284.3	2252.2
5	1823.9	265.5	2098.2
6	1453.3	211.6	1634.2
7	1568.0	228.3	1775.3
8	1624.0	236.4	1871.0
9	1506.6	219.4	1725.5
10	1770.5	257.8	2040.5
11	1411.9	205.6	1588.5
12	1454.4	211.8	1664.8
13	1739.1	253.2	2006.2
14	1387.9	202.1	1562.1
15	1423.3	207.2	1628.4
16	1726.6	251.4	1993.3
17	1377.3	200.5	1550.5
18	1407.4	204.9	1609.4
19	1728.2	251.6	1996.1
20	1376.0	200.3	1548.9
21	1400.3	203.9	1600.1
22	1741.9	253.6	2012.4
23	1381.3	201.1	1554.4
24	1397.1	203.4	1594.3
25	1769.8	257.7	2045.2
26	1392.5	202.7	1565.9
27	1393.0	202.8	1586.1
28	1822.6	265.4	2108.0

Continue of table at next page

GEOTEC
PO Box 14001 Richmond Road PO, Calgary AB, Canada T3E 7Y7

File results

Continue of table

File No.	Skin resistance Qma [kN]	Tip resistance Qsp [kN]	Total load Fr [kN]
----------	--------------------------------	-------------------------------	--------------------------

Tarut Bridge - Analysis and design of foundation

30	1380.2	201.0	1565.2
31	1934.5	281.7	2245.5
32	1459.3	212.5	1643.1
33	1324.9	192.9	1487.0
34	1318.4	192.0	1474.7
35	2166.6	315.4	2531.3
36	1507.4	219.5	1699.9
37	1977.8	288.0	2293.2
38	1850.4	269.4	2138.7
39	1758.7	256.1	2025.6
40	1758.3	256.0	2024.7
41	1763.3	256.7	2026.3
42	1888.9	275.0	2181.4
43	2234.4	325.3	2616.5
44	1885.1	274.5	2191.4
45	1556.9	226.7	1767.0
46	1431.7	208.4	1611.1
47	1410.3	205.3	1585.2
48	1396.4	203.3	1566.8
49	1404.3	204.5	1574.3
50	1358.9	197.8	1532.4
51	1394.7	203.1	1583.7
52	1446.2	210.6	1653.1
53	1497.0	218.0	1717.3
54	1593.7	232.0	1837.2
55	1878.2	273.5	2206.1

 File settlements

File No.	Self settlement I Sv [-] [cm]	Settlement Sr-Sv [cm]	Sum of settlements Sr [cm]
1	0.94	0.70	1.63
2	0.79	0.93	1.72
3	0.77	0.93	1.70
4	0.79	0.87	1.66
5	0.74	1.02	1.76
6	0.59	1.31	1.89
7	0.63	1.19	1.82
8	0.66	1.41	2.06
9	0.61	1.30	1.90
10	0.71	1.13	1.85
11	0.57	1.35	1.92
12	0.59	1.11	1.70
13	0.70	1.24	1.94
14	0.56	1.21	1.77
15	0.57	1.17	1.74
16	0.70	1.15	1.85
17	0.56	1.26	1.82
18	0.57	1.22	1.79
19	0.70	1.02	1.72
20	0.56	1.30	1.86
21	0.57	1.26	1.83
22	0.70	1.06	1.76

Continue of table at next page

GEOTEC

PO Box 14001 Richmond Road PO, Calgary AB, Canada T3E 7Y7

 File results

Continue of table

File No.	Self settlement I Sv [-] [cm]	Settlement Sr-Sv [cm]	Sum of settlements Sr [cm]
23	0.56	1.35	1.90

Tarut Bridge - Analysis and design of foundation

24	0.56	1.31	1.87
25	0.71	1.09	1.80
26	0.56	1.39	1.95
27	0.56	1.35	1.92
28	0.74	1.11	1.85
29	0.57	1.25	1.82
30	0.56	1.40	1.96
31	0.78	1.11	1.89
32	0.59	1.27	1.86
33	0.54	1.33	1.86
34	0.53	1.34	1.87
35	0.87	1.03	1.90
36	0.61	1.32	1.93
37	0.80	1.20	2.00
38	0.75	1.23	1.98
39	0.71	1.23	1.94
40	0.71	1.14	1.85
41	0.71	1.05	1.76
42	0.76	0.96	1.72
43	0.90	0.75	1.66
44	0.76	1.06	1.82
45	0.63	1.13	1.76
46	0.58	1.24	1.82
47	0.57	1.26	1.83
48	0.56	1.39	1.95
49	0.57	1.47	2.03
50	0.55	1.30	1.85
51	0.56	1.23	1.79
52	0.58	1.34	1.92
53	0.60	1.26	1.87
54	0.64	1.18	1.83
55	0.76	1.02	1.78

Tarut Bridge - Analysis and design of foundation

Method (9) (Layered soil model)
Rigid free-standing raft

$y = 26.62$ [m]

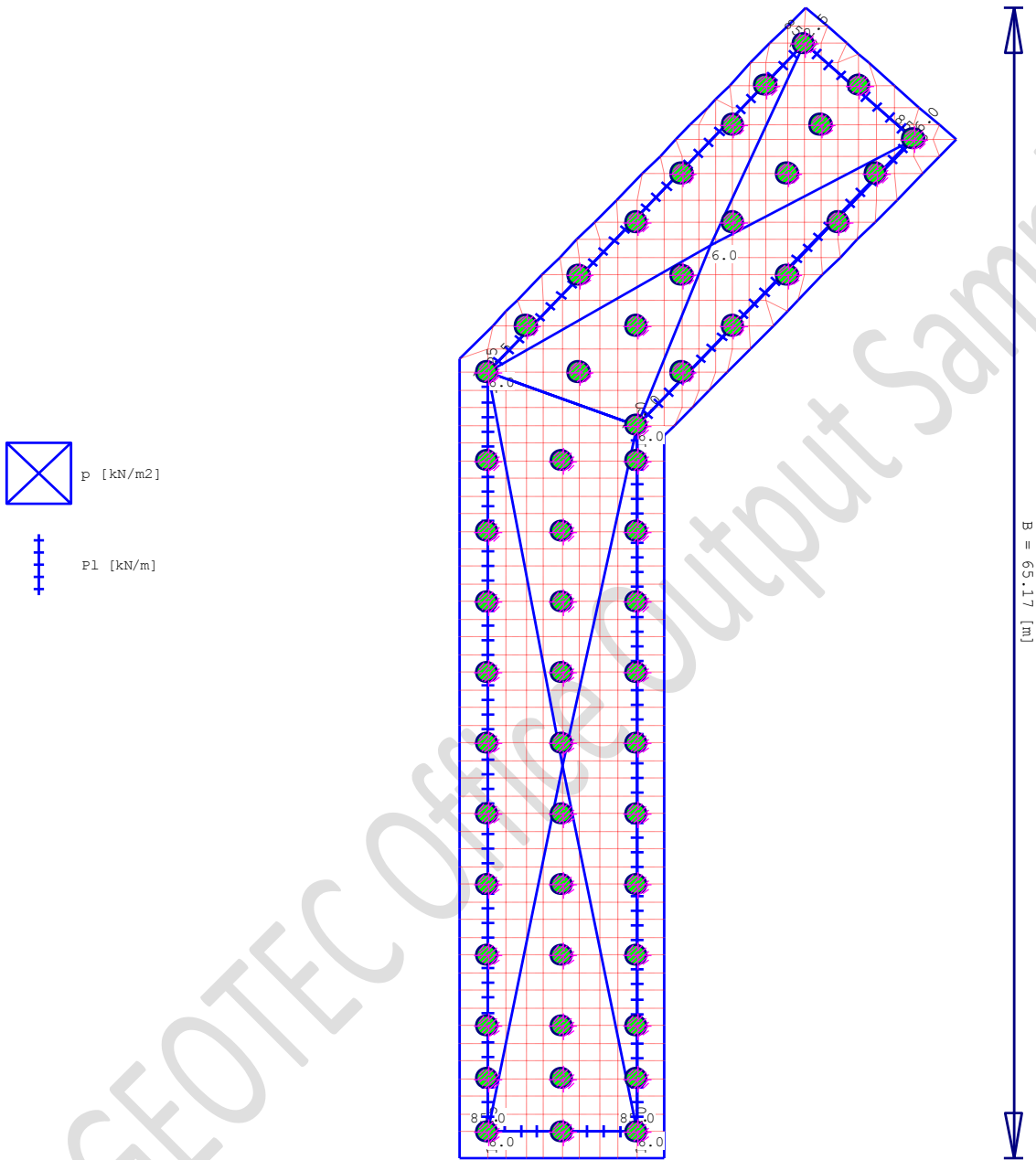

Loads

GEOTEC Software

P. O. Box 465, Port-Said, Egypt* Tel. +2066-3609247

Scale 1:345

File: Tunnel floor analysis

Page No. :

Title: Pile foundation analysis of the tunnel-right side

Date: 25/09/2010

Project: Tarut bridge, Qatif city- Saudi Arabia

Tarut Bridge - Analysis and design of foundation

Method (9) (Layered soil model)
Rigid free-standing raft

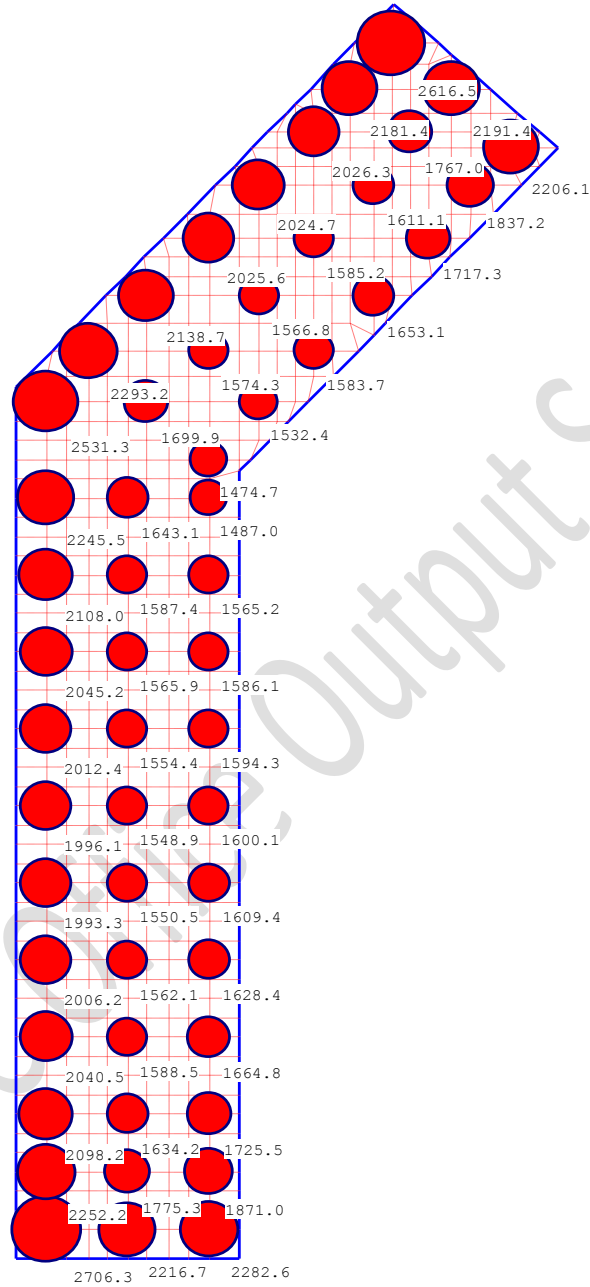

Support reactions V [kN]
Max. V = 2706.3 at node 139, Min. V = 1474.7 at node 507, Sum = 102183.1

GEOTEC Software
P. O. Box 465, Port-Said, Egypt* Tel. +2066-3609247

Scale 1:345	Title: Pile foundation analysis of the tunnel-right side
File: Tunnel floor analysis	Date: 25/09/2010
Page No. :	Project: Tarut bridge, Qatif city- Saudi Arabia

Method (9) (Layered soil model)
Rigid free-standing raft

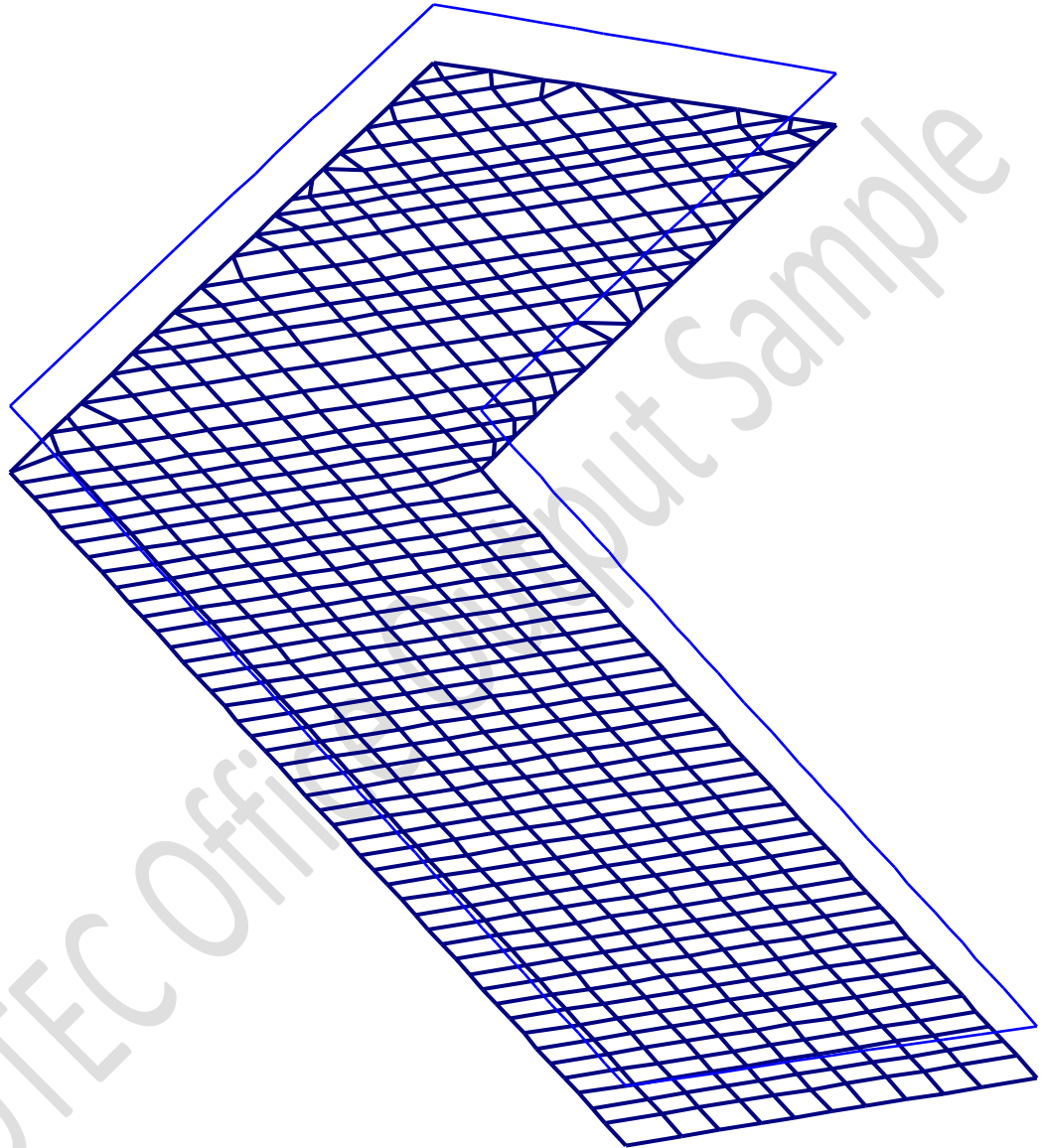

Slab deformation w [cm]
Max. $w = 2.08$ at node 6, Min. $w = 1.63$ at node 4

GEOTEC Software

P. O. Box 465, Port-Said, Egypt* Tel. +2066-3609247

Scale factor: 175

File: Tunnel floor analysis

Page No.:

Title: Pile foundation analysis of the tunnel-right side

Date: 25/09/2010

Project: Tarut bridge, Qatif city- Saudi Arabia

16 Tunnel floor design – Right side

```
*****
                          Analysis of slab foundation
                          by the program package ELPLA
                          Version 9.2 SP1
*****
```

Title: Pile foundation design of the tunnel-right side
Date: 25/09/2010
Project: Tarut bridge, Qatif city- Saudi Arabia
File: Tunnel floor design

Calculation method:
Method (3)
Modulus of subgrade reaction is defined by the user

Program authors Prof. M. El Gendy/ Dr. A. El Gendy
GEOTEC Software Inc. PO Box 14001 Richmond Road PO, Calgary AB, Canada T3E 7Y7
www.geotecsoftware.com; geotec@geotecsoftware.com ; Tele.:+1(587) 332-3323

Tarut Bridge - Analysis and design of foundation

PO Box 14001 Richmond Road PO, Calgary AB, Canada T3E 7Y7

Slab properties/ Foundation level/ Global coordinates

Title: Pile foundation design of the tunnel-right side

Date: 25/09/2010

Project: Tarut bridge, Qatif city- Saudi Arabia

File: Tunnel floor design

Analysis of slab foundation
by the program package ELPLA
Version 9.2 SP1

Calculation method:

Method (3)

Modulus of subgrade reaction is defined by the user

Slab properties/ Foundation level/ Global coordinates

Unit weight of slab material GB [kN/m3] = 25.0

Element groups (with the same thickness and material):

Group No.	E-Modulus of slab Ep [kN/m2]	Poisson's ratio Nue [-]	Slab thickness d [m]
1	2.4E+07	0.2	1.6

GEOTEC

PO Box 14001 Richmond Road PO, Calgary AB, Canada T3E 7Y7

Tarut Bridge - Analysis and design of foundation

L o a d s

Title: Pile foundation design of the tunnel-right side
 Date: 25/09/2010
 Project: Tarut bridge, Qatif city- Saudi Arabia
 File: Tunnel floor design

Analysis of slab foundation
 by the program package ELPLA
 Version 9.2 SP1

Calculation method:
 Method (3)
 Modulus of subgrade reaction is defined by the user

L o a d i n g

Line loads:

Load No.	Load start value	Load end value	Load start	Load start	Load end	Load end
I	P1	P1	x1	y1	x2	y2
[-]	[kN/m]	[kN/m]	[m]	[m]	[m]	[m]
1	85	85	1.5	1.5	9.5	1.5
2	85	85	18.46	63.11	24.36	57.71
3	172.5	172.5	1.5	1.5	1.5	44.5
4	172.5	172.5	1.5	44.5	18.46	63.11
5	186	186	9.5	1.5	9.5	41.5
6	186	186	9.5	41.5	24.36	57.81

Distributed loads (Polygon):

Load No. (1):

Corner	lNo.	Load value	X-coord.	Y-coord.
I	P	x	y	
[-]	[kN/m2]	[m]	[m]	
1	6	1.5	44.5	
2	6	9.5	41.5	
3	6	9.5	1.5	
4	6.000002	1.5	1.5	

Load No. (2):

Corner	lNo.	Load value	X-coord.	Y-coord.
I	P	x	y	
[-]	[kN/m2]	[m]	[m]	
1	6	9.5	41.5	
2	6	24.36	57.71	
3	6	18.46	63.11	
4	6	1.5	44.5	

Tarut Bridge - Analysis and design of foundation

Loads

Loading data:

Distribute column loads: (Yes)

Slab weight	Pe [kN]	= 29986.2
Force on slab	Pa [kN]	= 72196.9
Groundwater force	Pw [kN]	= 0.0
Total load ($P = Pe + Pa - Pw$)	P [kN]	= 102183.1
Groundwater pressure on raft	Qw [kN/m ²]	= 0.0
Average contact pressure	Qo [kN/m ²]	= 136.3

Sum Mx from loads	Mx [kN.m]	= -3775.3
Sum My from loads	My [kN.m]	= 14601.9

Eccentricity of loading in x-direction	ex [cm]	= 14.29
Eccentricity of loading in y-direction	ey [cm]	= -3.69

Moment of inertia of slab about x-Axis	Ix [m ⁴]	= 247347.59
Moment of inertia of slab about y-Axis	Iy [m ⁴]	= 26234.73
Product of inertia	Ixy [m ⁴]	= 50664.27
Area of the slab	A [m ²]	= 749.65
Volume of the slab	V [m ³]	= 1199.45

GEOTEC

PO Box 14001 Richmond Road PO, Calgary AB, Canada T3E 7Y7

Data of reinforcement

Tarut Bridge - Analysis and design of foundation

Title: Pile foundation design of the tunnel-right side
Date: 25/09/2010
Project: Tarut bridge, Qatif city- Saudi Arabia
File: Tunnel floor design

Analysis of slab foundation
by the program package ELPLA
Version 9.2 SP1

Calculation method:
Method (3)
Modulus of subgrade reaction is defined by the user

Data of reinforcement (Design for flexural moment)

Design Code
Concrete grade C 300
Steel Grade S 36/52

Compressive strength f_c [kN/m²] = 10500
Tensile strength f_s [kN/m²] = 200000

Concrete cover+ 1/2 bar diameter
X-direction top d_{1x} [cm] = 7
X-direction bottom d_{2x} [cm] = 7
Y-direction top d_{1y} [cm] = 7
Y-direction bottom d_{2y} [cm] = 7

GEOTEC Office Output Sample

GEOTEC
PO Box 14001 Richmond Road PO, Calgary AB, Canada T3E 7Y7

Data of piles

Tarut Bridge - Analysis and design of foundation

Title: Pile foundation design of the tunnel-right side
 Date: 25/09/2010
 Project: Tarut bridge, Qatif city- Saudi Arabia
 File: Tunnel floor design

Analysis of slab foundation
 by the program package ELPLA
 Version 9.2 SP1

Calculation method:
 Method (3)
 Modulus of subgrade reaction is defined by the user

File groups:

Group No. I [-]	Pile diameter D [m]	Pile length L [m]	Pile stiffness kz [kN/m]
1	1.20	28.00	147082.0
2	1.20	28.00	125949.0
3	1.20	28.00	135869.0
4	1.20	28.00	121741.0
5	1.20	28.00	100299.0
6	1.20	28.00	110059.0
7	1.20	28.00	112203.0
8	1.20	28.00	91296.0
9	1.20	28.00	100906.0
10	1.20	28.00	107963.0
11	1.20	28.00	87762.0
12	1.20	28.00	96231.0
13	1.20	28.00	105590.0
14	1.20	28.00	85361.0
15	1.20	28.00	93051.0
16	1.20	28.00	103818.0
17	1.20	28.00	83811.0
18	1.20	28.00	90927.0
19	1.20	28.00	102892.0
20	1.20	28.00	82829.0
21	1.20	28.00	89391.0
22	1.20	28.00	102674.0
23	1.20	28.00	82243.0
24	1.20	28.00	88083.0
25	1.20	28.00	103293.0
26	1.20	28.00	81984.0
27	1.20	28.00	86672.0
28	1.20	28.00	105400.0
29	1.20	28.00	82249.0
30	1.20	28.00	84605.0
31	1.20	28.00	111163.0
32	1.20	28.00	84262.0
33	1.20	28.00	79519.0
34	1.20	28.00	123478.0
35	1.20	28.00	87174.0
36	1.20	28.00	78442.0
37	1.20	28.00	113525.0
38	1.20	28.00	82424.0
39	1.20	28.00	82832.0
40	1.20	28.00	108015.0

Continue of table at next page

GEOTEC
 PO Box 14001 Richmond Road PO, Calgary AB, Canada T3E 7Y7

Data of piles

Continue of table

Tarut Bridge - Analysis and design of foundation

Group No. I [-]	Pile diameter D [m]	Pile length L [m]	Pile stiffness kz [kN/m]
41	1.20	28.00	83786.0
42	1.20	28.00	87497.0
43	1.20	28.00	104953.0
44	1.20	28.00	86152.0
45	1.20	28.00	93396.0
46	1.20	28.00	106563.0
47	1.20	28.00	90006.0
48	1.20	28.00	99266.0
49	1.20	28.00	108941.0
50	1.20	28.00	99831.0
51	1.20	28.00	108071.0
52	1.20	28.00	118554.0
53	1.20	28.00	125223.0
54	1.20	28.00	132102.0
55	1.20	28.00	144558.0

File locations and groups:

Pile No. [-]	Node No. [-]	X-coord. [m]	Y-coord. [m]	Group No. [-]
1	139	1.50	1.50	1
2	147	9.50	1.50	3
3	143	5.50	1.50	2
4	166	1.50	4.50	4
5	170	5.50	4.50	5
6	174	9.50	4.50	6
7	193	1.50	7.50	7
8	197	5.50	7.50	8
9	201	9.50	7.50	9
10	229	1.50	11.50	10
11	233	5.50	11.50	11
12	237	9.50	11.50	12
13	265	1.50	15.50	13
14	269	5.50	15.50	14
15	273	9.50	15.50	15
16	301	1.50	19.50	16
17	305	5.50	19.50	17
18	309	9.50	19.50	18
19	337	1.50	23.50	19
20	341	5.50	23.50	20
21	345	9.50	23.50	21
22	373	1.50	27.50	22
23	377	5.50	27.50	23
24	381	9.50	27.50	24
25	409	1.50	31.50	25
26	413	5.50	31.50	26
27	417	9.50	31.50	27
28	445	1.50	35.50	28
29	449	5.50	35.50	29
30	453	9.50	35.50	30
31	481	1.50	39.50	31
32	485	5.50	39.50	32
33	489	9.50	39.50	33

Continue of table at next page

GEOTEC
PO Box 14001 Richmond Road PO, Calgary AB, Canada T3E 7Y7

Data of piles

Continue of table

Tarut Bridge - Analysis and design of foundation

File No. [-]	Node No. [-]	X-coord. [m]	Y-coord. [m]	Group No. [-]
34	532	1.50	44.50	34
35	537	6.42	44.50	35
36	542	11.95	44.50	39
37	587	6.42	50.00	40
38	566	9.50	47.14	38
39	560	3.60	47.14	37
40	507	9.50	41.50	36
41	592	11.95	50.00	41
42	571	14.65	47.14	42
43	629	9.50	53.00	43
44	634	14.65	53.00	44
45	598	17.60	50.00	45
46	657	11.95	55.75	46
47	663	17.60	55.75	47
48	640	20.30	53.00	48
49	700	14.65	58.50	49
50	705	19.38	58.50	50
51	668	22.33	55.75	51
52	722	16.43	60.75	52
53	727	21.41	60.75	53
54	696	24.36	57.71	54
55	735	18.46	63.11	55

File material:

Modulus of elasticity of pile Ep [kN/m²] = 24000000.00
 Unit weight of pile concrete GP [kN/m³] = 25.50
 (Including 1 m pile length above the sea bed)

GEOTEC
 PO Box 14001 Richmond Road PO, Calgary AB, Canada T3E 7Y7

 Support reactions

Title: Pile foundation design of the tunnel-right side
 Date: 25/09/2010
 Project: Tarut bridge, Qatif city- Saudi Arabia

Tarut Bridge - Analysis and design of foundation

File: Tunnel floor design

Analysis of slab foundation
by the program package ELPLA
Version 9.2 SP1

Calculation method:

Method (3)

Modulus of subgrade reaction is defined by the user

Support reactions

Node No.	Load-V	Moment-Y	Moment-X
I	V	My	Mx
[-]	[kN]	[kN.m]	[kN.m]
139	1776.4	0.0	0.0
143	1662.6	0.0	0.0
147	1944.9	0.0	0.0
166	1696.2	0.0	0.0
170	1511.1	0.0	0.0
174	1790.2	0.0	0.0
193	1755.7	0.0	0.0
197	1534.9	0.0	0.0
201	1826.9	0.0	0.0
229	1889.6	0.0	0.0
233	1644.8	0.0	0.0
237	1939.1	0.0	0.0
265	1980.3	0.0	0.0
269	1714.8	0.0	0.0
273	2009.7	0.0	0.0
301	2022.9	0.0	0.0
305	1753.5	0.0	0.0
309	2047.5	0.0	0.0
337	2041.4	0.0	0.0
341	1770.4	0.0	0.0
345	2060.6	0.0	0.0
373	2047.9	0.0	0.0
377	1773.5	0.0	0.0
381	2053.8	0.0	0.0
409	2053.0	0.0	0.0
413	1767.5	0.0	0.0
417	2025.7	0.0	0.0
445	2070.4	0.0	0.0
449	1756.6	0.0	0.0
453	1962.4	0.0	0.0
481	2136.7	0.0	0.0
485	1762.6	0.0	0.0
489	1805.1	0.0	0.0
507	1750.2	0.0	0.0
532	2259.8	0.0	0.0
537	1771.8	0.0	0.0
542	1859.3	0.0	0.0
560	2107.6	0.0	0.0
566	1706.9	0.0	0.0
571	1939.8	0.0	0.0
587	2037.7	0.0	0.0

Continue of table at next page

GEOTEC

PO Box 14001 Richmond Road PO, Calgary AB, Canada T3E 7Y7

Support reactions

Continue of table

Node No.	Load-V	Moment-Y	Moment-X
----------	--------	----------	----------

Tarut Bridge - Analysis and design of foundation

I	V	My	Mx
[-]	[kN]	[kN.m]	[kN.m]
592	1698.9	0.0	0.0
598	1968.7	0.0	0.0
629	1952.0	0.0	0.0
634	1649.6	0.0	0.0
640	1896.1	0.0	0.0
657	1874.5	0.0	0.0
663	1567.1	0.0	0.0
668	1823.1	0.0	0.0
696	1989.6	0.0	0.0
700	1733.6	0.0	0.0
705	1527.4	0.0	0.0
722	1681.9	0.0	0.0
727	1671.0	0.0	0.0
735	1758.4	0.0	0.0

Sum. V 101813.8

GEOTEC Office Output Sample

GEOTEC

PO Box 14001 Richmond Road PO, Calgary AB, Canada T3E 7Y7

File results

Title: Pile foundation design of the tunnel-right side
Date: 25/09/2010
Project: Tarut bridge, Qatif city- Saudi Arabia
File: Tunnel floor design

Tarut Bridge - Analysis and design of foundation

Analysis of slab foundation
by the program package ELPLA
Version 9.2 SP1

Calculation method:

Method (3)

Modulus of subgrade reaction is defined by the user

File results

Value of total load (including own wt.)		Po	[kN] = 102183.1
Total pile loads		PL	[kN] = 101813.8
Bearing factor of piled raft		Alfa-Kpp	[%] = 99.64

File loads and displacements

File No. I [-]	pile load Fr [kN]	Settlement Sr [cm]	Soil stiffness ks [kN/m]
1	1776.4	1.21	147082.0
2	1944.9	1.43	135869.0
3	1662.6	1.32	125949.0
4	1696.2	1.39	121741.0
5	1511.1	1.51	100299.0
6	1790.2	1.63	110059.0
7	1755.7	1.56	112203.0
8	1534.9	1.68	91296.0
9	1826.9	1.81	100906.0
10	1889.6	1.75	107963.0
11	1644.8	1.87	87762.0
12	1939.1	2.02	96231.0
13	1980.3	1.88	105590.0
14	1714.8	2.01	85361.0
15	2009.7	2.16	93051.0
16	2022.9	1.95	103818.0
17	1753.5	2.09	83811.0
18	2047.5	2.25	90927.0
19	2041.4	1.98	102892.0
20	1770.4	2.14	82829.0
21	2060.6	2.31	89391.0
22	2047.9	1.99	102674.0
23	1773.5	2.16	82243.0
24	2053.8	2.33	88083.0
25	2053.0	1.99	103293.0
26	1767.5	2.16	81984.0
27	2025.7	2.34	86672.0
28	2070.4	1.96	105400.0
29	1756.6	2.14	82249.0
30	1962.4	2.32	84605.0
31	2136.7	1.92	111163.0
32	1762.6	2.09	84262.0
33	1805.1	2.27	79519.0
34	2259.8	1.83	123478.0
35	1771.8	2.03	87174.0

Continue of table at next page

GEOTEC

PO Box 14001 Richmond Road PO, Calgary AB, Canada T3E 7Y7

File results

Continue of table

File No. I [-]	pile load Fr [kN]	Settlement Sr [cm]	Soil stiffness ks [kN/m]
-------------------------	----------------------------	--------------------------	-----------------------------------

Tarut Bridge - Analysis and design of foundation

36	1859.3	2.24	82832.0
37	2037.7	1.89	108015.0
38	1706.9	2.07	82424.0
39	2107.6	1.86	113525.0
40	1750.2	2.23	78442.0
41	1698.9	2.03	83786.0
42	1939.8	2.22	87497.0
43	1952.0	1.86	104953.0
44	1649.6	1.91	86152.0
45	1968.7	2.11	93396.0
46	1874.5	1.76	106563.0
47	1567.1	1.74	90006.0
48	1896.1	1.91	99266.0
49	1733.6	1.59	108941.0
50	1527.4	1.53	99831.0
51	1823.1	1.69	108071.0
52	1681.9	1.42	118554.0
53	1671.0	1.33	125223.0
54	1989.6	1.51	132102.0
55	1758.4	1.22	144558.0

GEOTEC Office Output Sample

Tarut Bridge - Analysis and design of foundation

Punching Shear

Node No.	Load value	X-coord.	Y-coord.	Pile diameter	Punching shear stress	Stress on the column	Area of critical section of punching shear	Perimeter of critical section of punching shear	Effective depth of the section of punching shear	Punching shear stress ratio
I [-]	Pc [kN]	Xc [m]	Yc [m]	a [m]	Qp [kN/m ²]	Qo [kN/m ²]	PA [m ²]	AL [m]	Dp [m]	Rpa [%]
1	1776.4	1.5	1.5	1.2	118.1	41.5	5.7	8.52	1.53	4.23
2	1944.9	9.5	1.5	1.2	131	41.5	5.7	8.52	1.53	3.82
3	1662.6	5.5	1.5	1.2	108.7	43	5.7	8.52	1.53	4.6
4	1696.2	1.5	4.5	1.2	111.3	43	5.7	8.52	1.53	4.49
5	1511.1	5.5	4.5	1.2	95.8	46	5.7	8.52	1.53	5.22
6	1790.2	9.5	4.5	1.2	118.5	43	5.7	8.52	1.53	4.22
7	1755.7	1.5	7.5	1.2	115.8	43	5.7	8.52	1.53	4.32
8	1534.9	5.5	7.5	1.2	97.6	46	5.7	8.52	1.53	5.12
9	1826.9	9.5	7.5	1.2	121.3	43	5.7	8.52	1.53	4.12
10	1889.6	1.5	11.5	1.2	126.1	43	5.7	8.52	1.53	3.96
11	1644.8	5.5	11.5	1.2	106	46	5.7	8.52	1.53	4.72
12	1939.1	9.5	11.5	1.2	129.9	43	5.7	8.52	1.53	3.85
13	1980.3	1.5	15.5	1.2	133.1	43	5.7	8.52	1.53	3.76
14	1714.8	5.5	15.5	1.2	111.4	46	5.7	8.52	1.53	4.49
15	2009.7	9.5	15.5	1.2	135.3	43	5.7	8.52	1.53	3.69
16	2022.9	1.5	19.5	1.2	136.3	43	5.7	8.52	1.53	3.67
17	1753.5	5.5	19.5	1.2	114.4	46	5.7	8.52	1.53	4.37
18	2047.5	9.5	19.5	1.2	138.2	43	5.7	8.52	1.53	3.62
19	2041.4	1.5	23.5	1.2	137.8	43	5.7	8.52	1.53	3.63
20	1770.4	5.5	23.5	1.2	115.7	46	5.7	8.52	1.53	4.32

Tarut Bridge - Analysis and design of foundation

Node No.	Load value	X-coord.	Y-coord.	Pile diameter	Punching shear stress	Stress on the column	Area of critical section of punching shear	Perimeter of critical section of punching shear	Effective depth of the section of punching shear	Punching shear stress ratio
I [-]	Pc [kN]	Xc [m]	Yc [m]	a [m]	Qp [kN/m ²]	Qo [kN/m ²]	PA [m ²]	AL [m]	Dp [m]	Rpa [%]
21	2060.6	9.5	23.5	1.2	139.2	43	5.7	8.52	1.53	3.59
22	2047.9	1.5	27.5	1.2	138.3	43	5.7	8.52	1.53	3.62
23	1773.5	5.5	27.5	1.2	115.9	46	5.7	8.52	1.53	4.31
24	2053.8	9.5	27.5	1.2	138.7	43	5.7	8.52	1.53	3.6
25	2053	1.5	31.5	1.2	138.6	43	5.7	8.52	1.53	3.61
26	1767.5	5.5	31.5	1.2	115.4	46	5.7	8.52	1.53	4.33
27	2025.7	9.5	31.5	1.2	136.6	43	5.7	8.52	1.53	3.66
28	2070.4	1.5	35.5	1.2	140	43	5.7	8.52	1.53	3.57
29	1756.6	5.5	35.5	1.2	114.6	46	5.7	8.52	1.53	4.36
30	1962.4	9.5	35.5	1.2	131.7	43	5.7	8.52	1.53	3.8
31	2136.7	1.5	39.5	1.2	145.1	43	5.7	8.52	1.53	3.45
32	1762.6	5.5	39.5	1.2	115.1	46	5.7	8.52	1.53	4.35
33	1805.1	9.5	39.5	1.2	119.6	43	5.7	8.52	1.53	4.18
34	2259.8	1.5	44.5	1.2	155.7	40.2	5.7	8.52	1.53	3.21
35	1771.8	6.42	44.5	1.2	116	45.5	5.7	8.52	1.53	4.31
36	1859.3	11.95	44.5	1.2	124.3	41.8	5.7	8.53	1.53	4.02
37	2037.7	6.42	50	1.2	138.7	40.3	5.7	8.52	1.53	3.61
38	1706.9	9.5	47.14	1.2	110.8	46	5.7	8.52	1.53	4.51
39	2107.6	3.6	47.14	1.2	148.9	40.3	5.7	8.24	1.53	3.36
40	1750.2	9.5	41.5	1.2	116	41.7	5.7	8.52	1.53	4.31

Node	Load	X-coord.	Y-coord.	Pile	Punching	Stress	Area of	Perimeter	Effective	Punching
------	------	----------	----------	------	----------	--------	---------	-----------	-----------	----------

Tarut Bridge - Analysis and design of foundation

No.	value			diameter	shear stress	on the column	critical section of punching shear	of critical section of punching shear	depth of the section of punching shear	shear stress ratio
I [-]	Pc [kN]	Xc [m]	Yc [m]	a [m]	Qp [kN/m2]	Qo [kN/m2]	PA [m2]	AL [m]	Dp [m]	Rpa [%]
41	1698.9	11.95	50	1.2	110.1	46	5.7	8.53	1.53	4.54
42	1939.8	14.65	47.14	1.2	130.6	41.5	5.7	8.52	1.53	3.83
43	1952	9.5	53	1.2	131.5	41.7	5.7	8.52	1.53	3.8
44	1649.6	14.65	53	1.2	106.3	46	5.7	8.53	1.53	4.7
45	1968.7	17.6	50	1.2	133.4	40.3	5.7	8.52	1.53	3.75
46	1874.5	11.95	55.75	1.2	125.4	41.8	5.7	8.53	1.53	3.99
47	1567.1	17.6	55.75	1.2	100.1	46	5.7	8.52	1.53	5
48	1896.1	20.3	53	1.2	127.8	40.3	5.7	8.52	1.53	3.91
49	1733.6	14.65	58.5	1.2	114.5	42.3	5.7	8.52	1.53	4.37
50	1527.4	19.38	58.5	1.2	97	46	5.7	8.52	1.53	5.15
51	1823.1	22.33	55.75	1.2	121.6	41.7	5.7	8.52	1.53	4.11
52	1681.9	16.43	60.75	1.2	110.8	41.6	5.7	8.52	1.53	4.51
53	1671	21.41	60.75	1.2	120.5	40.2	5.68	7.82	1.53	4.15
54	1989.6	24.36	57.71	1.2	134.9	40.4	5.7	8.52	1.53	3.71
55	1758.4	18.46	63.11	1.2	122.9	40.3	5.69	8.13	1.53	4.07

Method (2)

Modulus of subgrade reaction is defined by the user

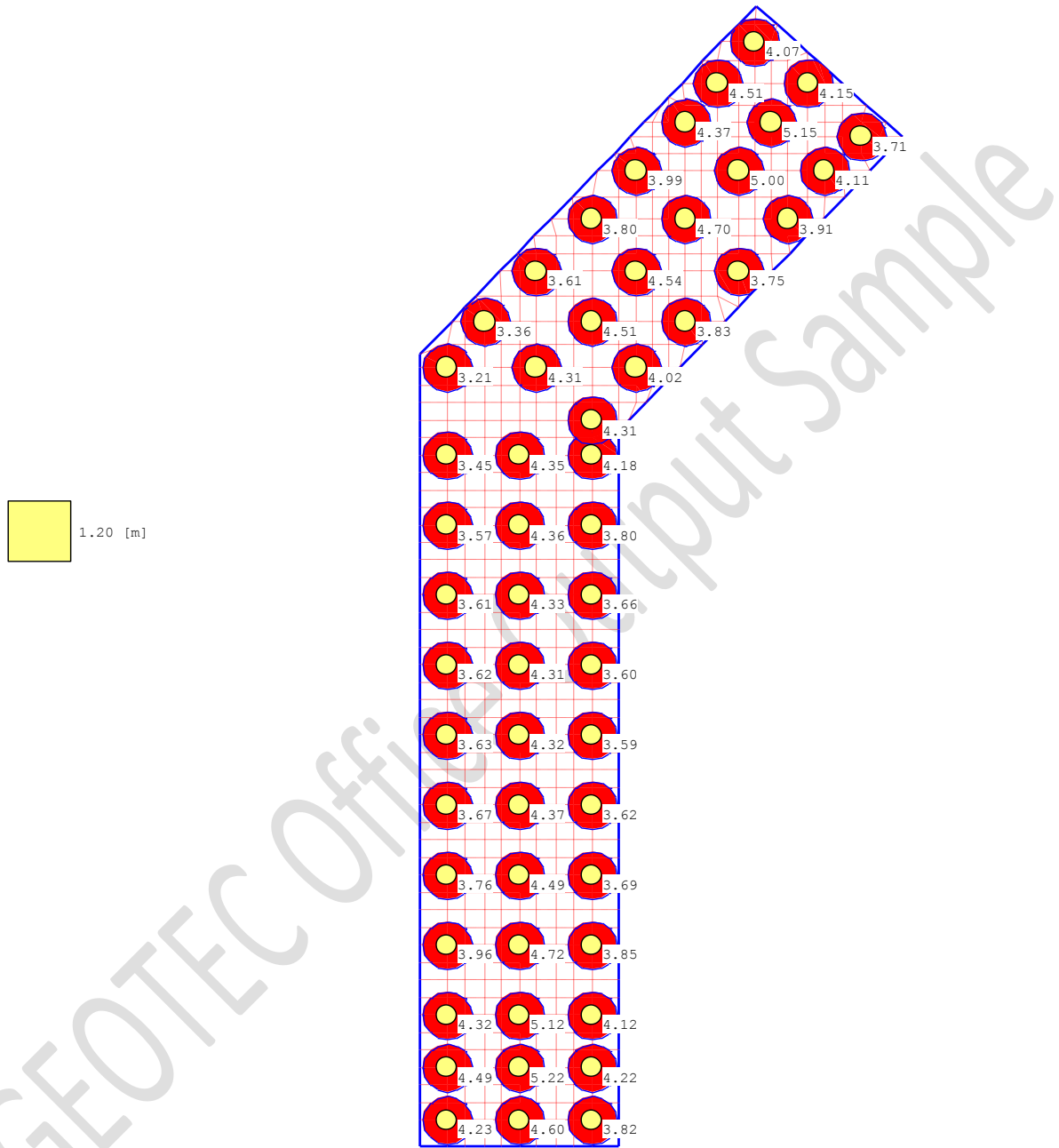















Punching shear stress ratio R_{pa} [%]

Max. R_{pa} = 5.22 at column 5, Min. R_{pa} = 3.21 at column 34

GEOTEC Software P. O. Box 465, Port-Said, Egypt* Tel. +2066-3609247	
Scale 1:345 File: Tunnel floor design Page No. :	Title: Pile foundation design of the tunnel-right side Date: 25/09/2010 Project: Tarut bridge, Qatif city- Saudi Arabia

Tarut Bridge - Analysis and design of foundation

-  Group 1
-  Group 2
-  Group 3
-  Group 4
-  Group 5
-  Group 6
-  Group 7
-  Group 8
-  Group 9
-  Group 10
-  Group 11
-  Group 12
-  Group 13
-  Group >= 14

Method (2)
Modulus of subgrade reaction is defined by the user

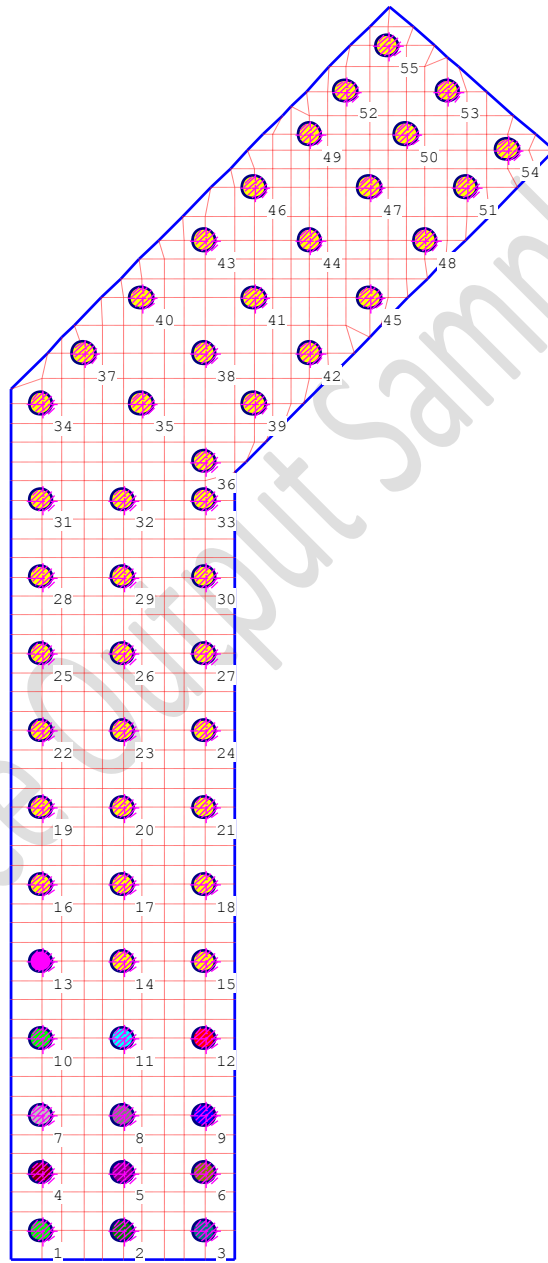

Pile locations and groups
No. of pile groups = 55

GEOTEC Software P. O. Box 465, Port-Said, Egypt* Tel. +2066-3609247	
Scale 1:345 File: Tunnel floor design Page No. :	Title: Pile foundation design of the tunnel-right side Date: 25/09/2010 Project: Tarut bridge, Qatif city- Saudi Arabia

Tarut Bridge - Analysis and design of foundation

Method (2)

Modulus of subgrade reaction is defined by the user

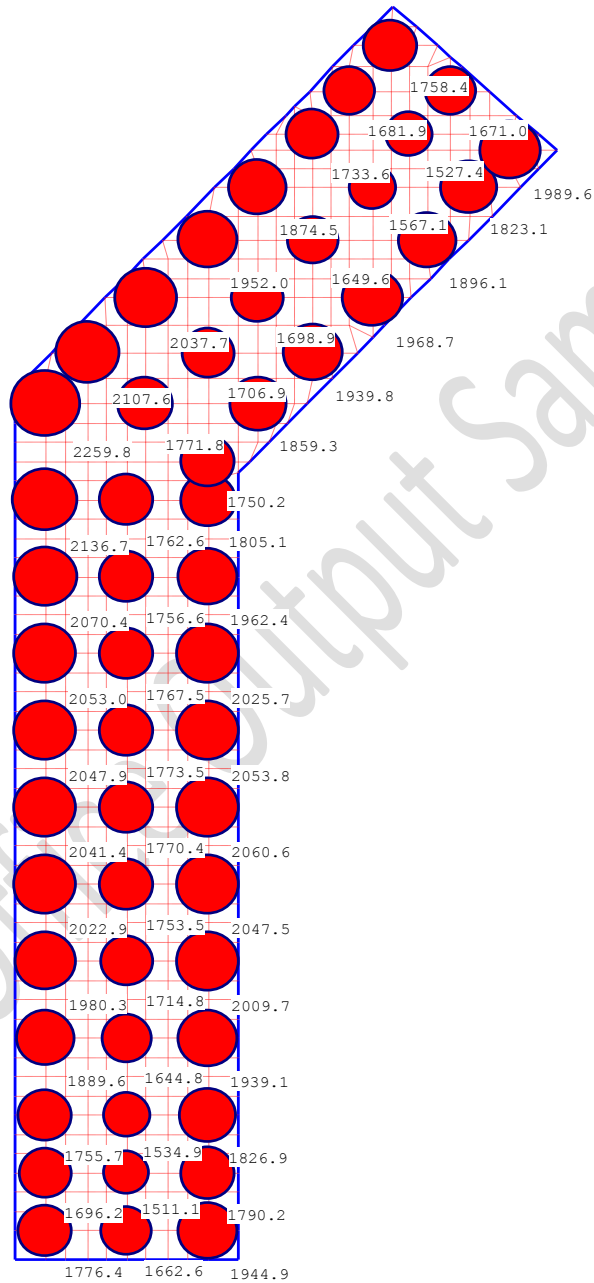

Support reactions V [kN]

Max. V = 2259.8 at node 532, Min. V = 1511.1 at node 170, Sum = 101813.8

GEOTEC Software P. O. Box 465, Port-Said, Egypt* Tel. +2066-3609247	
Scale 1:345 File: Tunnel floor design Page No.:	Title: Pile foundation design of the tunnel-right side Date: 25/09/2010 Project: Tarut bridge, Qatif city- Saudi Arabia

Tarut Bridge - Analysis and design of foundation

Method (2)

Modulus of subgrade reaction is defined by the user

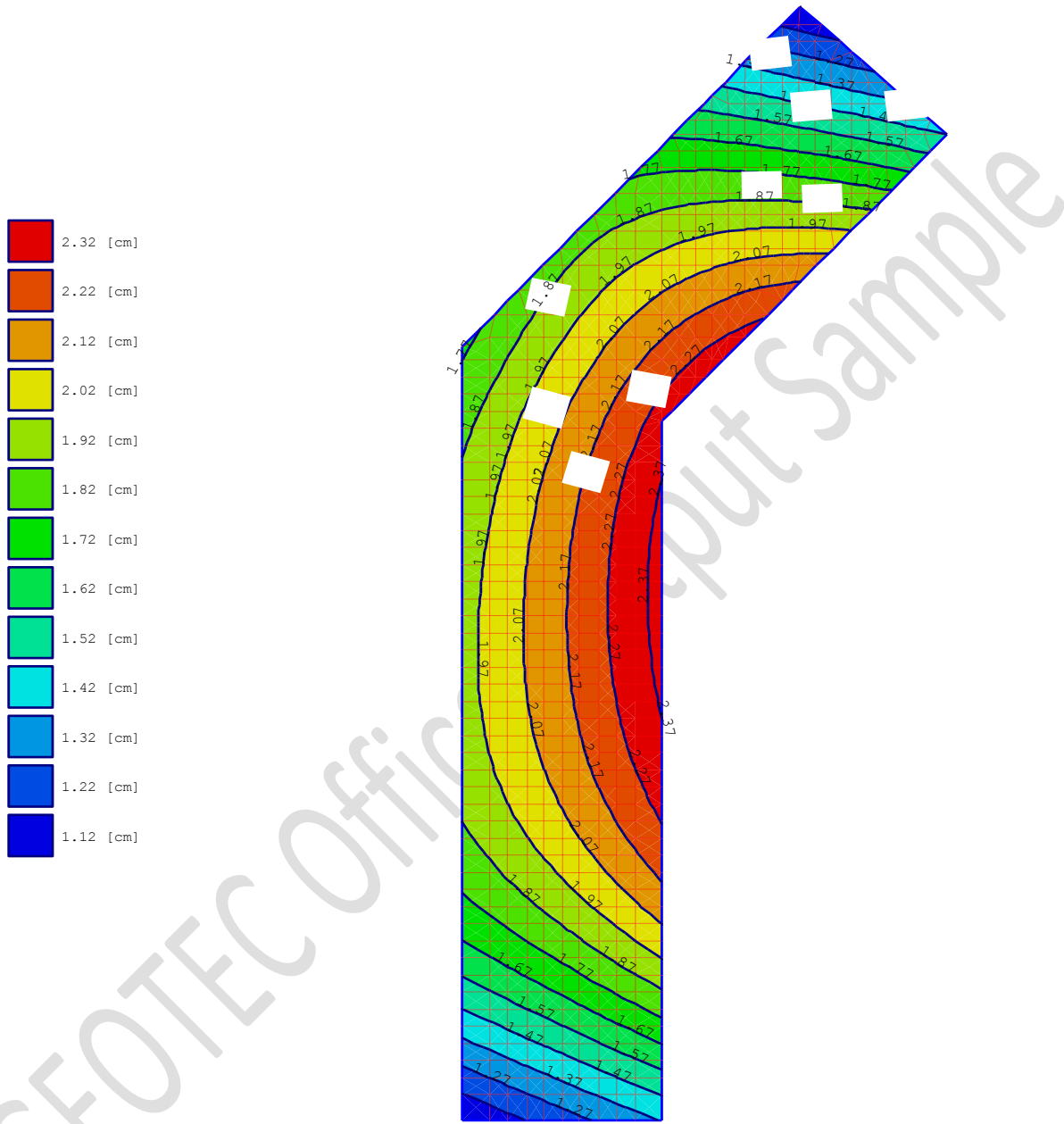

Settlements [cm]

Max. $s = 2.41$ at node 45, Min. $s = 1.07$ at node 5

GEOTEC Software P. O. Box 465, Port-Said, Egypt* Tel. +2066-3609247	
Scale 1:345 File: Tunnel floor design Page No.:	Title: Pile foundation design of the tunnel-right side Date: 25/09/2010 Project: Tarut bridge, Qatif city- Saudi Arabia

Method (2)

Modulus of subgrade reaction is defined by the user

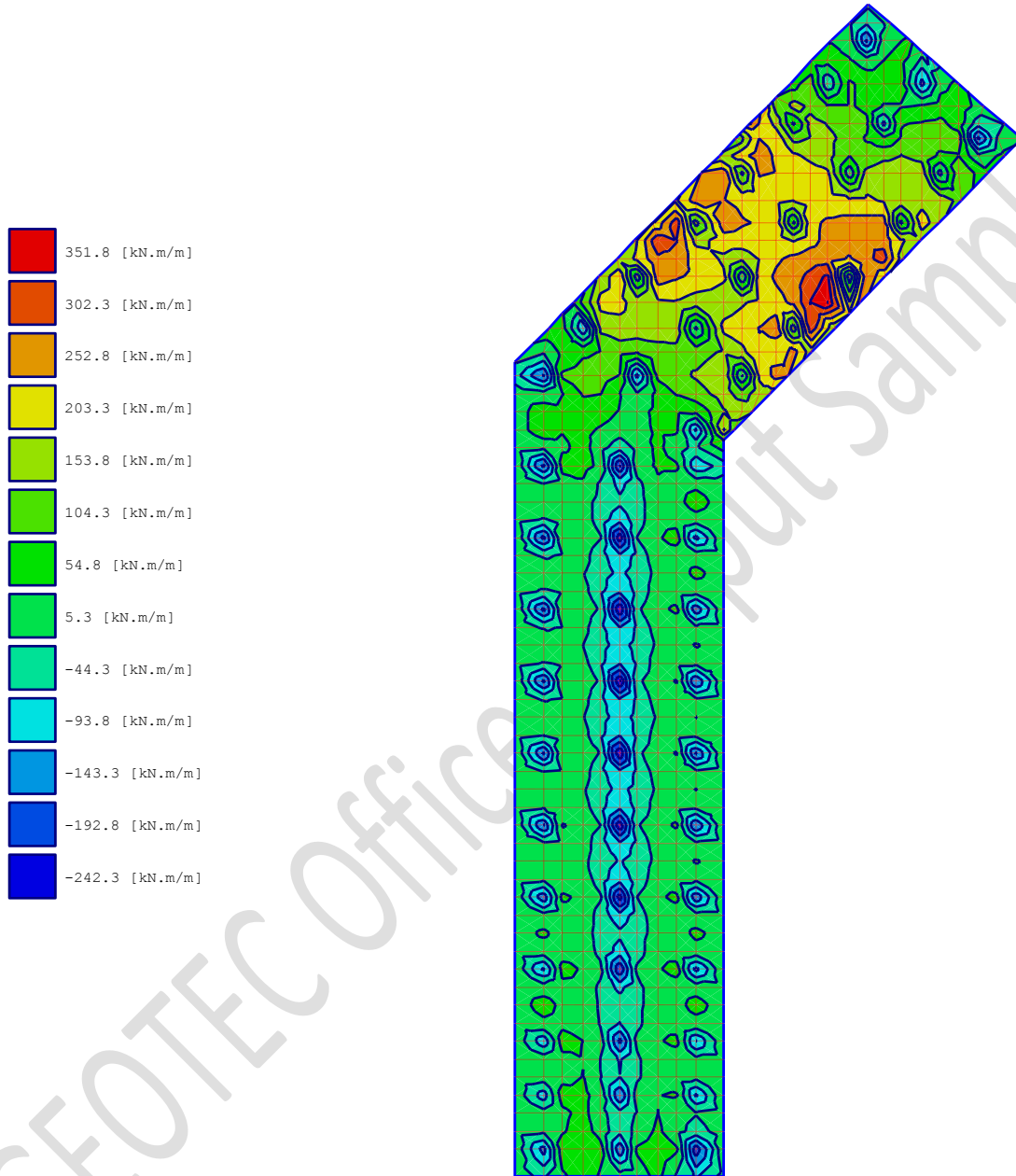

Moments m_x [kN.m/m]

Max. m_x = 376.8 at node 585, Min. m_x = -267.0 at node 377

GEOTEC Software P. O. Box 465, Port-Said, Egypt* Tel. +2066-3609247	
Scale 1:345 File: Tunnel floor design Page No. :	Title: Pile foundation design of the tunnel-right side Date: 25/09/2010 Project: Tarut bridge, Qatif city- Saudi Arabia

Method (2)

Modulus of subgrade reaction is defined by the user

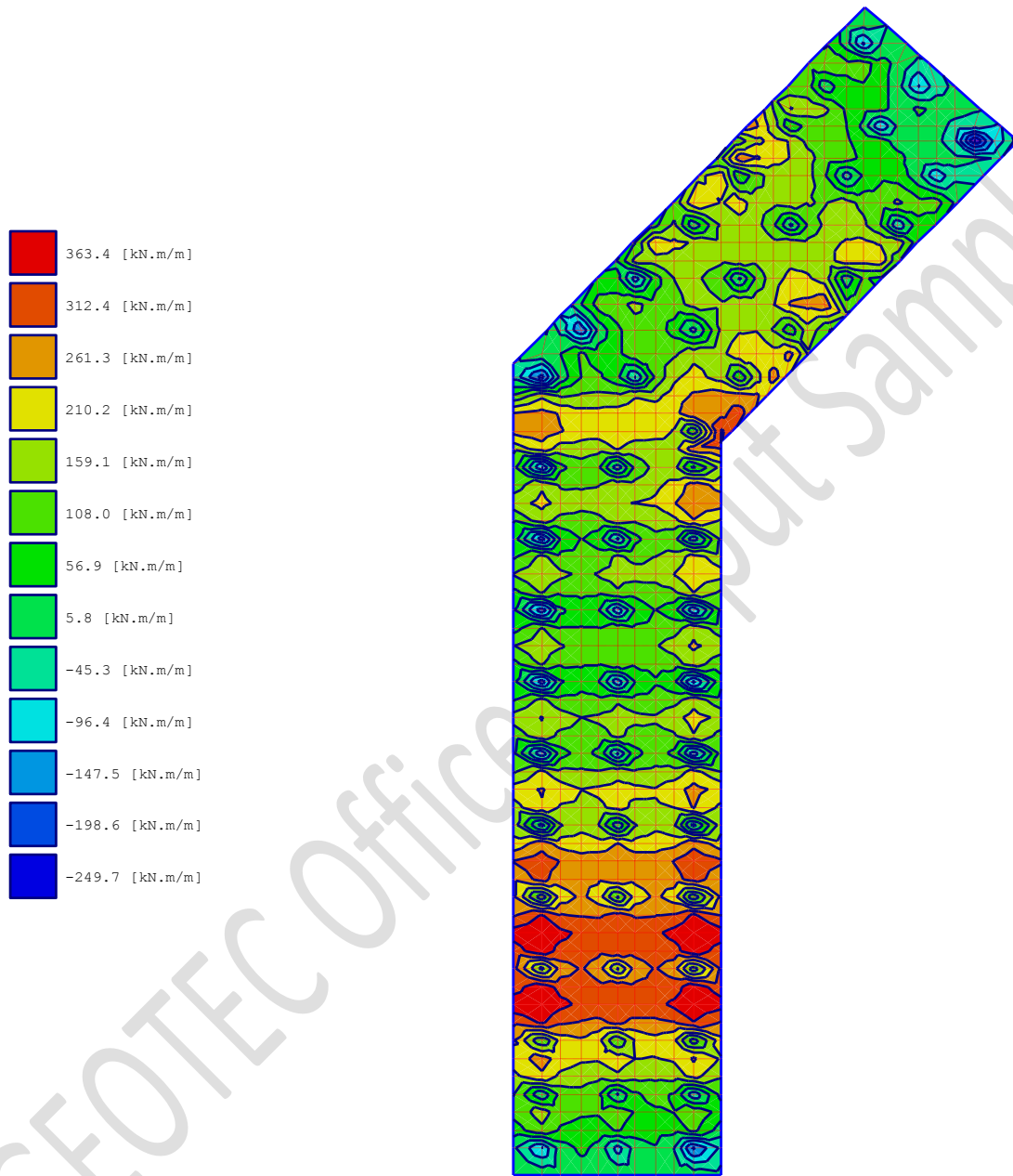

Moments m_y [kN.m/m]

Max. $m_y = 388.9$ at node 255, Min. $m_y = -275.3$ at node 696

GEOTEC Software P. O. Box 465, Port-Said, Egypt* Tel. +2066-3609247	
Scale 1:345 File: Tunnel floor design Page No.:	Title: Pile foundation design of the tunnel-right side Date: 25/09/2010 Project: Tarut bridge, Qatif city- Saudi Arabia

Tarut Bridge - Analysis and design of foundation

Method (2)

Modulus of subgrade reaction is defined by the user

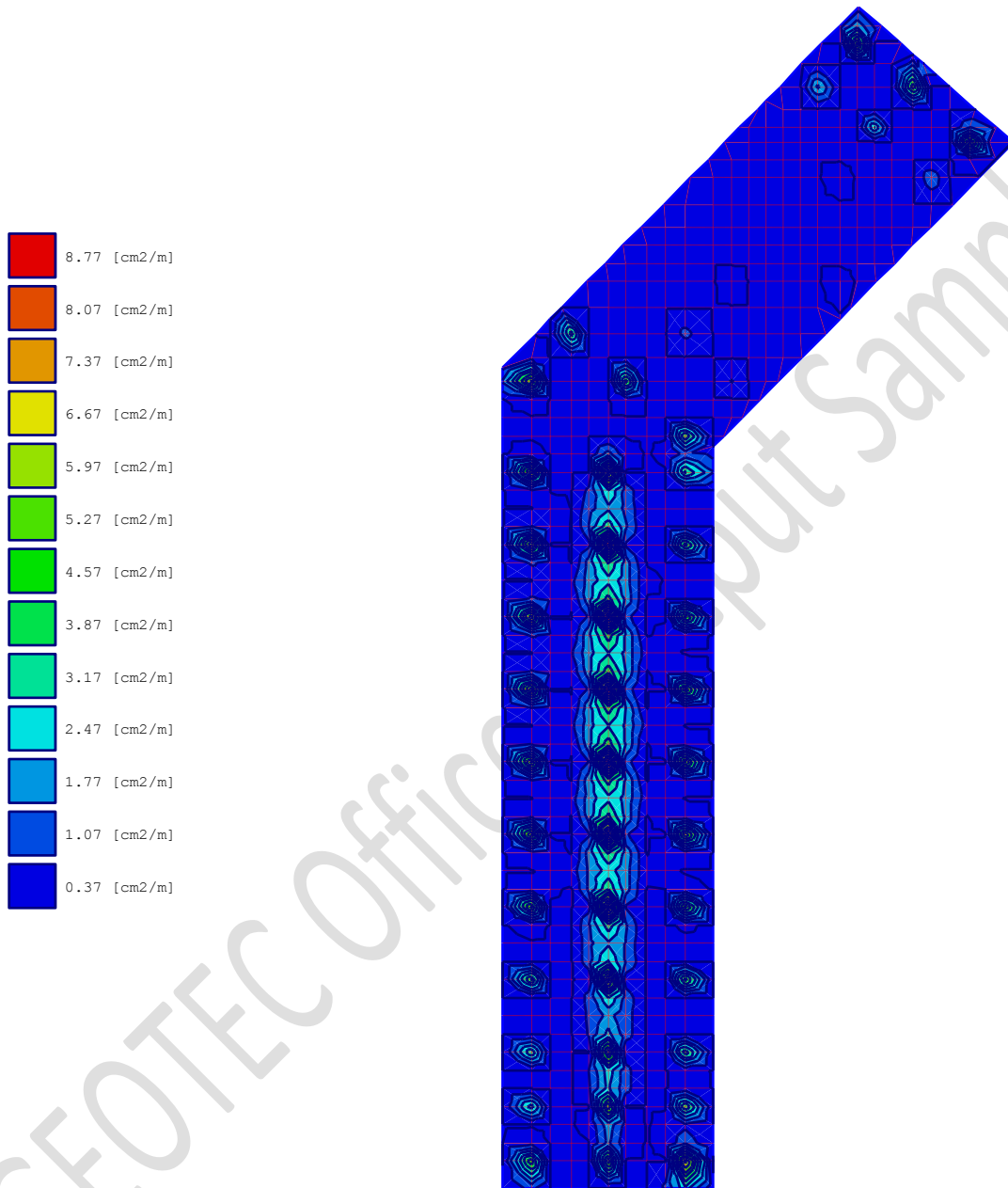

Top reinforcement in x-direction A_{s_topx} [cm²/m]

Max. A_{s_topx} = 9.06 at node 377, Min. A_{s_topx} = 0.02 at node 249

GEOTEC Software P. O. Box 465, Port-Said, Egypt* Tel. +2066-3609247	
Scale 1:345 File: Tunnel floor design Page No. :	Title: Pile foundation design of the tunnel-right side Date: 25/09/2010 Project: Tarut bridge, Qatif city- Saudi Arabia

Method (2)

Modulus of subgrade reaction is defined by the user

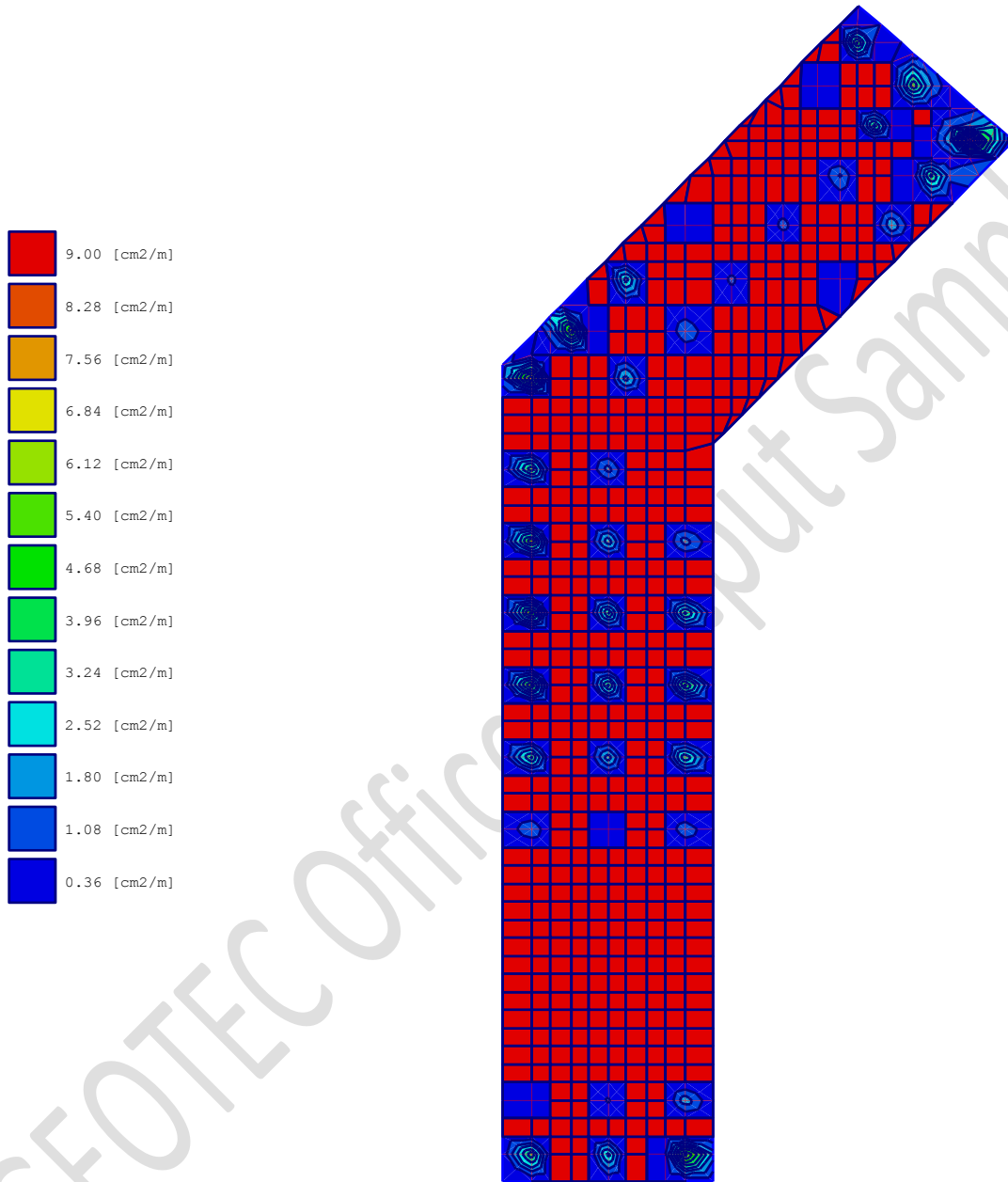

Top reinforcement in y-direction A_{s_topy} [cm²/m]

Max. A_{s_topy} = 9.35 at node 696, Min. A_{s_topy} = 0.00 at node 2

GEOTEC Software
P. O. Box 465, Port-Said, Egypt* Tel. +2066-3609247

Scale 1:345	Title: Pile foundation design of the tunnel-right side
File: Tunnel floor design	Date: 25/09/2010
Page No. :	Project: Tarut bridge, Qatif city- Saudi Arabia

Method (2)

Modulus of subgrade reaction is defined by the user

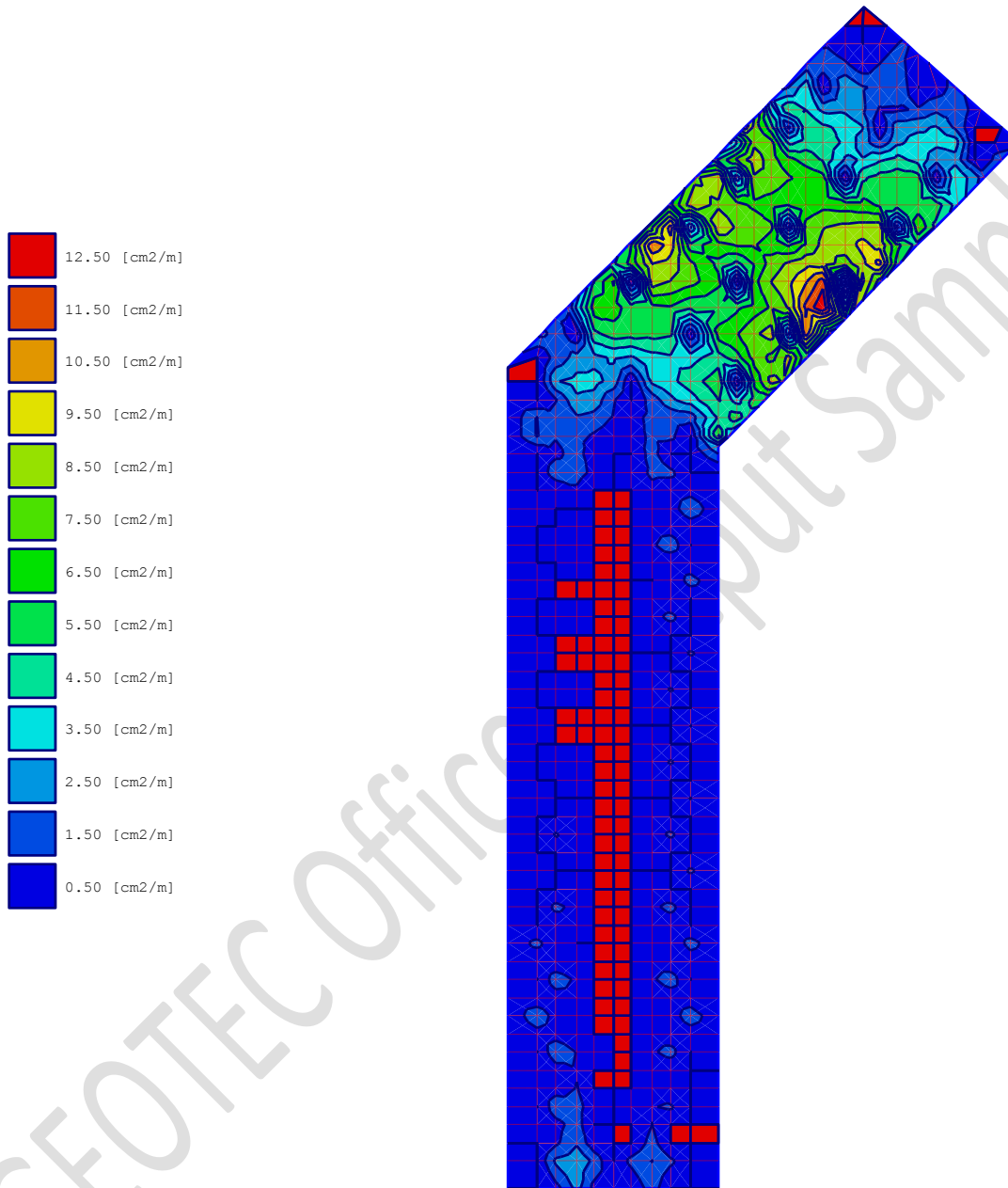

Bottom reinforcement in x-direction A_{s_botx} [cm²/m]

Max. A_{s_botx} = 12.95 at node 585, Min. A_{s_botx} = 0.00 at node 20

GEOTEC Software P. O. Box 465, Port-Said, Egypt* Tel. +2066-3609247	
Scale 1:345 File: Tunnel floor design Page No. :	Title: Pile foundation design of the tunnel-right side Date: 25/09/2010 Project: Tarut bridge, Qatif city- Saudi Arabia

Method (2)

Modulus of subgrade reaction is defined by the user

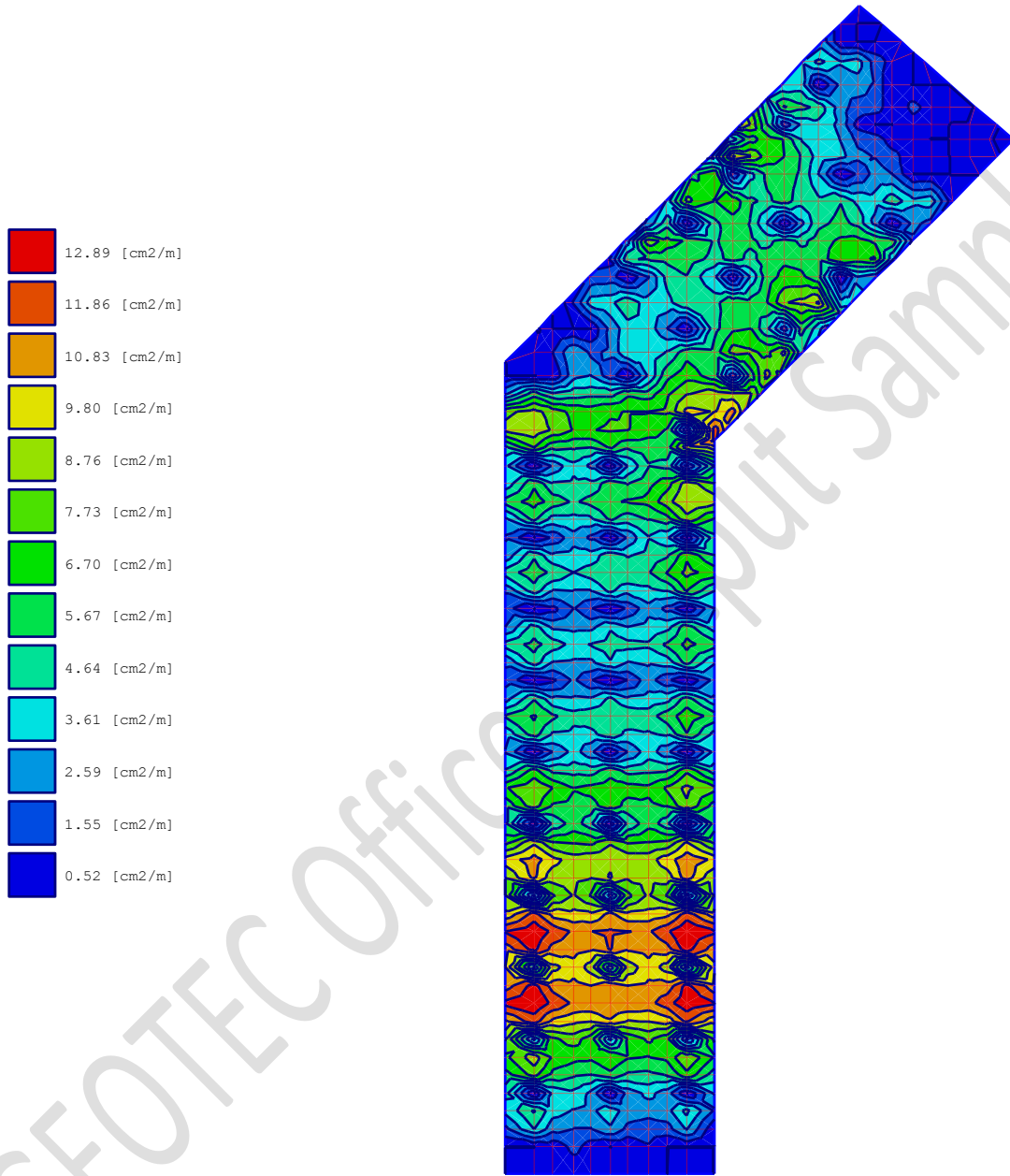

Bottom reinforcement in y-direction A_{s_boty} [cm²/m]

Max. A_{s_boty} = 13.38 at node 255, Min. A_{s_boty} = 0.01 at node 14

GEOTEC Software
P. O. Box 465, Port-Said, Egypt* Tel. +2066-3609247

Scale 1:345	Title: Pile foundation design of the tunnel-right side
File: Tunnel floor design	Date: 25/09/2010
Page No.:	Project: Tarut bridge, Qatif city- Saudi Arabia

Method (2)

Modulus of subgrade reaction is defined by the user

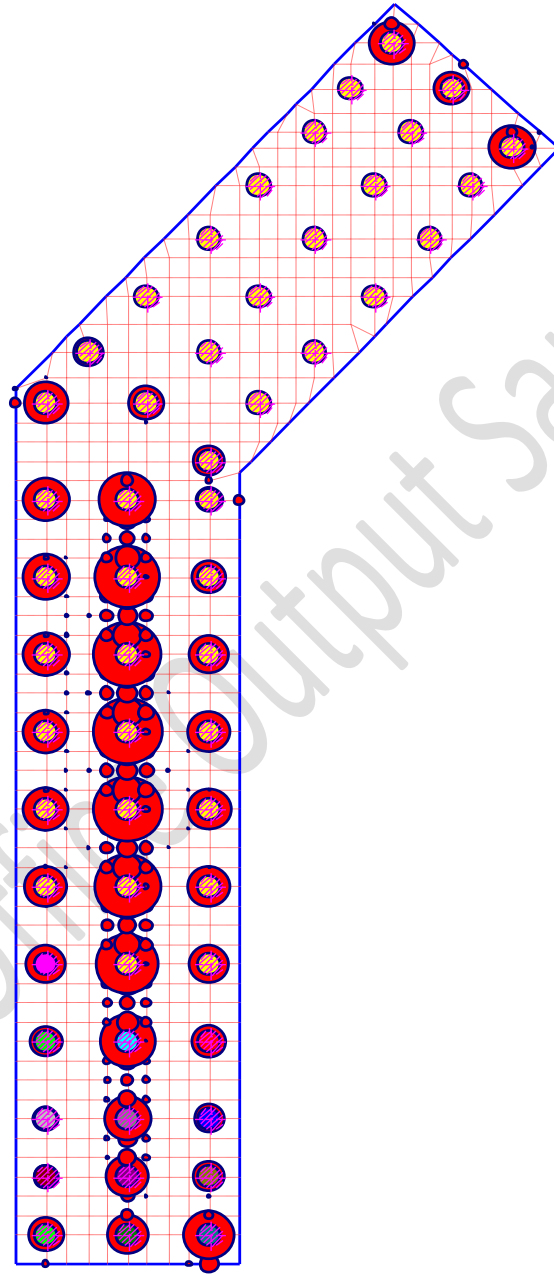

Top reinforcement in x-direction A_{s_topx} [cm²/m]

Max. A_{s_topx} = 9.06 at node 377, Min. A_{s_topx} = 0.02 at node 249

GEOTEC Software P. O. Box 465, Port-Said, Egypt* Tel. +2066-3609247	
Scale 1:345	Title: Pile foundation design of the tunnel-right side
File: Tunnel floor design	Date: 25/09/2010
Page No.:	Project: Tarut bridge, Qatif city- Saudi Arabia

Method (2)

Modulus of subgrade reaction is defined by the user

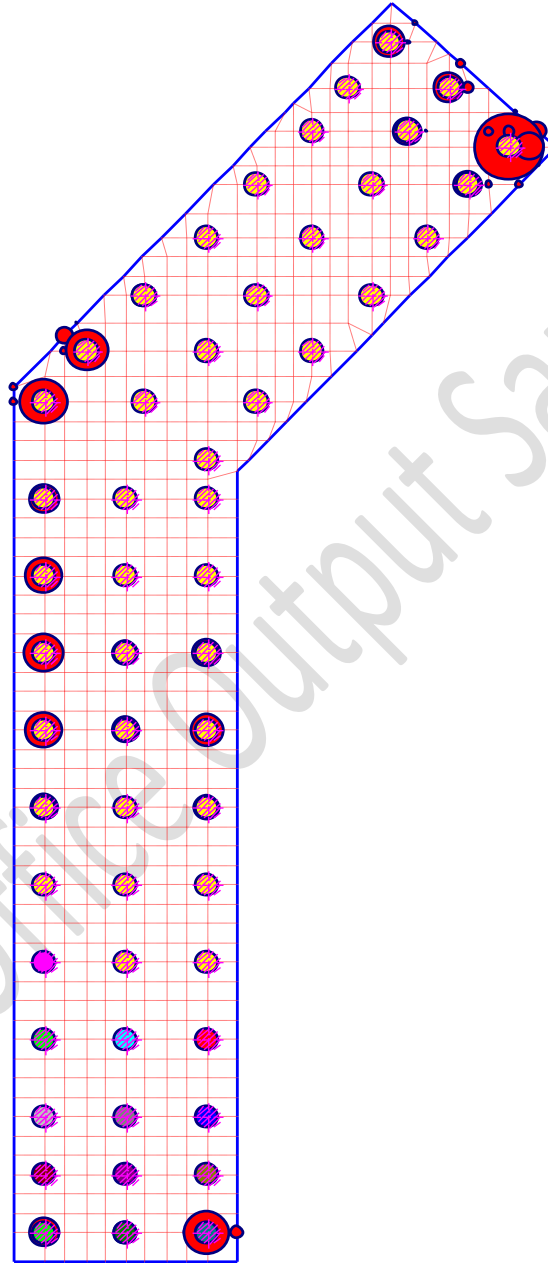

Top reinforcement in y-direction As_{topy} [cm²/m]

Max. As_{topy} = 9.35 at node 696, Min. As_{topy} = 0.00 at node 2

GEOTEC Software P. O. Box 465, Port-Said, Egypt* Tel. +2066-3609247	
Scale 1:345	Title: Pile foundation design of the tunnel-right side
File: Tunnel floor design	Date: 25/09/2010
Page No.:	Project: Tarut bridge, Qatif city- Saudi Arabia

Method (2)

Modulus of subgrade reaction is defined by the user

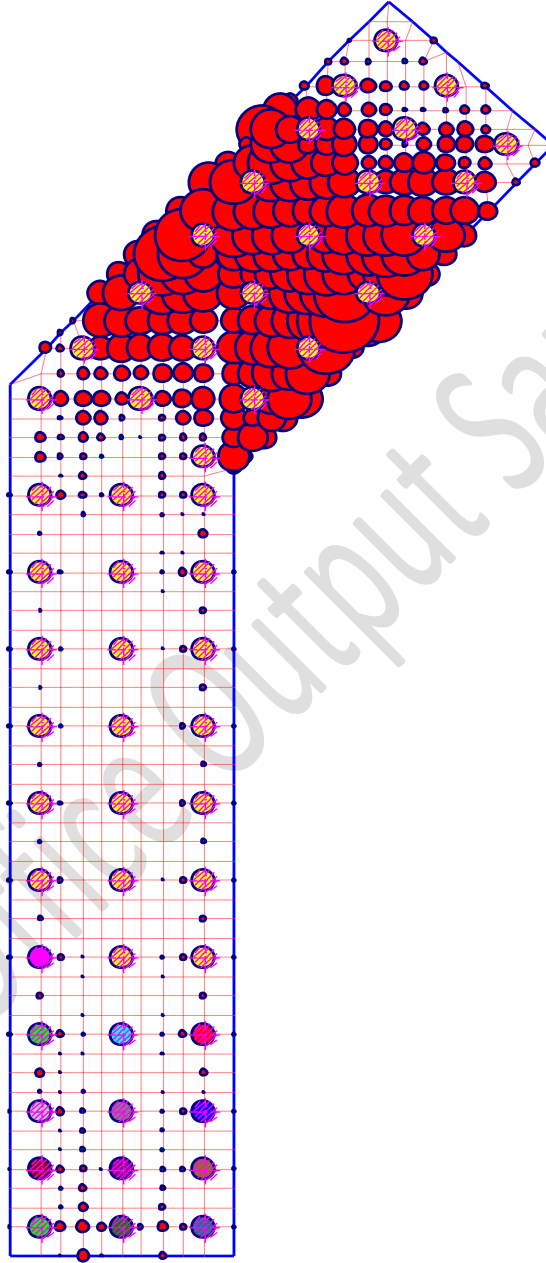

Bottom reinforcement in x-direction A_{s_botx} [cm²/m]

Max. A_{s_botx} = 12.95 at node 585, Min. A_{s_botx} = 0.00 at node 20

GEOTEC Software P. O. Box 465, Port-Said, Egypt* Tel. +2066-3609247	
Scale 1:345	Title: Pile foundation design of the tunnel-right side
File: Tunnel floor design	Date: 25/09/2010
Page No. :	Project: Tarut bridge, Qatif city- Saudi Arabia

Method (2)

Modulus of subgrade reaction is defined by the user

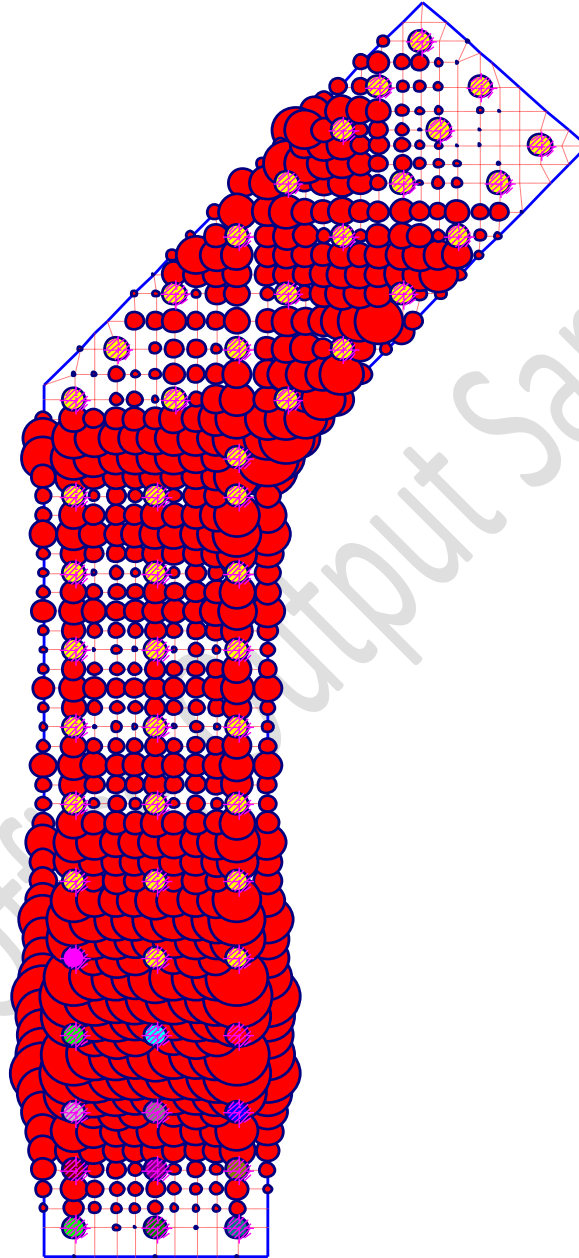

Bottom reinforcement in y-direction A_{s_boty} [cm²/m]

Max. A_{s_boty} = 13.38 at node 255, Min. A_{s_boty} = 0.01 at node 14

GEOTEC Software

P. O. Box 465, Port-Said, Egypt* Tel. +2066-3609247

Scale 1:345

File: Tunnel floor design

Page No. :

Title: Pile foundation design of the tunnel-right side

Date: 25/09/2010

Project: Tarut bridge, Qatif city- Saudi Arabia

17 Check for uplift - Righth tunnel

This section has be omitted

18 References

- [1] *Bakhoun, M.* (1992): Structural Mechanics. Cairo, Egypt.
- [2] *Bowels, J.* (1977): "Foundation Analysis and Design", McGRAW-HILL
- [3] *Denver H.* (1982): "Modulus of elasticity for sand determined by SPT and CPT", Proceedings of the second European Symposium on penetration testing.
- [4] *ECP 203* (2007): The Egyptian Code of Practice, Design and Construction of Reinforced Concrete Structures. (in Arabic).
- [5] *ECP 197* (1995): Egyptian Code for Soil Mechanics - Design and Construction of Foundations, Part 4, Deep Foundations (in Arabic).
- [6] *El Gendy, M./ Hanisch, J./ Kany, M.* (2006): Empirische nichtlineare Berechnung von Kombinierten Pfahl-Plattengründungen, Bautechnik 9/06.
- [7] *Kany, M./ El Gendy, M./ El Gendy, A.* (2008): Design and analysis of foundation by FE-Method, program *ELPLA*, Zirndorf.
- [8] *UBC* (1991): "Uniform Building Code", International Conference of Building Officials, California, USA, 1991.
- [9] *Al-Haddad, M./ Siddiqi, G.S.* (1995): "Seismic Design Recommendations for Building Structures in Saudi Arabia", Journal of King Saud University – Engineering Science [1], Vol. 7, pp. 25-45, Riyadh, 1995.